

# JVC

## SERVICE MANUAL

### CD/CASSETTE RECEIVER

## KW-XC400, KW-XC407

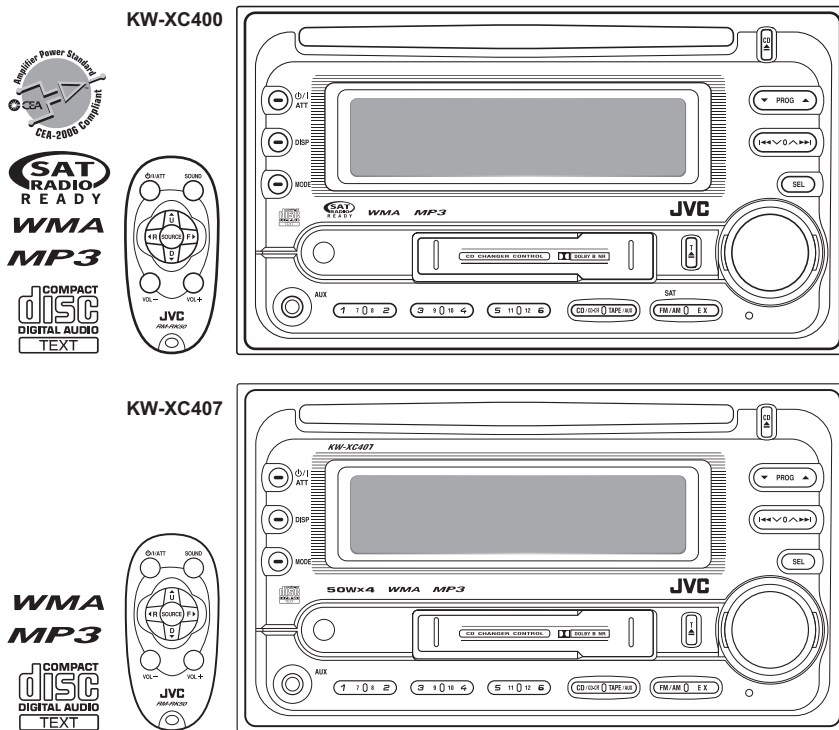

<b>KW-XC400</b>
<b>Area suffix</b>
J ----- Northern America
<b>KW-XC407</b>
<b>Area suffix</b>
EE ----- Russian Federation

Lead free solder used in the board (material : Sn-Ag-Cu, melting point : 219 Centigrade)

### TABLE OF CONTENTS

1	PRECAUTIONS .....	1-4
2	SPECIFIC SERVICE INSTRUCTIONS .....	1-6
3	DISASSEMBLY .....	1-7
4	ADJUSTMENT .....	1-13
5	TROUBLESHOOTING .....	1-16

# SPECIFICATION

## KW-XC400

AUDIO AMPLIFIER SECTION		
Power Output		18 W RMS × 4 Channels at 4 Ω and [ $\leq$ ] 1% THD+N
Signal to Noise Ratio		80 dBA (reference: 1 W into 4 Ω)
Load Impedance		4 Ω (4 Ω to 8 Ω allowance)
Equalizer Control Range	Low	±12 dB (60 Hz, 80 Hz, 100 Hz, 120 Hz)
	Mid	±12 dB
	High	±12 dB (8 kHz, 10 kHz, 12 kHz, 15 kHz)
Frequency Response		40 Hz to 20 000 Hz
Line-Out Level/Impedance		2.0 V/20 kΩ load (full scale)
Output Impedance		1 kΩ
Other Terminals		CD changer, AUX (auxiliary) input jack, Steering wheel remote input
TUNER SECTION		
Frequency Range	FM	87.5 MHz to 107.9 MHz (with channel interval set to 100 kHz or 200 kHz) 87.5 MHz to 108.0 MHz (with channel interval set to 50 kHz)
	AM	530 kHz to 1 710 kHz (with channel interval set to 10 kHz) 531 kHz to 1 602 kHz (with channel interval set to 9 kHz)
FM Tuner	Usable Sensitivity	11.3 dBf (1.0 μV/75 Ω)
	50 dB Quieting Sensitivity	16.3 dBf (1.8 μV/75 Ω)
	Alternate Channel Selectivity (400 kHz)	65 dB
	Frequency Response	40 Hz to 15 000 Hz
	Stereo Separation	35 dB
	Capture Ratio	1.5 dB
AM Tuner	Sensitivity	20 μV
	Selectivity	35 dB
CD PLAYER SECTION		
Type		Compact disc player
Signal Detection System		Non-contact optical pickup (semiconductor laser)
Number of Channels		2 channels (stereo)
Frequency Response		5 Hz to 20 000 Hz
Dynamic Range		96 dB
Signal-to-Noise Ratio		98 dB
Wow and Flutter		Less than measurable limit
MP3 Decoding Format		MPEG1/2 Audio Layer 3 Max. Bit Rate: 320 kbps
WMA (Windows Media® Audio) Decoding Format		Max. Bit Rate: 192 kbps
CASSETTE DECK SECTION		
Wow and Flutter		0.1 % (WRMS)
Fast-Wind Time		100 sec. (C-60)
Frequency Response		30 Hz to 16 000 Hz (Normal tape)
Signal-to-Noise Ratio (Normal tape)	Dolby B NR ON	65 dB
	Dolby B NR OFF	56 dB
Stereo Separation		40 dB
GENERAL		
Power Requirement	Operating Voltage	DC 14.4 V (11 V to 16 V allowance)
Grounding System		Negative ground
Allowable Operating Temperature		0°C to +40°C (32°F to 104°F)
Dimensions (W × H × D)	Installation Size (approx.)	178 mm × 100 mm × 158 mm (7-1/16" × 3-15/16" × 6-1/4")
	Set Size (approx.)	178 mm × 100 mm × 175 mm (7-1/16" × 3-15/16" × 6-15/16")
Mass (approx.)		2.3 kg (5.1 lbs) (excluding accessories)

Design and specifications are subject to change without notice.

**KW-XC407**

<b>AUDIO AMPLIFIER SECTION</b>		
Maximum Power Output	Front	50 W per channel
	Rear	50 W per channel
Continuous Power Output (RMS)	Front	19 W per channel into 4 $\Omega$ , 40 Hz to 20 000 Hz at no more than 0.8% total harmonic distortion.
	Rear	19 W per channel into 4 $\Omega$ , 40 Hz to 20 000 Hz at no more than 0.8% total harmonic distortion.
Load Impedance		4 $\Omega$ (4 $\Omega$ to 8 $\Omega$ allowance)
Equalizer Control Range	Low	$\pm 12$ dB (60 Hz, 80 Hz, 100 Hz, 120 Hz)
	Mid	$\pm 12$ dB
	High	$\pm 12$ dB (8 kHz, 10 kHz, 12 kHz, 15 kHz)
Frequency Response		40 Hz to 20 000 Hz
Signal-to-Noise Ratio		70 dB
Line-Out Level/Impedance		2.0 V/20 k $\Omega$ load (full scale)
Output Impedance		1 k $\Omega$
Other terminals		CD changer, AUX (auxiliary) input jack
<b>TUNER SECTION</b>		
Frequency Range	FM	87.5 MHz to 108.0 MHz
	AM	531 kHz to 1 602 kHz
FM Tuner	Usable Sensitivity	11.3 dBf (1.0 $\mu$ V/75 $\Omega$ )
	50 dB Quieting Sensitivity	16.3 dBf (1.8 $\mu$ V/75 $\Omega$ )
	Alternate Channel Selectivity (400 kHz)	65 dB
	Frequency Response	40 Hz to 15 000 Hz
	Stereo Separation	30 dB
	Capture Ratio	1.5 dB
AM Tuner	Sensitivity	20 $\mu$ V
	Selectivity	35 dB
<b>CD PLAYER SECTION</b>		
Type		Compact disc player
Signal Detection System		Non-contact optical pickup (semiconductor laser)
Number of Channels		2 channels (stereo)
Frequency Response		5 Hz to 20 000 Hz
Dynamic Range		96 dB
Signal-to-Noise Ratio		98 dB
Wow and Flutter		Less than measurable limit
MP3 Decoding Format		MPEG1/2 Audio Layer 3 Max. Bit Rate: 320 kbps
WMA (Windows Media <sup>®</sup> Audio) Decoding Format		Max. Bit Rate: 192 kbps
<b>CASSETTE DECK SECTION</b>		
Wow and Flutter		0.1 % (WRMS)
Fast-Wind Time		100 sec. (C-60)
Frequency Response		30 Hz to 16 000 Hz (Normal tape)
Signal-to-Noise Ratio (Normal tape)	Dolby B NR ON	65 dB
	Dolby B NR OFF	56 dB
Stereo Separation		40 dB
<b>GENERAL</b>		
Power Requirement	Operating Voltage	DC 14.4 V (11 V to 16 V allowance)
Grounding System		Negative ground
Allowable Operating Temperature		0°C to +40°C
Dimensions (W $\times$ H $\times$ D)	Installation Size (approx.)	178 mm $\times$ 100 mm $\times$ 158 mm
	Set Size (approx.)	178 mm $\times$ 100 mm $\times$ 175 mm
Mass (approx.)		2.3 kg (excluding accessories)

Design and specifications are subject to change without notice.

# SECTION 1 PRECAUTIONS

## 1.1 Safety Precautions

 **CAUTION** Burrs formed during molding may be left over on some parts of the chassis. Therefore, pay attention to such burrs in the case of performing repair of this system.

 **CAUTION** Please use enough caution not to see the beam directly or touch it in case of an adjustment or operation check.

## 1.2 Preventing static electricity

Electrostatic discharge (ESD), which occurs when static electricity stored in the body, fabric, etc. is discharged, can destroy the laser diode in the traverse unit (optical pickup). Take care to prevent this when performing repairs.

### 1.2.1 Grounding to prevent damage by static electricity

Static electricity in the work area can destroy the optical pickup (laser diode) in devices such as CD players.

Be careful to use proper grounding in the area where repairs are being performed.

(1) Ground the workbench

Ground the workbench by laying conductive material (such as a conductive sheet) or an iron plate over it before placing the traverse unit (optical pickup) on it.

(2) Ground yourself

Use an anti-static wrist strap to release any static electricity built up in your body.

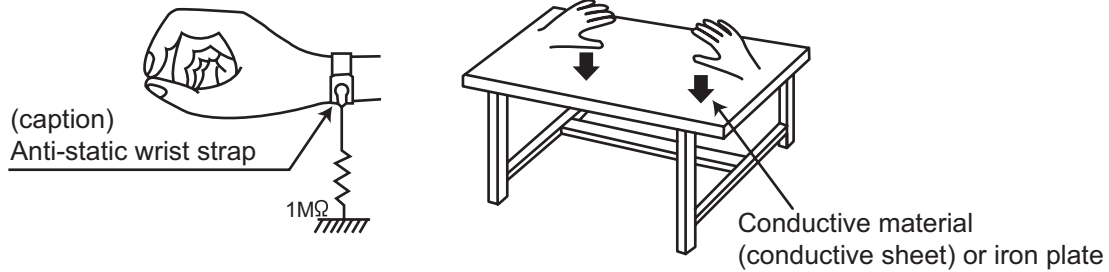

(3) Handling the optical pickup

- In order to maintain quality during transport and before installation, both sides of the laser diode on the replacement optical pickup are shorted. After replacement, return the shorted parts to their original condition. (Refer to the text.)
- Do not use a tester to check the condition of the laser diode in the optical pickup. The tester's internal power source can easily destroy the laser diode.

## 1.3 Handling the traverse unit (optical pickup)

- (1) Do not subject the traverse unit (optical pickup) to strong shocks, as it is a sensitive, complex unit.
- (2) Cut off the shorted part of the flexible cable using nippers, etc. after replacing the optical pickup. For specific details, refer to the replacement procedure in the text. Remove the anti-static pin when replacing the traverse unit. Be careful not to take too long a time when attaching it to the connector.
- (3) Handle the flexible cable carefully as it may break when subjected to strong force.
- (4) It is not possible to adjust the semi-fixed resistor that adjusts the laser power. Do not turn it.

## 1.4 Attention when traverse unit is decomposed

**\*Please refer to "Disassembly method" in the text for the CD pickup unit.**

- Apply solder to the short land before the flexible wire is disconnected from the connector on the CD pickup unit. (If the flexible wire is disconnected without applying solder, the CD pickup may be destroyed by static electricity.)
- In the assembly, be sure to remove solder from the short land after connecting the flexible wire.

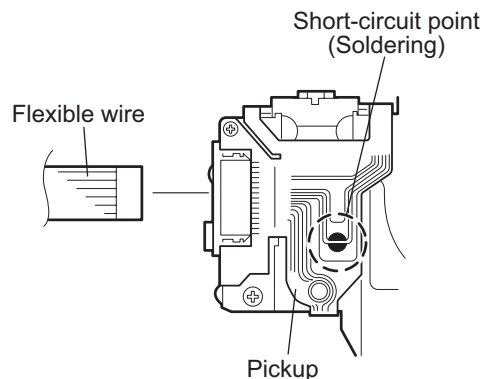

## **SECTION 2**

### **SPECIFIC SERVICE INSTRUCTIONS**

#### **2.1 CD mechanism and Cassette mechanism**

For the CD mechanism, please refer the mechanism manual TN2001-1013 (No.MY001).

For the Cassette mechanism, please refer the mechanism manual CDS-802JE3 (No.MY002).

## SECTION 3 DISASSEMBLY

### 3.1 Main body section

#### 3.1.1 Removing the front panel assembly

(See Figs.1 and 2)

- (1) From the both side of the main body, remove the two screws **A** attaching the front panel assembly. (See Figs.1 and 2.)
- (2) Release the four joints **a** and remove the front panel assembly in the direction of the arrow. (See Figs.1 and 2.)

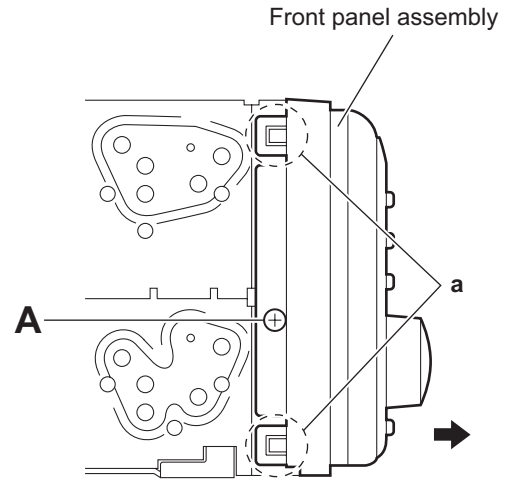

Fig.1

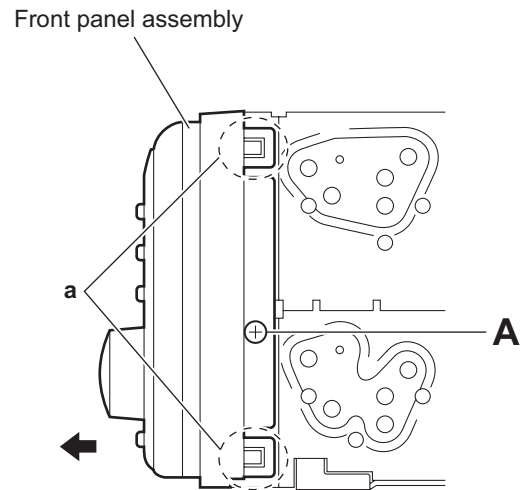

Fig.2

### 3.1.2 Removing the heat sink (See Figs.3 and 4)

- (1) From the back side of the main body, remove the six screws **B** attaching the heat sink. (See Fig.3.)
- (2) Remove the heat sink from the main body.

#### Note:

- Before attaching the heat sink, attach the cooling rubbers on the power amplifier IC. (See Fig.4)
- When attaching the heat sink, set the projections **b** on the rear bracket in the holes of the heat sink. (See Fig.3.)

### 3.1.3 Removing the rear bracket (See Fig.4)

- Remove the heat sink.
  - (1) From the back side of the main body, remove the seven screws **C**, two screws **D** and screw **E** attaching the rear bracket.
  - (2) Remove the rear bracket from the main body.

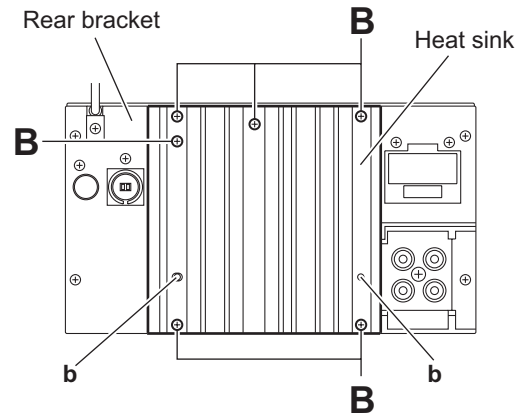

Fig.3

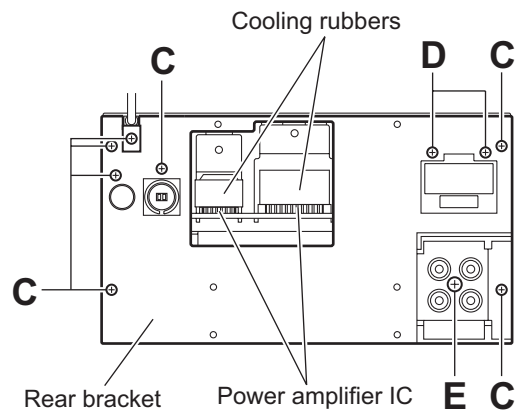

Fig.4

### 3.1.4 Removing the bottom chassis assembly (See Fig.5)

- Remove the front panel assembly, heat sink and rear bracket.
  - (1) From the bottom side of the main body, remove the four screws **F** attaching the bottom chassis assembly.
  - (2) Take out the bottom chassis assembly from the main body.

#### Reference:

When attaching the bottom chassis assembly, set the projections **c** of the main body in the holes of the bottom chassis assembly.

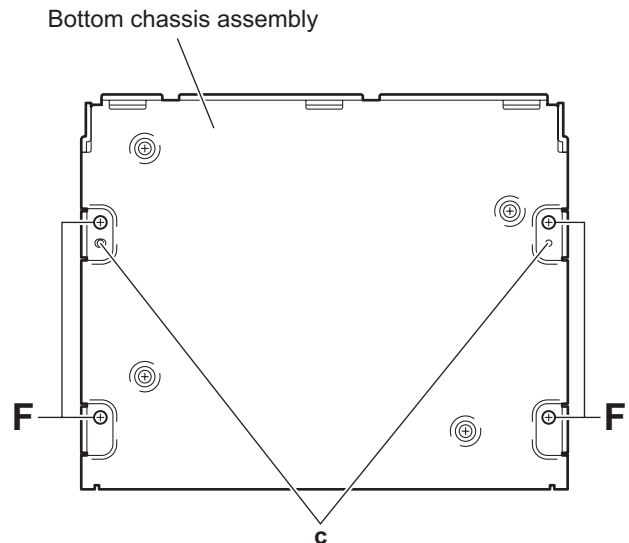

Fig.5



### 3.1.5 Removing the cassette mechanism control board (See Fig.6)

- Remove the front panel assembly, heat sink, rear bracket and bottom chassis assembly.
  - From the inside of the bottom chassis assembly, disconnect the card wire from the connector [CN403](#) on the cassette mechanism control board.
  - Disconnect the wire from the connector [CN402](#) on the cassette mechanism control board.
  - Remove the three screws **G** attaching the cassette mechanism control board.
  - Take out the cassette mechanism control board from the bottom chassis assembly.

#### Reference:

- When attaching the cassette mechanism control board, set the projections **d** of the bottom chassis assembly in the holes of the cassette mechanism control board.
- After attaching the cassette mechanism control board, fix the wire with the wire clamp as before.

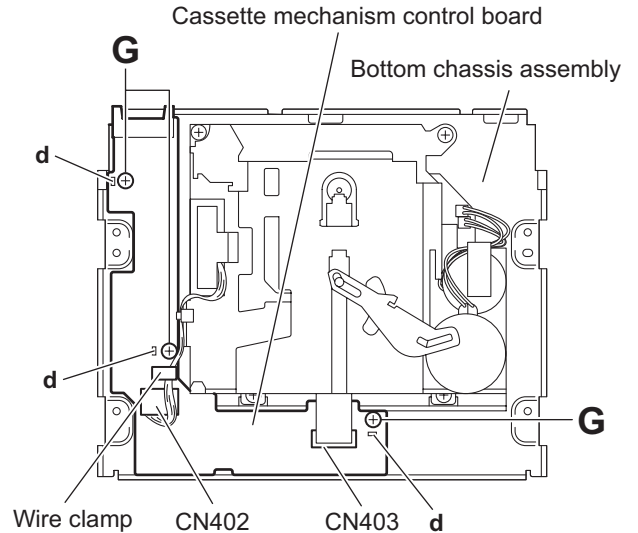

Fig.6

### 3.1.6 Removing the cassette mechanism assembly (See Fig.7)

- Remove the front panel assembly, heat sink, rear bracket and bottom chassis assembly.
  - From the inside of the bottom chassis assembly, disconnect the card wire from the connector [CN403](#) on the cassette mechanism control board.
  - Disconnect the wire from the connector [CN402](#) on the cassette mechanism control board.
  - Remove the four screws **H** attaching the cassette mechanism assembly.

#### Reference:

- After attaching the cassette mechanism control board, fix the wire with the wire clamp as before.

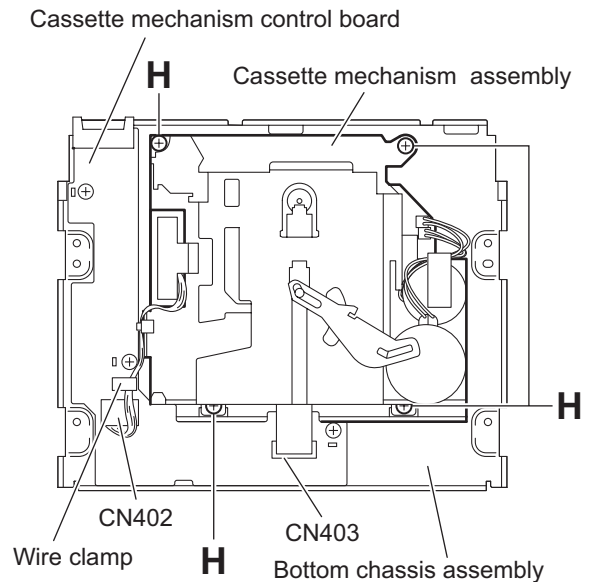

Fig.7

### 3.1.7 Removing the func board (See Fig.8)

- Remove the front panel assembly, heat sink, rear bracket and bottom chassis assembly.
  - From the bottom side of the main body, disconnect the wire from the connector [CN321](#) on the func board.
  - Remove the screw **J** and take out the func board from the main body.

### 3.1.8 Removing the middle chassis assembly (See Fig.8)

- Remove the front panel assembly, heat sink, rear bracket and bottom chassis assembly.
  - From the bottom side of the main body, remove the four screws **K** attaching the middle chassis assembly.
  - Disconnect the connector [CN705](#) of the main board on the middle chassis assembly from the CD mechanism assembly in an upward direction.

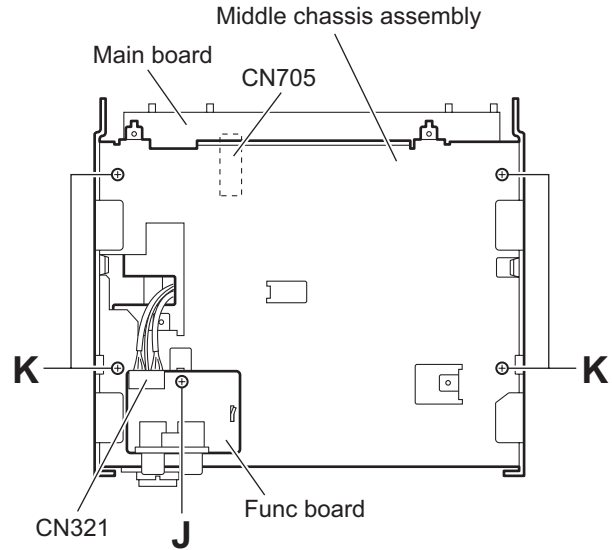

Fig.8

### 3.1.9 Removing the main board (See Fig.9)

- Remove the front panel assembly, heat sink, rear bracket, bottom chassis assembly and middle chassis assembly.
  - From the top side of the middle chassis assembly, disconnect the wire from the connector [CN323](#) on the main board.
  - Remove the four screws **M** attaching the main board on the middle chassis.
  - Remove the main board from the middle chassis.

#### Reference:

When attaching the main board, set the projections **e** of the middle chassis in the holes of the main board.

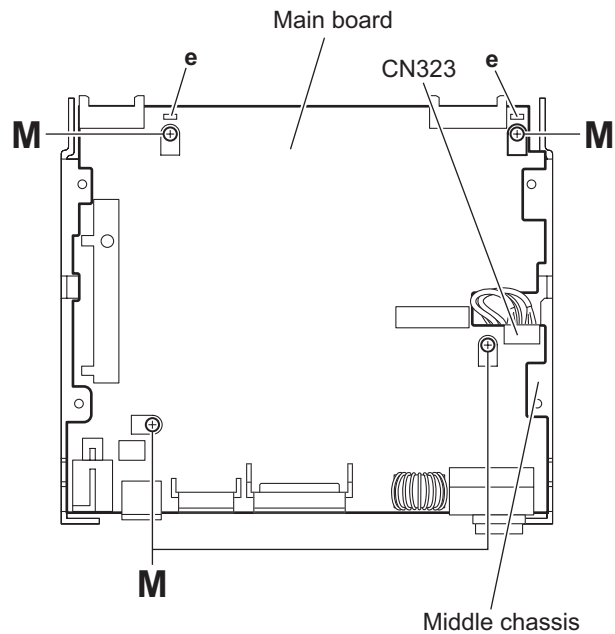

Fig.9

**3.1.10 Removing the CD mechanism control board**  
(See Fig.10)

- Remove the front panel assembly, heat sink, rear bracket, bottom chassis assembly and middle chassis assembly.
  - (1) From the inside of the top chassis assembly, disconnect the card wire from the connector [CN601](#) on the CD mechanism control board.
  - (2) Remove the five screws **N** attaching the CD mechanism control board.
  - (3) Lift the CD mechanism control board to remove the joint **f** and remove the joint **g** in the direction of the arrow.

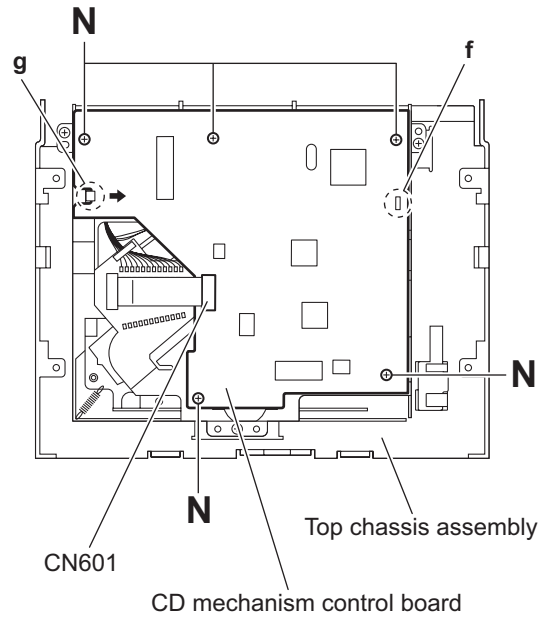

Fig.10

**3.1.11 Removing the CD mechanism assembly**  
(See Fig.11)

- Remove the front panel assembly, heat sink, rear bracket, bottom chassis assembly, middle chassis assembly and CD mechanism control board.
  - (1) From the inside of the top chassis assembly, remove the three screws **P** attaching the CD mechanism assembly.
  - (2) Take out the CD mechanism assembly from the top chassis.

**Reference:**

When attaching the CD mechanism assembly, set the projections **h** of the top chassis assembly in the holes of the CD mechanism assembly.

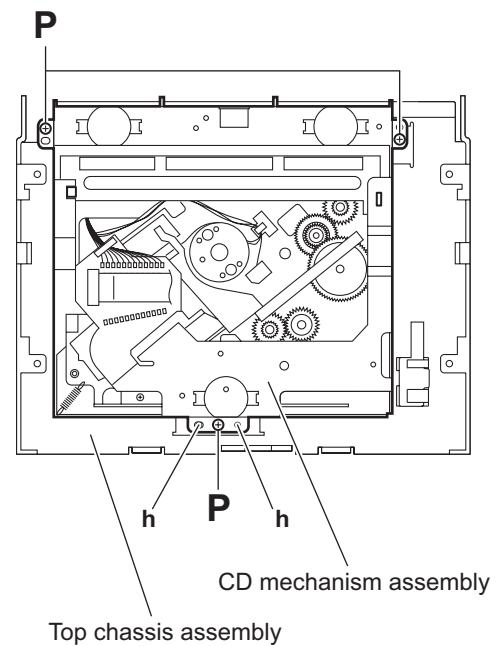

Fig.11

### 3.1.12 Removing the switch board (See Fig.12)

- Remove the front panel assembly.
  - From the inside of front panel assembly, remove the eight screws **Q** attaching the switch board.
  - Remove the volume knob from the front side of the front panel assembly in the direction of the arrow while lifting the switch board little by little.
  - Release the sections **j** while extending the lower section of the front panel assembly in the direction of the arrow and take out the switch board.

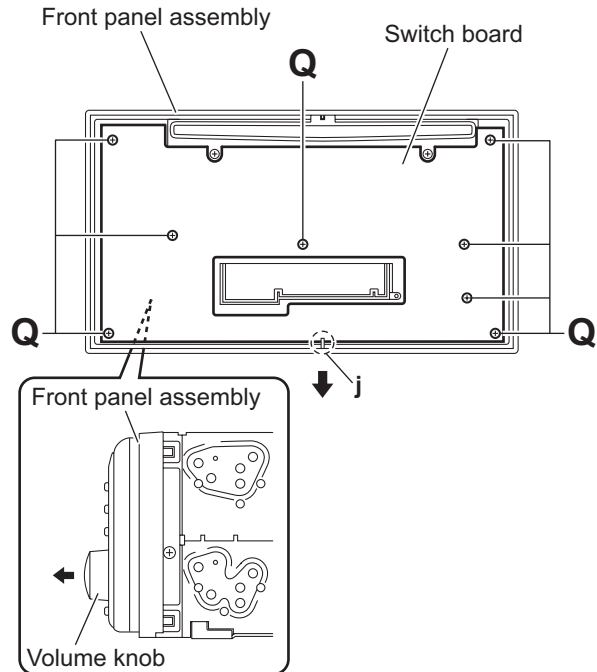

Fig.12

# SECTION 4 ADJUSTMENT

## 4.1 Adjustment method

### ■ Test instruments required for adjustment

- (1) Digital oscilloscope (100MHz)
- (2) Frequency counter meter
- (3) Electric voltmeter
- (4) Wow & flutter meter
- (5) Test tapes
  - VT724.....For DOLBY level measurement
  - VT739.....For playback frequency measurement
  - VT712.....For wow flutter & tape speed measurement
  - VT703.....For head azimuth measurement
- (6) Torque gauge.....Cassette type for CTG-N  
(Mechanism adjustment)
- (7) Laser power meter(Reader:LP800102)
- (8) Prove for MD (Reader:LP8010-02)
- (9) Pre masterd disc (TGYS-1)
- (10)Test disc (JVC:CTS1000)

### ■ Measuring conditions (Amplifier section)

- Power supply voltage..... DC14.4V (11V to 16V allowance)
- Load impedance..... 4Ω (4Ω to 8Ω allowance)
- Line out level/Impedance.....1.0V/20k load (250 nWb/m)

### ■ Standard volume position

Balance and Bass, Treble volume, Fader : Center (Indication "0")  
Loudness, Dolby NR, Sound, Cruise : Off  
Volume position is about 2V at speaker output with following conditions, Playback the test tape VT721.

AM mode	999kHz/62dB, INT/400Hz, 30% modulation signal on receiving.
FM mono mode	97.9MHz/66dB, INT/400Hz, 22.5kHz deviation pilot off mono
FM stereo mode	1kHz, 67.5kHz dev. pilot 7.5kHz dev.
Output level	0dB (1μV,50Ω/open terminal)

### ■ Information for using a car audio service jig

- (1) We're advancing efforts to make our extension cords common for all car audio products.  
Please use this type of extension cord as follows.
- (2) As a U-shape type top cover is employed, this type of extension cord is needed to check operation of the mechanism assembly after disassembly.
- (3) Extension cord : EXTSH002-22P ( 22 pin extension cord ) For connection between the mechanism assembly and main board.  
EXTXC004-20P ( 20 pin extension cord ) For connection between the front panel assembly and main board.  
EXTXC004-16P ( 16 pin extension cord ) For connection between the front panel assembly and main board.  
EXTXC004-16P ( 16 pin extension cord ) For connection between the front panel assembly and cassette mechanism assembly.
- (4) Check for mechanism driving section such as motor ,etc.

### ■ Disassembly method

- (1) Remove the front panel assembly.
- (2) Remove the heat sink.
- (3) Remove the rear bracket.
- (4) Remove the bottom chassis assembly and middle chassis assembly.
- (5) Remove the main board.
- (6) Remove the CD mechanism assembly.
- (7) Reattach the heat sink with two screws to the main board. (Refer to Disassembly method.)
- (8) Connect the main board, front panel assembly, bottom chassis assembly and CD mechanism assembly with the extension cords.

### CAUTION :

**Be sure to attach a heat sink on the power amplifier IC of a main board when supplying the power.  
If voltage is applied without attaching the heat sink, the power amplifier IC will be destroyed by heat.**

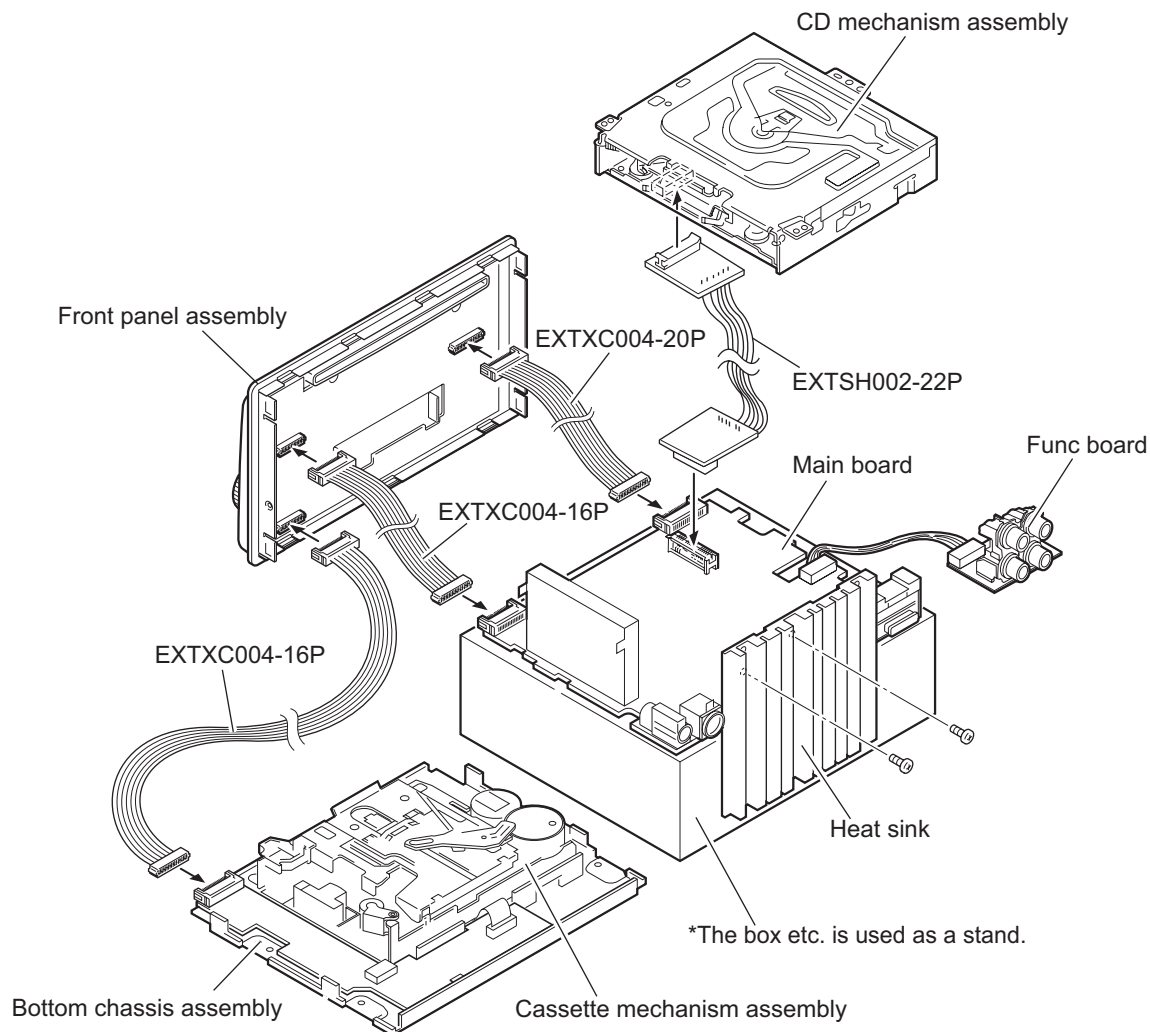

## 4.2 Service mode

Set up

Press POWER ON [SEL] → [POWER] → [CD EJECT] together more than 2 sec.

UP,DW button to select

SEL button to determination

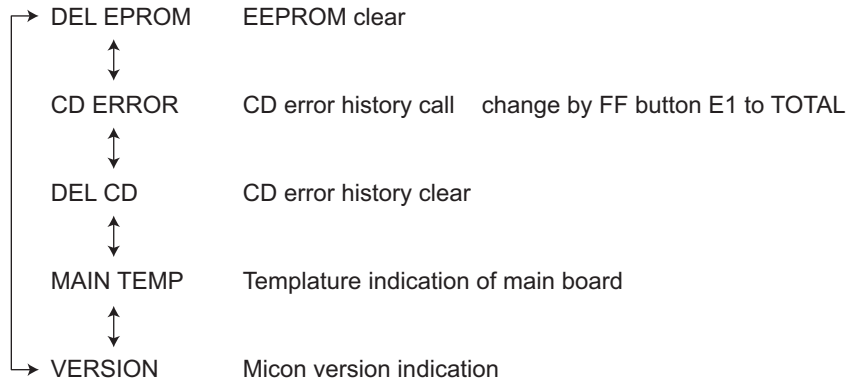

For next operation, service mode is stop automatically.

1. No input signal (key operation) more than 5 sec.
2. press other key without SEL,UP,DOWN.
3. ACC to OFF.

# SECTION 5 TROUBLESHOOTING

## 5.1 Feed section

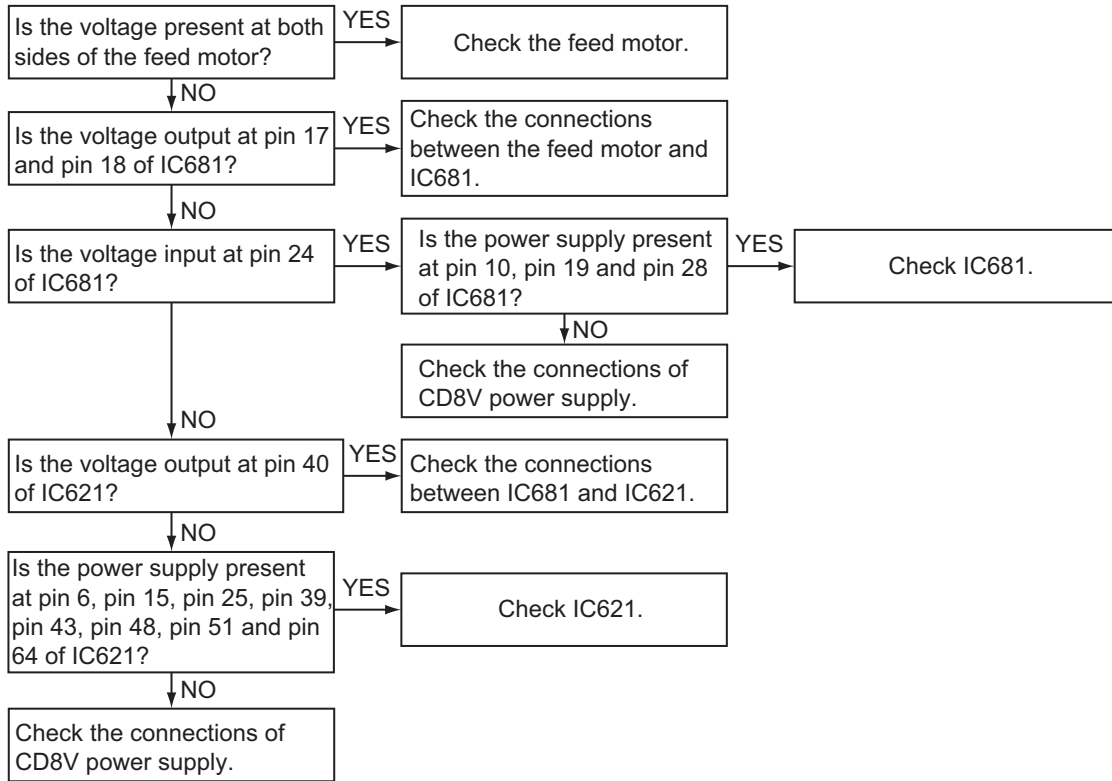

## 5.2 Focus section

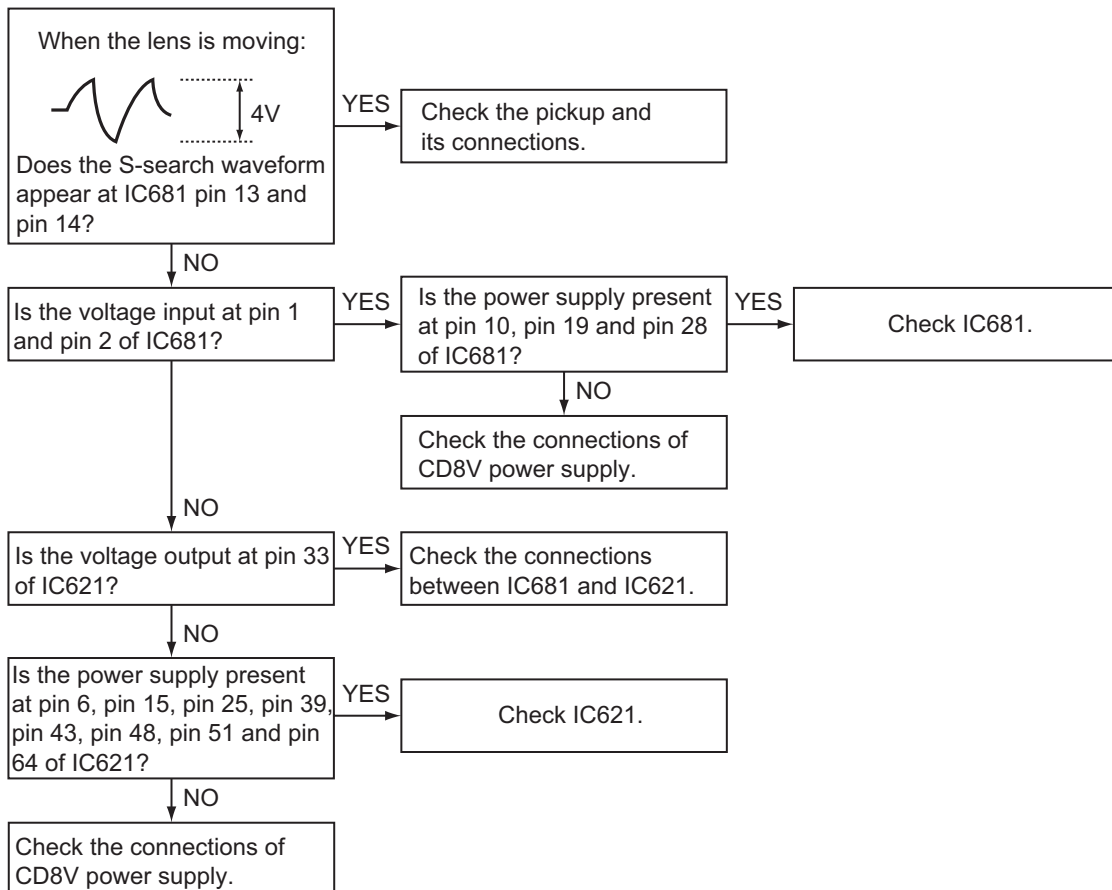



### 5.3 Spindle section

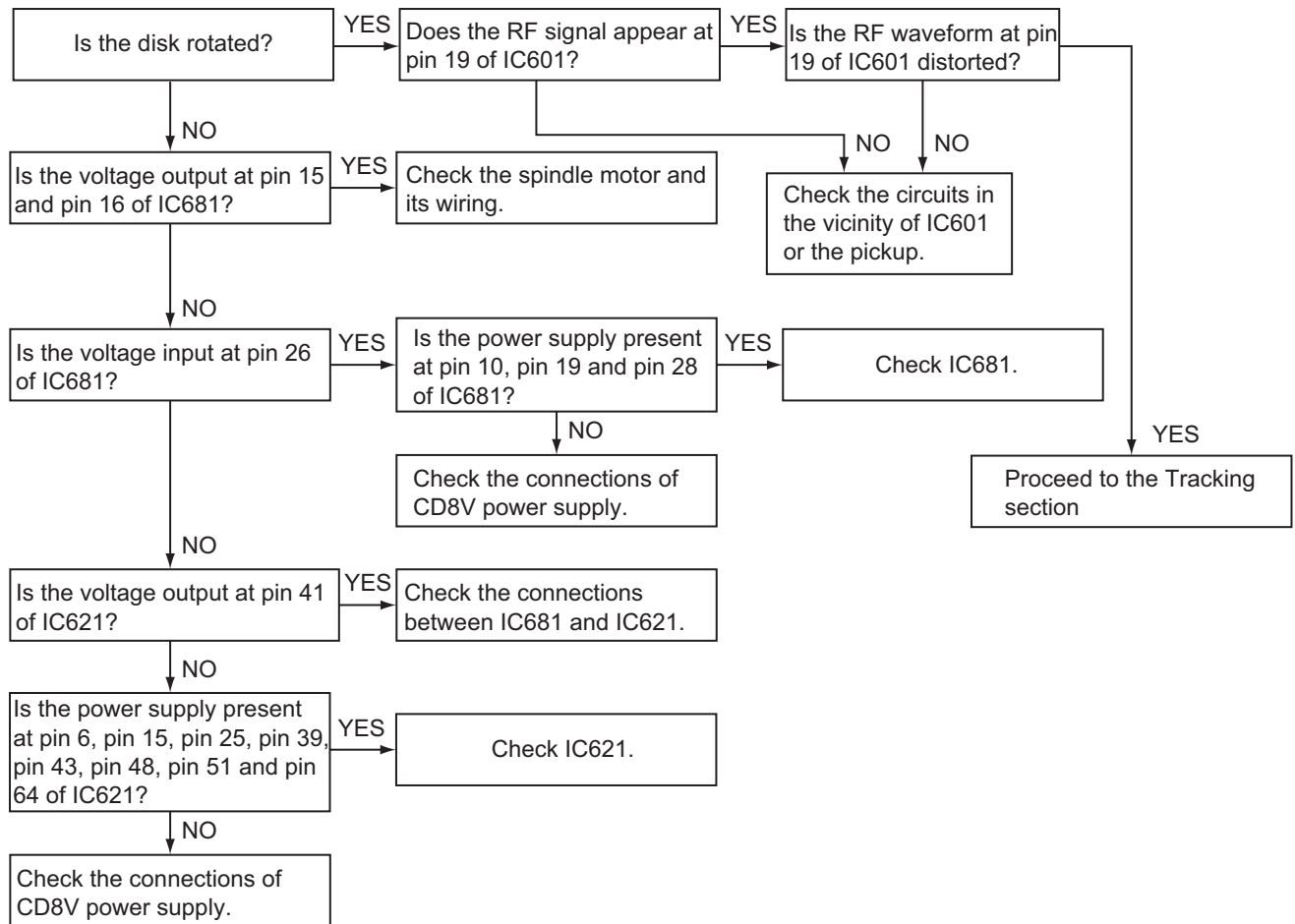

### 5.4 Tracking section

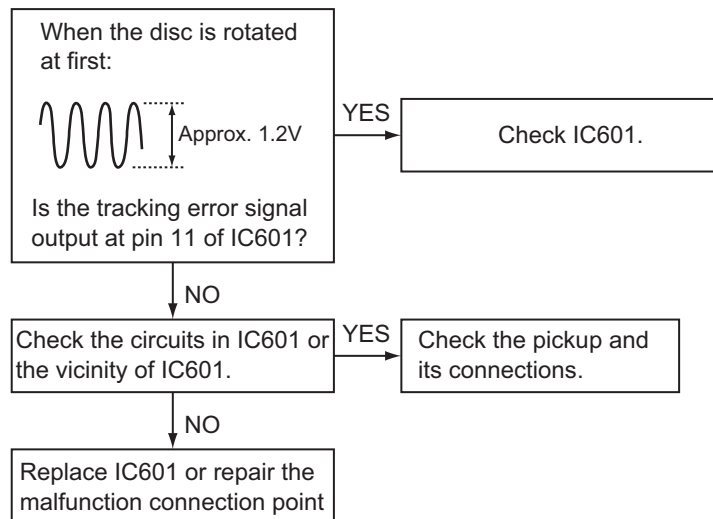

## 5.5 Signal processing section

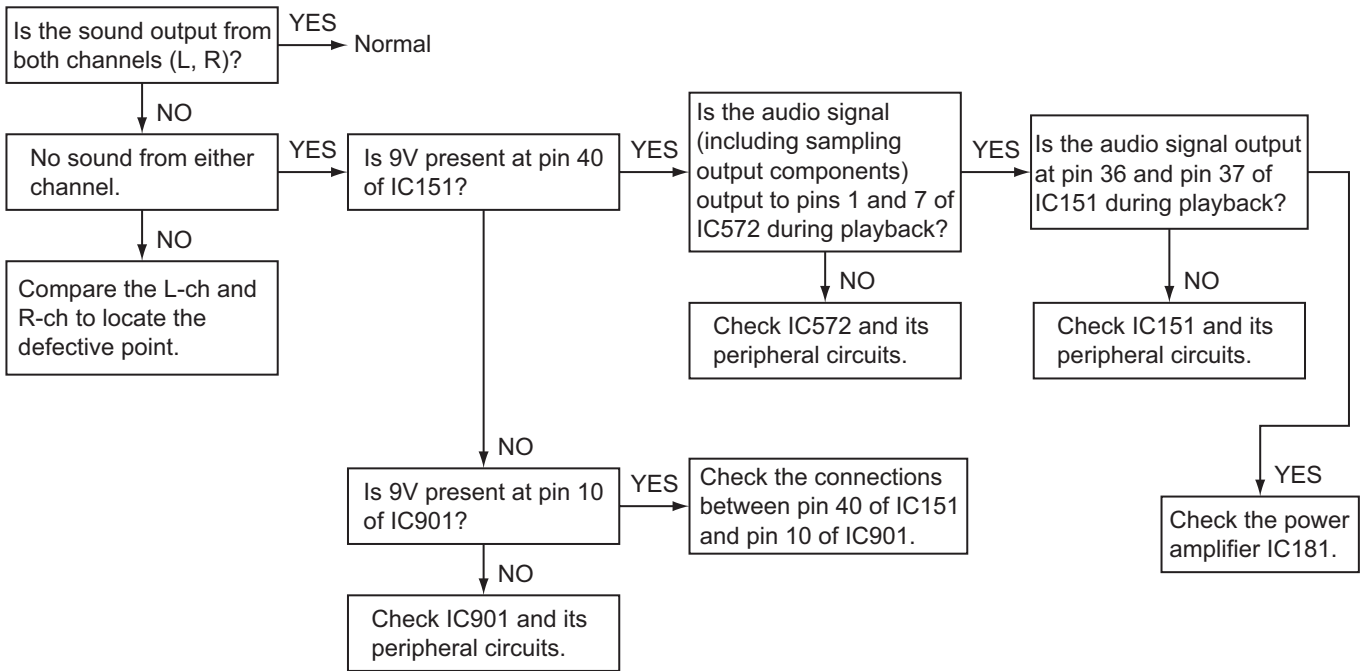

## 5.6 Maintenance of laser pickup

### (1) Cleaning the pick up lens

Before you replace the pick up, please try to clean the lens with a alcohol soaked cotton swab.

### (2) Life of the laser diode

When the life of the laser diode has expired, the following symptoms will appear.

- The level of RF output (EFM output: amplitude of eye pattern) will be low.

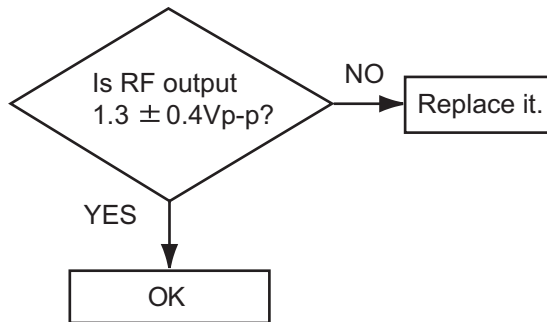

### (3) Semi-fixed resistor on the APC PC board

The semi-fixed resistor on the APC printed circuit board which is attached to the pickup is used to adjust the laser power. Since this adjustment should be performed to match the characteristics of the whole optical block, do not touch the semi-fixed resistor.

If the laser power is lower than the specified value, the laser diode is almost worn out, and the laser pickup should be replaced. If the semi-fixed resistor is adjusted while the pickup is functioning normally, the laser pickup may be damaged due to excessive current.

## 5.7 Replacement of laser pickup

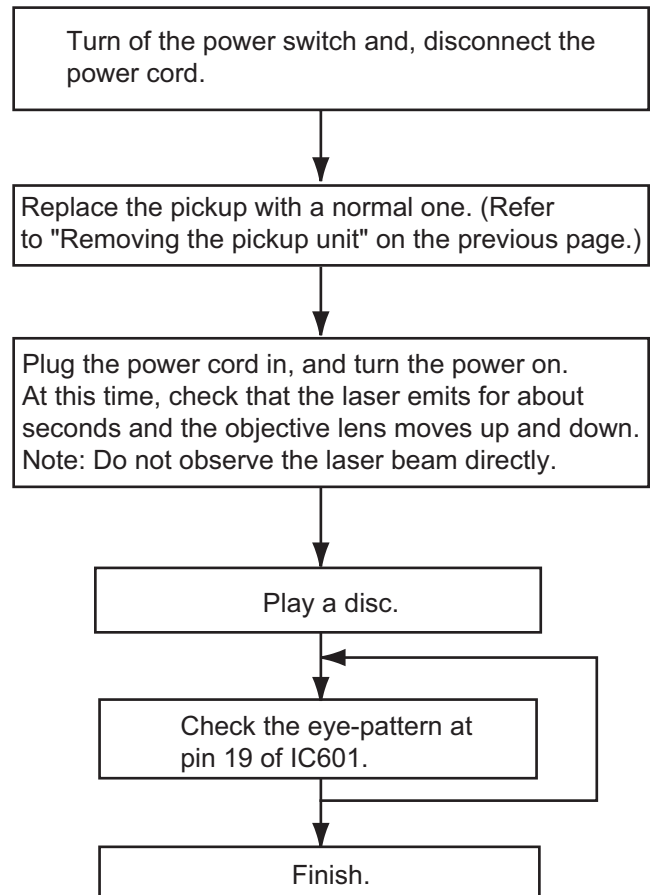

5.8 16 PIN CORD DIAGRAM

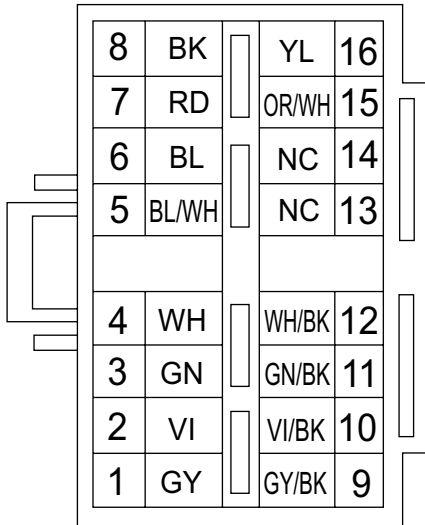

BK	Black	GN	Green
RD	Red	VI	Violet
BL	Blue	GY	Gray
WH	White	YL	Yellow
		OR	Orange

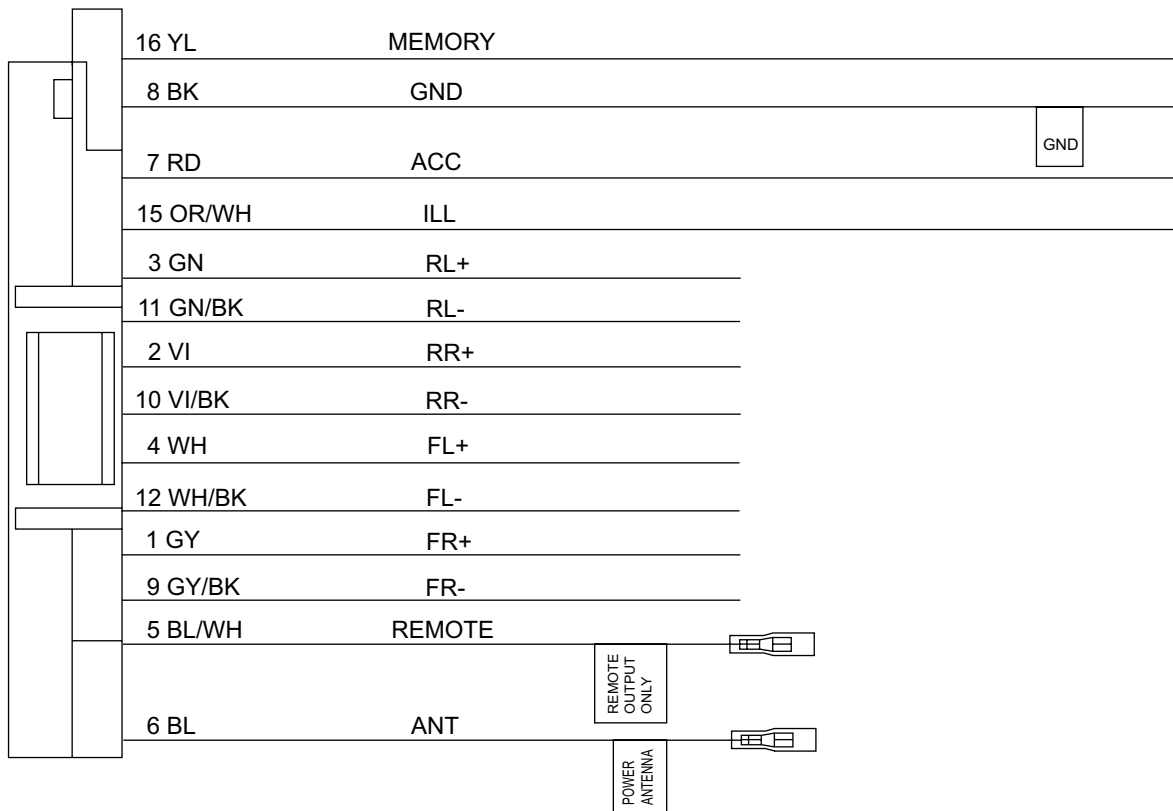

RR	Rear Right	ANT	Auto Antenna
FR	Front Right	ACC	ACC Line
FL	Front Left	ILL	Illuminations Control
RL	Rear Left	GND	Ground
REMOTE	Remote out	MEMORY	Memory Backup Battery+





**JVC**

Victor Company of Japan, Limited  
Mobile Entertainment Business Group Mobile Entertainment Category 10-1,1chome,Ohwatari-machi,Maebashi-city,371-8543,Japan

(No.MA235)

# JVC



## CD/CASSETTE RECEIVER

## KW-XC410/KW-XC400

ENGLISH

## RECEPTOR CON CD/CASSETTE KW-XC410/KW-XC400

ESPAÑOL

## RECEPTEUR CD/CASSETTE

## KW-XC410/KW-XC400

FRANÇAIS

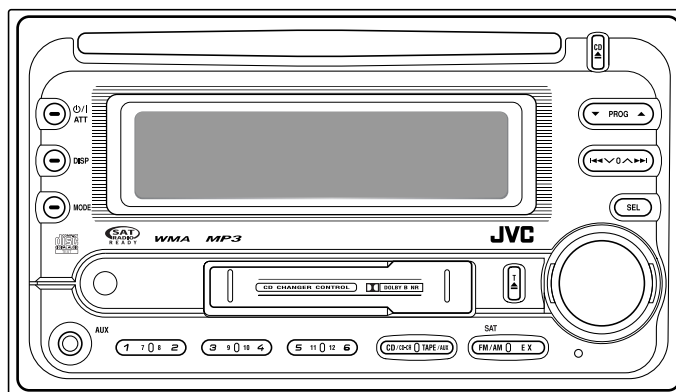
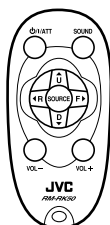

For canceling the display demonstration, see page 8.

Para cancelar la demostración en pantalla, consulte la página 8.

Pour annuler la démonstration des affichages, référez-vous à la page 8.

For installation and connections, refer to the separate manual.

Para la instalación y las conexiones, refiérase al manual separado.

Pour l'installation et les raccordements, se référer au manuel séparé.

### For customer Use:

Enter below the Model No. and Serial No. which are located on the top or bottom of the cabinet. Retain this information for future reference.

Model No. \_\_\_\_\_

Serial No. \_\_\_\_\_

# INSTRUCTIONS

## MANUAL DE INSTRUCCIONES

## MANUEL D'INSTRUCTIONS

GET0320-001B

[J]

Thank you for purchasing a JVC product.

Please read all instructions carefully before operation, to ensure your complete understanding and to obtain the best possible performance from the unit.

### **INFORMATION (For U.S.A.)**

This equipment has been tested and found to comply with the limits for a Class B digital device, pursuant to Part 15 of the FCC Rules. These limits are designed to provide reasonable protection against harmful interference in a residential installation. This equipment generates, uses, and can radiate radio frequency energy and, if not installed and used in accordance with the instructions, may cause harmful interference to radio communications. However, there is no guarantee that interference will not occur in a particular installation. If this equipment does cause harmful interference to radio or television reception, which can be determined by turning the equipment off and on, the user is encouraged to try to correct the interference by one or more of the following measures:

- Reorient or relocate the receiving antenna.
- Increase the separation between the equipment and receiver.
- Connect the equipment into an outlet on a circuit different from that to which the receiver is connected.
- Consult the dealer or an experienced radio/TV technician for help.

### **IMPORTANT FOR LASER PRODUCTS**

1. CLASS 1 LASER PRODUCT
2. **CAUTION:** Do not open the top cover. There are no user serviceable parts inside the unit; leave all servicing to qualified service personnel.
3. **CAUTION:** Visible and invisible laser radiation when open and interlock failed or defeated. Avoid direct exposure to beam.

#### **Warning:**

If you need to operate the unit while driving, be sure to look ahead carefully or you may be involved in a traffic accident.

#### **Caution on volume setting:**

Discs produce very little noise compared with other sources. Lower the volume before playing a disc to avoid damaging the speakers by the sudden increase of the output level.

#### **How to reset your unit**

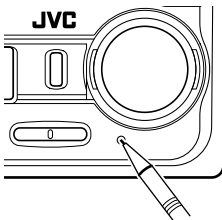

*This will reset the microcomputer. Your preset adjustments will also be erased.*

#### **How to forcibly eject a disc**

If a disc cannot be recognized or cannot be ejected, eject the disc as follows.

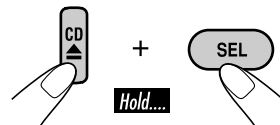

- If this does not work, reset your unit.
- Be careful not to drop the disc when it ejects.



# Contents

How to reset your unit .....	2	<b>Tape operations .....</b>	<b>17</b>
How to forcibly eject a disc .....	2	<b>Playing a tape.....</b>	<b>17</b>
How to read this manual .....	4	Finding the beginning of a tune .....	17
How to use the MODE button .....	4	Other convenient tape functions .....	17
<b>Control panel —</b>		<b>Sound adjustments .....</b>	<b>18</b>
<b>KW-XC410/KW-XC400.....</b>	<b>5</b>	<b>Selecting preset sound modes</b>	
Parts identification .....	5	<b>(EQ: equalizer).....</b>	<b>18</b>
<b>Remote controller — RM-RK50 ...</b>	<b>6</b>	Adjusting the sound .....	18
Main elements and features .....	6	Storing your own sound adjustments.....	19
<b>Getting started.....</b>	<b>7</b>	<b>General settings — PSM .....</b>	<b>20</b>
<b>Basic operations .....</b>	<b>7</b>	Basic procedure .....	20
Canceling the display demonstrations ...	8	<b>External component operations... 23</b>	
Setting the clock .....	8	<b>Playing an external component .....</b>	<b>23</b>
<b>Radio operations .....</b>	<b>9</b>	<b>Satellite radio operations .....</b>	<b>24</b>
<b>Listening to the radio.....</b>	<b>9</b>	Listening to the SIRIUS Satellite radio... 25	
Storing stations in memory .....	9	Listening to the XM Satellite radio .....	25
Listening to a preset station .....	10	Storing channels in memory .....	26
Scanning broadcast stations .....	10	Listening to a preset channel .....	26
Assigning titles to the stations .....	11	<b>Maintenance .....</b>	<b>27</b>
<b>Disc operations .....</b>	<b>12</b>	Handling discs .....	27
<b>Playing a disc in the unit .....</b>	<b>12</b>	Handling cassettes .....	27
<b>Playing discs in the CD changer .....</b>	<b>13</b>	<b>More about this unit.....</b>	<b>28</b>
Other main functions .....	15	<b>Troubleshooting .....</b>	<b>31</b>
Changing the display information .....	15	<b>Specifications .....</b>	<b>33</b>
Selecting the playback modes.....	16		

## For safety....

- Do not raise the volume level too much, as this will block outside sounds, making driving dangerous.
- Stop the car before performing any complicated operations.



## Temperature inside the car....

If you have parked the car for a long time in hot or cold weather, wait until the temperature in the car becomes normal before operating the unit.

## How to read this manual

The following methods are used to make the explanations simple and easy-to-understand:

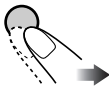
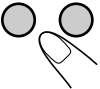
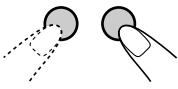
- Some related tips and notes are explained in “More about this unit” (see pages 28 – 30).
- Button operations are mainly explained with the illustrations as follows:

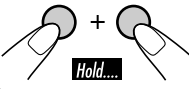
	Press briefly.
	Press repeatedly.
	Press either one.
	
	Press and hold until your desired response begins.
	Press and hold both buttons at the same time.

The following marks are used to indicate...



: Built-in CD player operations.



: External CD changer operations.

This unit is equipped with the steering wheel remote control function.

- See the Installation/Connection Manual (separate volume) for connection.

## How to use the MODE button

Press MODE repeatedly to select the different functions available during play.

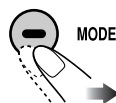

Time countdown indicator

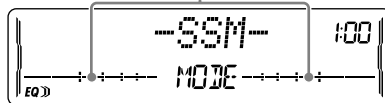

Ex.: When “SSM” is selected

### While listening to the radio:

- You cannot select “SSM” or “SCAN” if you are listening to the station stored in the EX (extra) button, see page 10 for details.

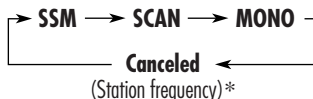

### While listening to a disc:



### While listening to a tape:



### While adjusting the sound mode:

- Pressing MODE allows you to store the adjusted sound mode into memory. (See page 19 for details.)

\* Depending on the level meter setting. (See page 20 for details.)

## Parts identification

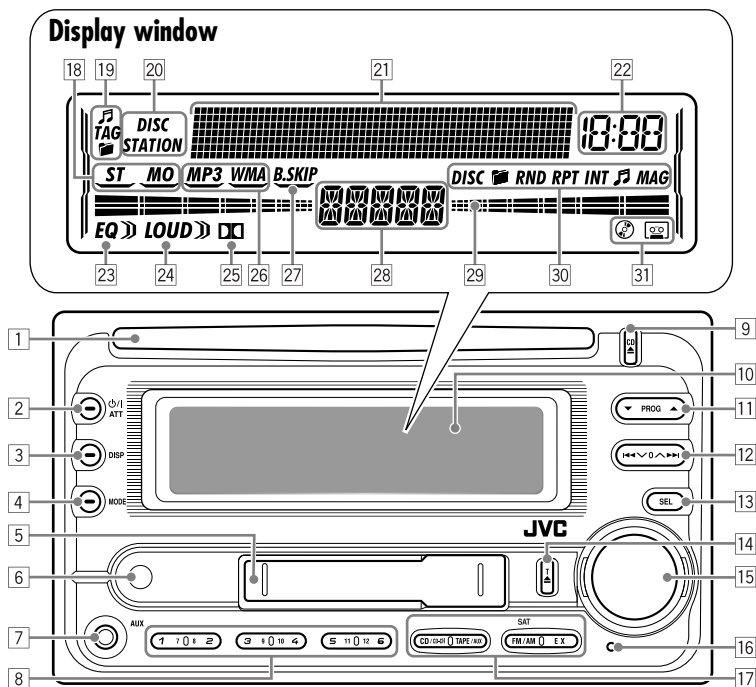

- 1 Loading slot
- 2  $\phi$ /I ATT (standby/on attenuator) button
- 3 DISP (display) button
- 4 MODE button
- 5 Cassette compartment
- 6 Remote sensor
  - **DO NOT** expose the remote sensor to strong light (direct sunlight or artificial lighting).
- 7 AUX (auxiliary) input jack
- 8 Number buttons
- 9 CD  $\blacktriangle$  (CD eject) button
- 10 Display window
- 11  $\blacktriangle$  (up) /  $\blacktriangledown$  (down) buttons  
PROG (program)  $\blacktriangle$  /  $\blacktriangledown$  buttons
- 12  $\blacktriangle\blacktriangle\blacktriangle$  /  $\blacktriangleright$  /  $\blacktriangle$  /  $\blacktriangle\blacktriangle\blacktriangle$  buttons
- 13 SEL (select) button
- 14 T  $\blacktriangle$  (tape eject) button
- 15 Control dial
- 16 Reset button
- 17 Source buttons—CD/CD-CH, TAPE/AUX, FM/AM SAT (satellite), EX (extra)

### Display window

- 18 Tuner reception indicators—ST (stereo), MO (monaural)
- 19 Disc information indicators— $\text{♪}$  (track/file), TAG (ID3 Tag),  $\text{📁}$  (folder)
- 20 Text name indicators—DISC, STATION
- 21 Main display, level meter
- 22 Clock indicator
- 23 EQ (equalizer) indicator
- 24 LOUD (loudness) indicator
- 25  $\text{DB NR}$  (Dolby B NR) indicator
- 26 Playback disc indicators—MP3, WMA
- 27 B.SKIP (blank skip) indicator
- 28 Source display
- 29 Level meter, volume meter, time countdown indicator
- 30 Playback mode indicators—DISC,  $\text{📁}$  (folder), RND (random), RPT (repeat), INT (intro),  $\text{♪}$  (track/file), MAG (magazine)
- 31 Loaded source indicators— $\text{📀}$  (disc),  $\text{📼}$  (tape)

# Remote controller — RM-RK50

## Installing the lithium coin battery (CR2025)

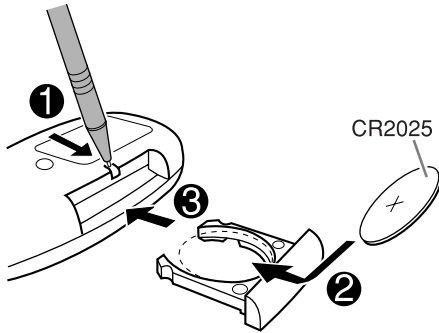

- When operating, aim the remote controller directly at the remote sensor on the unit. Make sure there is no obstacle in between.

### Warning:

- Do not install any battery other than CR2025 or its equivalent; otherwise, it may explode.
- Store the battery in a place where children cannot reach to avoid risk of accident.
- To prevent the battery from over-heating, cracking, or starting a fire:
  - Do not recharge, short, disassemble, heat the battery, or dispose of it in a fire.
  - Do not leave the battery with other metallic materials.
  - Do not poke the battery with tweezers or similar tools.
  - Wrap the battery with tape and insulate when throwing away or saving it.

### Caution:

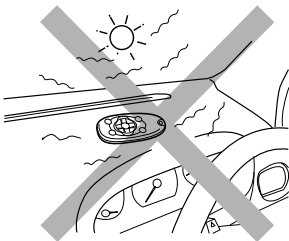

## Main elements and features

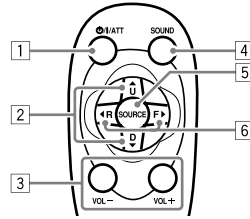

- 1** **⏻/I/ATT** (standby/on/attenuator) button
  - Turns the power on if pressed briefly or attenuates the sound when the power is on.
  - Turns the power off if pressed and held.
- 2** **▲ U** (up) / **D** (down) **▼** buttons
  - Changes the FM/AM bands with **▲ U** only.
  - Changes the preset stations with **D ▼** only.
  - Changes the folder of the MP3/WMA discs.
  - Changes the tape directions with **▲ U** only.
  - While playing an MP3 disc on an MP3-compatible CD changer:
    - Changes the disc if pressed briefly.
    - Changes the folder if pressed and held.
  - While listening to the satellite (SIRIUS or XM) radio:
    - Changes the categories.
- 3** **VOL - / VOL +** buttons
  - Adjusts the volume level.
- 4** **SOUND** button
  - Selects the sound mode (EQ: equalizer).
- 5** **SOURCE** button
  - Selects the source.
- 6** **◀ R** (reverse) / **F** (forward) **▶** buttons
  - Searches for stations if pressed briefly.
  - Fast-forwards or reverses the track if pressed and held.
  - Changes the tracks of the disc if pressed briefly.
  - Fast-forwards or reverses the tape if pressed and held.\*
  - Finds the beginning of a tune (MMS) while listening to a tape if pressed briefly.\*
  - While listening to the satellite radio:
    - Changes the channels if pressed briefly.
    - Changes the channels rapidly if pressed and held.

\* To release these operations, press **▲ U**. Playback resumes.

# Getting started

## Basic operations

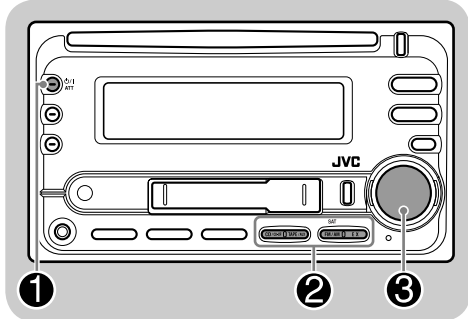

### For your favorite station



- Stored your favorite station, see page 10 for details.

### For CD/CD-CH



### For TAPE/AUX

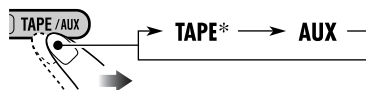

- Select “CD-CH” when using an Apple iPod® or a JVC D. player (see page 23).

iPod is a trademark of Apple Computer, Inc., registered in the U.S. and other countries.

\* You cannot select these sources if they are not ready or not connected.

## 1 Turn on the power.



## 2 For FM/AM tuner



### For SIRIUS Satellite radio\*

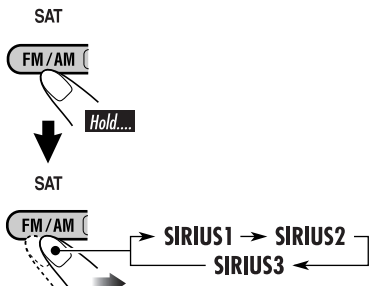

### For XM Satellite radio\*

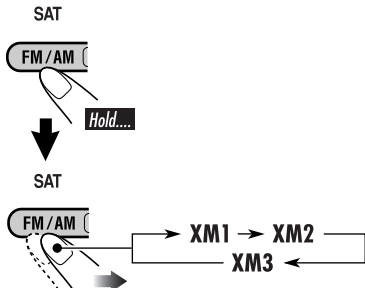

## 3 Adjust the volume.

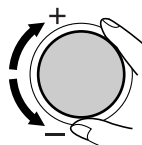

Volume level appears.

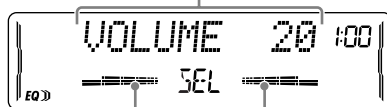

Volume level indicator

## 4 Adjust the sound as you want. (See pages 18 and 19.)

### To drop the volume in a moment (ATT)



To restore the sound, press it again.

### To turn off the power



## Canceling the display demonstrations

If no operations are done for about 20 seconds, display demonstration starts.

[Initial: DEMO ON]—see page 20.

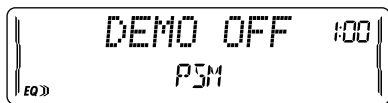
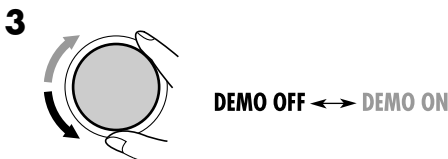
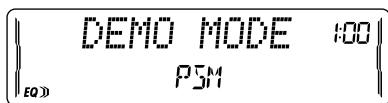
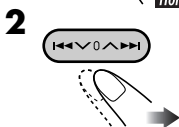

### 4 Finish the procedure.



### To activate the display demonstration

In step 3 above...



## Setting the clock



- 2 Set the hour and minute.
- 1 Select “CLOCK HOUR,” then adjust the hour.
  - 2 Select “CLOCK MIN,” (minute) then adjust the minute.

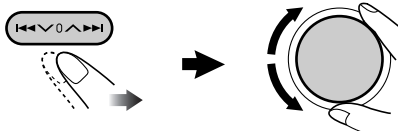

### 3 Finish the procedure.



# Radio operations

## Listening to the radio

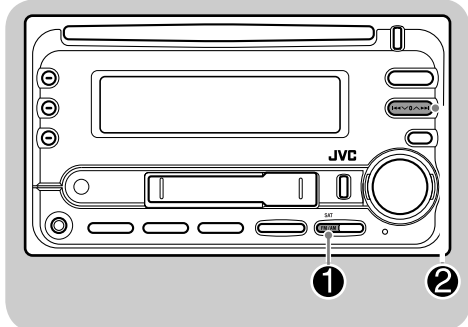

**1** SAT

Lights up when receiving an FM stereo broadcast with sufficient signal strength.

Selected band appears.

**2** Start searching for a station.

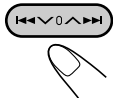

When a station is received, searching stops.

To stop searching, press the same button again.

### To tune in to a station manually

In step 2 above...

**1**

Hold...

**2** Select the desired station frequencies.

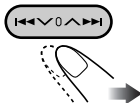

### When an FM stereo broadcast is hard to receive

**1**

**2**

Lights up when monaural mode is activated.



Reception improves, but stereo effect will be lost.

To restore the stereo effect, repeat the same procedure. Then, in step 2, select “MONO OFF.”

## Storing stations in memory

You can preset six stations for each band.

### FM station automatic presetting—SSM (Strong-station Sequential Memory)

**1** Select the FM band (FM1 – FM3) you want to store into.

SAT

To be continued....

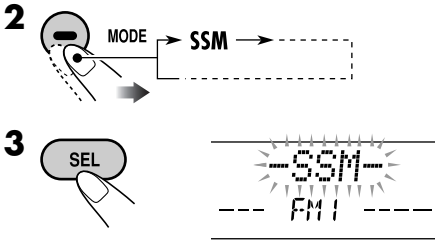

“SSM” flashes, then disappears when automatic presetting is over.

Local FM stations with the strongest signals are searched and stored automatically in the FM band.

### Manual presetting

Ex.: Storing FM station of 92.5 MHz into the preset number 4 of the FM1 band.

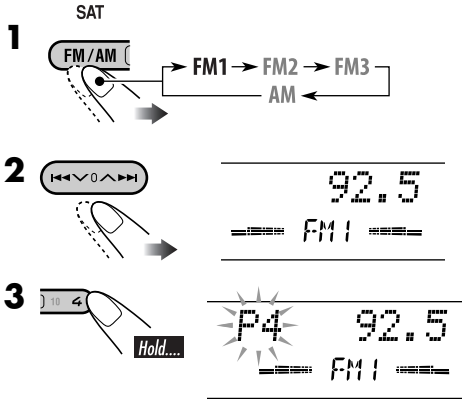

Preset number flashes for a while.

### Storing your favorite station into the EX (extra) button

Ex.: Storing your favorite FM station of 92.5 MHz into the EX button

While listening to an FM station, tune in to your favorite station, then....



### Listening to a preset station

- 1 Press the MODE button to select the FM/AM band. The display shows FM1, FM2, FM3, and AM.
- 2 Select the preset station (1 – 6) you want.



or



### To tune in to your favorite station (EX)

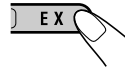

If you press the button again, the previous source will be played back again.

### Scanning broadcast stations

- 1 Press the MODE button to select the SCAN mode.
- 2 Start scanning. The display shows SCAN 92.5 and FM1.

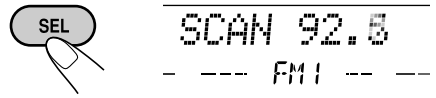

Each time a broadcast is tuned in, scanning stops for about 5 seconds (tuned frequency appears on the display), and you can check what program is now being broadcast.

- 3 Start listening to the program.

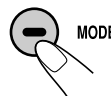



## Assigning titles to the stations

You can assign titles to 30 station frequencies (including both FM and AM). Each station name can be assigned up to 10 characters. However, you cannot assign title to the station frequency stored in the EX button.

- 1 Tune in to the station you would like to assign a title to.
- 2 Enter the assigning mode.

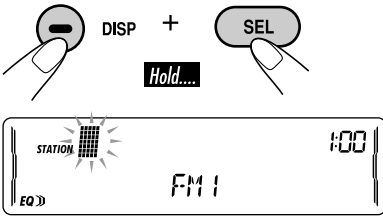

### 3 Assign a title.

- 1 Select a character set.

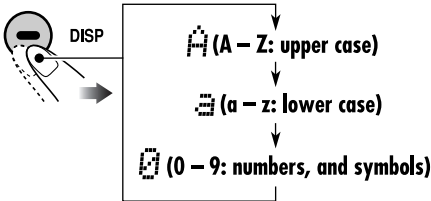

- 2 Select a character.

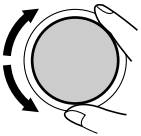

- 3 Move to the next (or previous) character position.

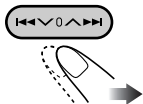

- 4 Repeat steps 1 to 3 until you finish entering the title.

- 4 Finish the procedure.



### To erase the entire title

In step 3 on the left...

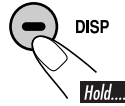

### To change the information shown on the display

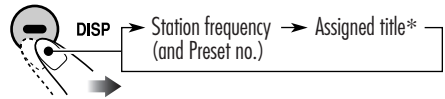

\* If no title is assigned, "NO NAME" appears for a while.

### Available characters

Upper case

A	B	C	D	E	F	G	H	I	J	K	L	M	N
O	P	Q	R	S	T	U	V	W	X	Y	Z	space	

Lower case

a	b	c	d	e	f	g	h	i	j	k	l	m	n
o	p	q	r	s	t	u	v	w	x	y	z	space	

Numbers and symbols

0	1	2	3	4	5	6	7	8	9	!	"	#	\$
%	&	'	(	)	*	+	,	-	.	/	:	;	<
=	>	?	@	_	^	space							

# Disc operations

## Playing a disc in the unit

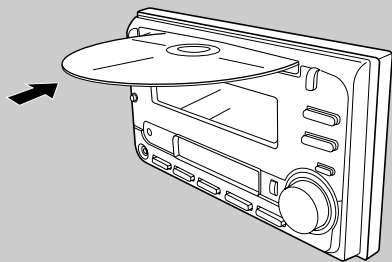

All tracks will be played repeatedly until you change the source or eject the disc.

- When inserting an MP3 or a WMA disc:

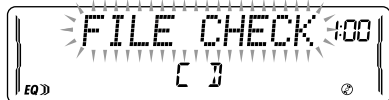

Total folder number      Total file number

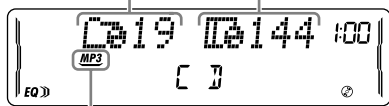

\*1

**Disc information appears automatically (see page 15).**

Current track number\*2      Elapsed playing time\*2

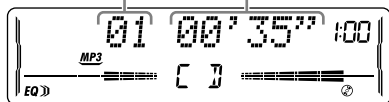

- When inserting an audio CD or a CD Text disc:

Total track number of the inserted disc      Total playing time of the inserted disc

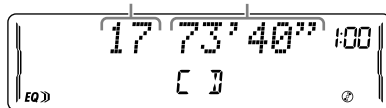

**CD Text: Disc title/performer →  
Track title appears automatically (see page 15).**

Current track number\*2      Elapsed playing time\*2

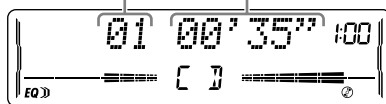

### To stop play and eject the disc



The source changes to the last selected source.

\*1 Either the MP3 or WMA indicator lights up depending on the detected file.

\*2 Depending on the level meter setting. (See page 20 for details.)

## Playing discs in the CD changer

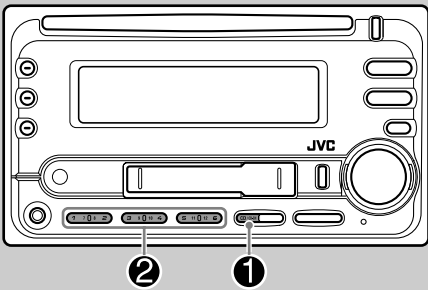

### About the CD changer

It is recommended to use a JVC MP3-compatible CD changer with your unit.

- You can also connect other CH-X series CD changers (except CH-X99 and CH-X100). However, they are not compatible with MP3 discs, so you cannot play back MP3 discs.
- You cannot play any WMA disc in the CD changer.
- You cannot use the KD-MK series CD changers with this unit.
- Disc text information recorded in the CD Text can be displayed when a JVC CD Text compatible CD changer is connected.

For connection, see Installation/Connection Manual (separate volume).

- All disc in the magazine will be played repeatedly until you change the source.
- Ejecting the magazine will also stop playing.

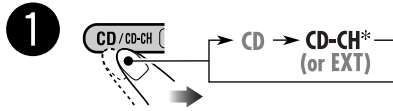

\* If you have changed "EXT INPUT" setting to "EXT INPUT" (see page 22), you cannot select the CD changer.

### 2 Select a disc.

For disc number from 01 – 06:

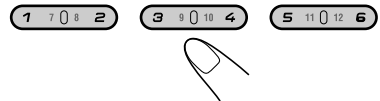

For disc number from 07 – 12:

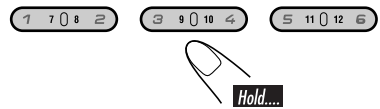

Selected disc number

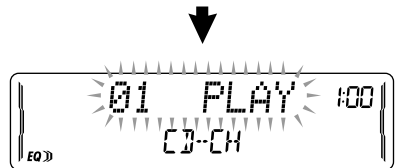
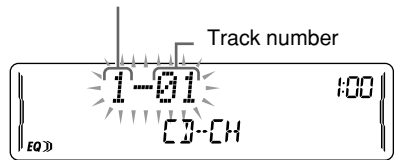

- When the current disc is an MP3 disc:

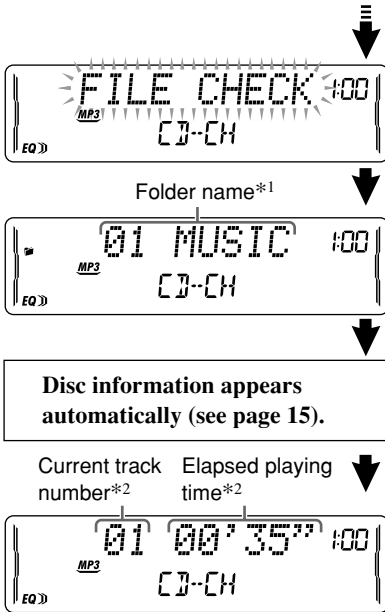

- When the current disc is an audio CD or a CD Text disc:

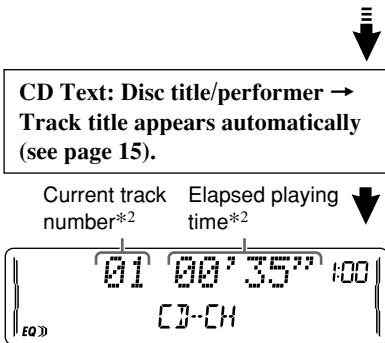

\*1 "ROOT" appears if no folder is included in the disc.

\*2 Depending on the level meter setting. (See page 20 for details.)

### To fast-forward or reverse the track

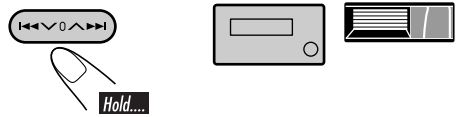

### To go to the next or previous tracks

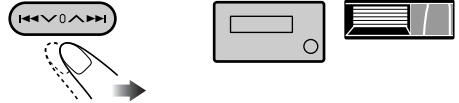

### To go to the next or previous folders for MP3 and WMA discs

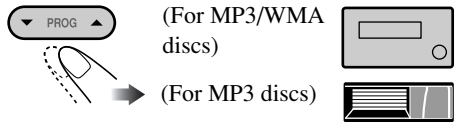

### To locate a particular track (for CD) or folder (for MP3 or WMA discs) directly

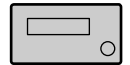

To select a number from 01 – 06:



To select a number from 07 – 12:

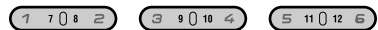

- To use folder search on MP3/WMA discs, it is required that folders are assigned with 2-digit numbers at the beginning of their folder names—01, 02, 03, and so on.

To select a particular track in a folder (for MP3 or WMA disc):

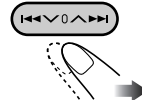

## Other main functions

### ■ Skipping a track quickly during play



Only possible on JVC  
MP3-compatible CD changer

- For MP3 or WMA disc, you can skip a track within the same folder.

Ex.: To select track 32 while playing track 6

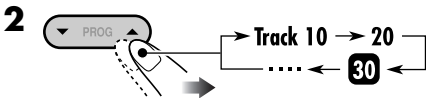
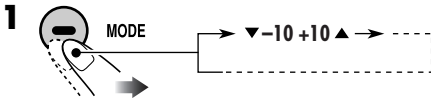

First time you press ▲ / ▼ button, the track skips to the nearest higher or lower track with a track number of multiple ten (ex. 10th, 20th, 30th).

Then each time you press the button, you can skip 10 tracks.

- After the last track, the first track will be selected and vice versa.

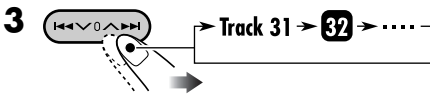

### ■ Prohibiting disc ejection



You can lock a disc in the loading slot.

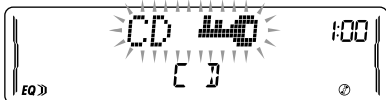

To cancel the prohibition, repeat the same procedure.

## Changing the display information

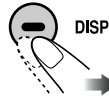

### ■ While playing an audio CD or a CD Text



### ■ While playing an MP3 or a WMA disc

- When “TAG DISP” is set to “TAG ON” (see page 22)

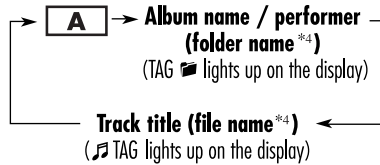

- When “TAG DISP” is set to “TAG OFF”

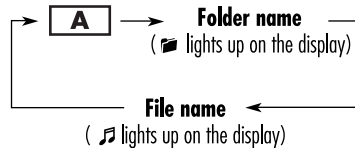

**A** : Current track/file number and Elapsed playing time

\*3 If the current disc is an audio CD, “NO NAME” appears.

\*4 If an MP3/WMA file does not have ID3 tags, folder name and file name appear. In this case, the TAG indicator will not light up.

## Selecting the playback modes

You can use only one of the following playback modes at a time.

Select your desired playback mode.



### Repeat play

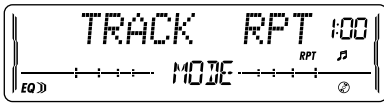

Ex.: When "TRACK RPT" is selected

### Mode

### Plays repeatedly

- TRACK RPT** : The current track.
  - RPT and light up.
- FOLDER RPT**\*1 : All tracks of the current folder.
  - and RPT light up.
- DISC RPT**\*2 : All tracks of the current disc.
  - DISC and RPT light up.
- REPEAT OFF** : Cancels.

### Random play



Ex.: When "DISC RND" is selected

### Mode

### Plays at random

- FOLDER RND**\*1 : All tracks of the current folder, then tracks of the next folder and so on.
  - and RND light up.
- DISC RND** : All tracks of the current disc.
  - DISC and RND light up.
- MAG RND**\*2 : All tracks of the inserted discs.
  - RND and MAG light up.
- RANDOM OFF** : Cancels.

### Intro scan

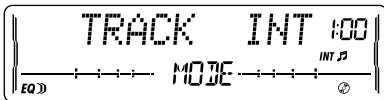

Ex.: When "TRACK INT" is selected

### Mode

### Plays the beginning 15 seconds of...

- TRACK INT** : All tracks of the current disc.
  - INT and light up.
- FOLDER INT**\*1 : The first track of every folder of the current disc.
  - and INT light up.
- DISC INT**\*2 : The first tracks of the inserted discs.
  - DISC and INT light up.
- INTRO OFF** : Cancels.

\*1 Only while playing an MP3 disc or a WMA disc.

\*2 Only while playing discs in the CD changer.

# Tape operations

## Playing a tape

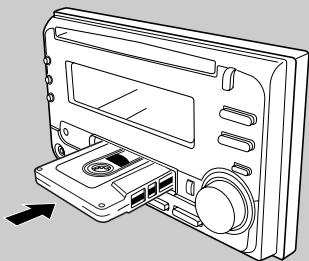

Playback starts automatically. When one side of the tape reaches its end during play, the other side of the tape automatically starts playing. (Auto Reverse)

## To change the playback direction



## To stop play and eject the cassette



The source changes to the last selected source.

## To fast-forward or rewind a tape

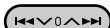

Hold....

When the tape reaches its end while fast-forwarding, the tape direction will change automatically.

To stop fast-forwarding or rewinding, press the PROG button.

## Prohibiting tape ejection

You can lock a tape in the loading slot.

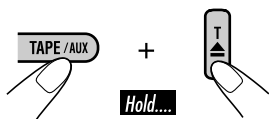

Hold....

To cancel the prohibition, repeat the same procedure.

## Finding the beginning of a tune

Multi Music Scan (MMS) allows you to automatically start playback from the beginning of a specified tune.

Specify the tune you want to locate (how many tunes ahead of or before the current tune)

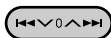

When the beginning of the specified tune is located, playback starts automatically.

MMS -9 <-> MMS -1\*<sup>3</sup>, MMS +1 <-> MMS +9

\*<sup>3</sup> Goes back to the beginning of the current tune.

## Other convenient tape functions

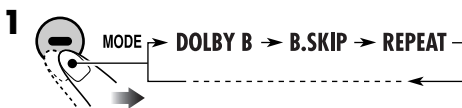

• To turn on or off Dolby B NR\*<sup>4</sup>

DOLBY ON <-> DOLBY OFF  
( lights up on the display)

• To skip blank portions on the tape

B.SKIP ON <-> B.SKIP OFF  
(B.SKIP lights up on the display)

• To play the current tune repeatedly

REPEAT ON <-> REPEAT OFF  
(RPT lights up on the display)

\*<sup>4</sup> Manufactured under license from Dolby Laboratories. "Dolby" and the double-D symbol are trademarks of Dolby Laboratories.

# Sound adjustments

## Selecting preset sound modes (EQ: equalizer)

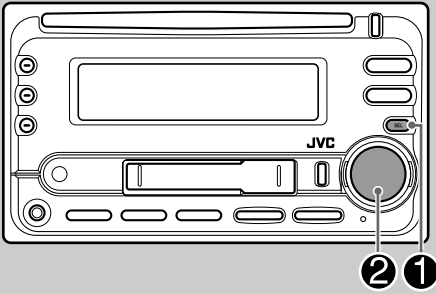

You can select a preset sound mode suitable to the music genre.

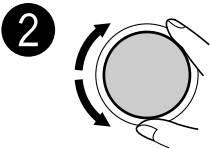
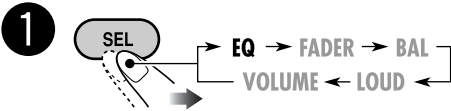

FLAT ⇄ Hard Rock ⇄ R & B ⇄  
 POP ⇄ JAZZ ⇄ DanceMusic ⇄  
 Country ⇄ Reggae ⇄ Classic ⇄  
 USER 1 ⇄ USER 2 ⇄ USER 3 ⇄  
 (back to the beginning)

### To select the sound mode directly

You can select the sound mode directly using the remote controller.

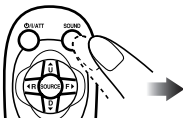

## Adjusting the sound

You can adjust the sound characteristics to your preference.

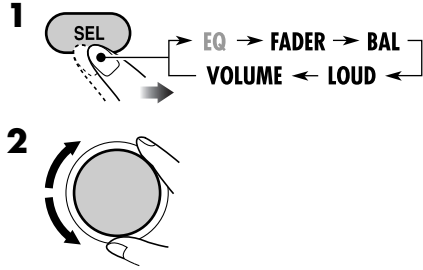

Indication	Range
<b>FADER</b> *1 Adjust the front and rear speaker balance.	R06 (Rear only) to F06 (Front only)
<b>BAL</b> (balance) Adjust the left and right speaker balance.	L06 (Left only) to R06 (Right only)
<b>LOUD</b> (loudness) Boost low and high frequencies to produce a well-balanced sound at low volume level.	LOUD ON ↓ LOUD OFF
<b>VOLUME</b> *2 Adjust the volume.	00 (min.) to 30 or 50 (max.)*3

\*1 If you are using a two-speaker system, set the fader level to "00."

\*2 Normally the control dial works as the volume control. So you do not have to select "VOLUME" to adjust the volume level.

\*3 Depending on the amplifier gain control setting. (See page 22 for details.)



## Storing your own sound adjustments

You can adjust the sound modes and store your own adjustments in memory.

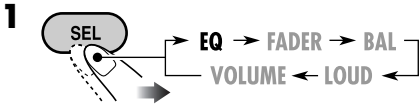

**2** Select one of the sound mode to adjust.

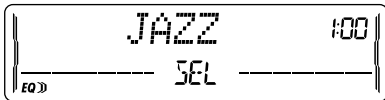
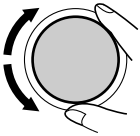

Ex.: When "JAZZ" is selected

**3** Select the sound elements to adjust while the selected sound mode is shown.

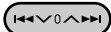

LOW LEVEL ⇄ LOW FREQ. ⇄  
 LOW WIDTH ⇄ MID LEVEL ⇄  
 MID WIDTH ⇄ HIGH LEVEL ⇄  
 HIGH FREQ. ⇄ (back to the beginning)

- **(LOW, MID, HIGH) LEVEL:**  
Adjust the enhancement level.
- **(LOW, HIGH) FREQ:**  
Select the center frequency to adjust.
- **(LOW, MID) WIDTH :**  
Select the band width level.

**4** Adjust the selected sound elements while the indication on step 3 is shown.



Indication	Preset values		
	LOW	MID	HIGH
LEVEL	-06 (min.) to +06 (max.)	-06 (min.) to +06 (max.)	-06 (min.) to +06 (max.)
FREQ	60Hz 80Hz 100Hz 120Hz	—	8kHz 10kHz 12kHz 15kHz
WIDTH	1 (min.) to 4 (max.)	1 (min.) to 2 (max.)	—

**5** Repeat steps 3 and 4 to set (or adjust) the other sound elements.

**6** Select one of the user sound modes (USER 1, USER 2, USER 3).

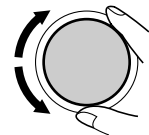
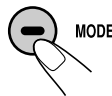

**7** Store the adjustments.

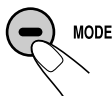

"MEMORY" appears for a while.

# General settings — PSM

## Basic procedure

You can change PSM (Preferred Setting Mode) items (except “SID”) listed in the table that follows.



**2** Select a PSM item.

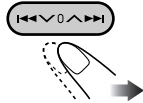

**3** Adjust the PSM item selected.

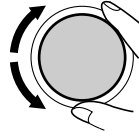

**4** Repeat steps **2** and **3** to adjust the other PSM items if necessary.

**5** Finish the procedure.



Indications	Selectable settings, [reference page]
<b>DEMO MODE</b> Display demonstration	<b>DEMO ON</b> : [Initial]; Display demonstration will be activated automatically if no operation is done for about 20 seconds, [8]. <b>DEMO OFF</b> : Cancels.
<b>CLOCK HOUR</b> Hour adjustment	1 – 12, [8] [Initial: 1 (1:00)]
<b>CLOCK MIN</b> Minute adjustment	00 – 59, [8] [Initial: 00 (1:00)]
<b>CLOCK DISP</b> Clock display	<b>CLOCK ON</b> : Clock time is shown on the display at all times even when the unit is turned off. <b>CLOCK OFF</b> : [Initial]; Clock time is shown when the unit is turned on. If the unit is turned off, pressing DISP will show the clock time for about 5 seconds.

**LEVELMETER**  
Audio level meter

You can select one of the four different level meter patterns or a demonstration of all the patterns.

**LEVEL ALL** [Initial] ⇄ **LEVEL 1** ⇄ **LEVEL 2** ⇄ **LEVEL 3** ⇄ **LEVEL 4** ⇄ **LEVEL OFF** (canceled) ⇄ (back to the beginning)

**LEVEL ALL** : Demonstrates all the level meter patterns, each for about 20 seconds.

**LEVEL 1**

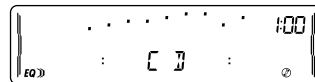

**LEVEL 2**

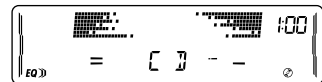

**LEVEL 3**

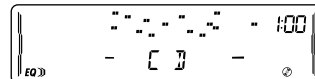

**LEVEL 4**

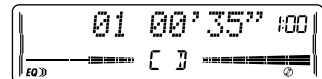

Indications	Selectable settings, [reference page]
<b>CLK ADJ</b> *1 Clock adjustment	<b>AUTO</b> : [Initial]; The built-in clock is automatically adjusted using the clock data provided via the satellite radio channel. <b>OFF</b> : Cancels.
<b>T-ZONE</b> *1, *2 Time zone	Select your residential area from one of the following time zones for clock adjustment. <b>EASTERN</b> [Initial] ⇄ <b>ATLANTIC</b> ⇄ <b>NEWFOUND</b> (Newfoundland) ⇄ <b>ALASKA</b> ⇄ <b>PACIFIC</b> ⇄ <b>MOUNTAIN</b> ⇄ <b>CENTRAL</b> ⇄ (back to the beginning).
<b>DST</b> *1, *2 Daylight saving time	Activate this if your residential area is subject to DST. <b>ON</b> : [Initial]; Activates daylight savings time. <b>OFF</b> : Cancels.
<b>SID</b> *3 SIRIUS® ID	The 12-digit SIRIUS identification number scrolls on the display 5 seconds after “SID” is selected, [24].
<b>DIMMER</b> Dimmer	<b>AUTO</b> : [Initial]; Dims the display when you turn on the headlights. <b>ON</b> : Activates dimmer. <b>OFF</b> : Cancels
<b>CONTRAST</b> Display contrast	<b>1 – 10</b> : Adjust the display contrast to make the display indications clear and legible. [Initial: 5]
<b>SCROLL</b> *4 Scroll	<b>ONCE</b> : [Initial]; Scrolls the disc information once. <b>AUTO</b> : Repeats scrolling (5-second intervals in between). <b>OFF</b> : Cancels. • Pressing DISP for more than one second can scroll the display regardless of the setting.

\*1 Displayed only when SIRIUS Satellite radio or XM Satellite radio is connected.

\*2 Displayed only when “CLK ADJ” is set to “AUTO.”

\*3 Displayed only when SIRIUS Satellite radio is connected.

\*4 Some characters or symbols will not be shown correctly (and will be blanked) or substituted on the display.

Indications	Selectable settings, [reference page]
<b>EXT INPUT</b> *1 External input	<b>CHANGER</b> : [Initial]; To use a JVC CD changer, [13], an Apple iPod or a JVC D. player, [23], a JVC compatible satellite (SIRIUS/XM) tuner, [24]. <b>EXT INPUT</b> : To use another external component, [23].
<b>AUX ADJUST</b> Auxiliary input level adjustment	<b>AUX ADJ 00 – AUX ADJ 05</b> : Adjust the auxiliary input level accordingly, to avoid the sudden increase of the output level when changing the source from external component connected to the AUX input jack on the control panel. [Initial: AUX ADJ 00]
<b>TAG DISP</b> Tag display	<b>TAG ON</b> : [Initial]; Shows the ID3 tag while playing MP3/WMA tracks, [15]. <b>TAG OFF</b> : Cancels.
<b>AMP GAIN</b> Amplifier gain control	You can change the maximum volume level of this unit. <b>LOW PWR</b> : VOLUME 00 – VOLUME 30 (Select this if the maximum power of the speaker is less than 50 W to avoid damaging the speaker.) <b>HIGH PWR</b> : [Initial]; VOLUME 00 – VOLUME 50
<b>IF FILTER</b> IF filter	<b>AUTO</b> : [Initial]; Increases the tuner selectivity to reduce interference noises between close stations. (Stereo effect may be lost.) <b>WIDE</b> : Subject to the interference noises from adjacent stations, but sound quality will not be degraded and maintains the stereo effect.
<b>AREA</b> Tuner channel interval	<b>AREA US</b> : [Initial]; Select this when using the unit in North or South America except for Middle South America. (FM: 200 kHz; AM: 10 kHz) <b>AREA EU</b> : Select this when using the unit in any other area than North, Middle South, and South America. (FM: 50 kHz—manual tuning, 100 kHz—auto search; AM: 9 kHz) <b>AREA SA</b> : Select this when using the unit in Middle South America. (FM: 100 kHz; AM: 10 kHz)

\*1 Cannot be selected if the source is “CD-CH” or “EXT.”

# External component operations

This unit is ready for operating an Apple iPod® or a JVC D. player from the control panel.

- For details, refer also to the manual supplied with the interface adapter for iPod®—KS-PD100 or D. player—KS-PD500.

## Playing an external component

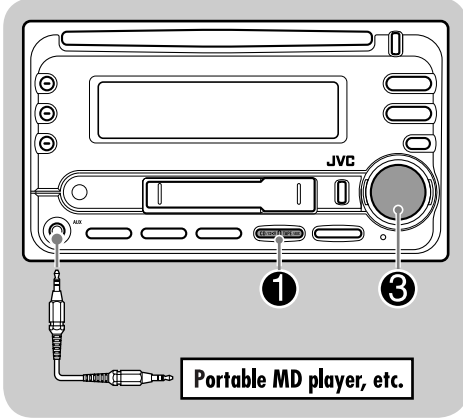

You can connect an external component to....

- CD changer jack on the rear using:
  - **Line Input Adapter**—KS-U57 (not supplied) or **AUX Input Adapter**—KS-U58 (not supplied) for any other components (except iPod or D. player).
  - **Interface adapter for iPod®**—KS-PD100 (not supplied) for controlling iPod.
  - **D. player interface adapter**—KS-PD500 (not supplied) for controlling D. player.
- AUX (auxiliary) input jack on the control panel.

For connection, see Installation/Connection Manual (separate volume).

- 1 For selecting the external component connected to....
  - **AUX input jack**

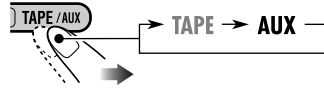

- **CD changer jack on the rear using KS-U57 or KS-U58**  
If “EXT” does not appear, see page 22 and select the external input (EXT INPUT).

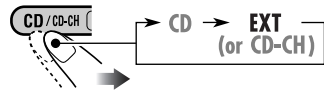

- **CD changer jack on the rear using interface adapter for iPod—KS-PD100 or for D. player—KS-PD500**

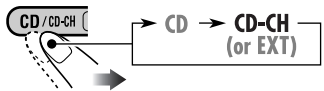

- 2 Turn on the connected component and start playing the source.
- 3 Adjust the volume.

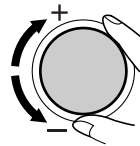

- 4 Adjust the sound as you want. (See pages 18 and 19.)

# Satellite radio operations

This unit is Satellite (SAT) Radio Ready—compatible with both SIRIUS Satellite radio and XM Satellite radio.

Before operating your satellite radio:

- For connection, see Installation/Connection Manual (separate volume).
- Refer also to the Instructions supplied with your SIRIUS Satellite radio or XM Satellite radio.
- “SIRIUS” and the SIRIUS dog logo are registered trademarks of SIRIUS Satellite Radio Inc.
- XM and its corresponding logos are registered trademarks of XM Satellite Radio Inc.
- “SAT Radio,” the SAT Radio logo and all related marks are trademarks of SIRIUS Satellite Radio Inc., and XM Satellite Radio, Inc.

## Listening to the satellite radio

Connect either one of the following (separately purchased) to the CD changer jack on the rear of this unit.

- **JVC SIRIUS radio DLP**—Down Link Processor, for listening to the SIRIUS Satellite radio.
- **XMDirect™ Universal Tuner Box using a JVC Smart Digital Adapter**—XMDJVC100 (not supplied), for listening to the XM Satellite radio.

GCI (Global Control Information) update:

- If channels are updated after subscription, updating starts automatically. “UPDATING” flashes and no sound can be heard.
- Update takes a few minutes to complete.
- During update, you cannot operate your satellite radio.

## Activate your SIRIUS subscription after connection:

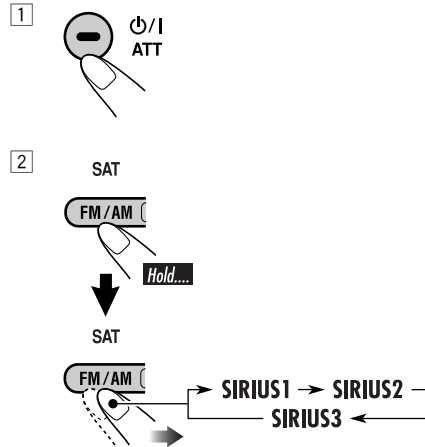

JVC DLP starts updating all the SIRIUS channels.

Once completed, JVC DLP tunes in to the preset channel, CH184.

- 3 **Check your SIRIUS ID, see page 21.**
- 4 **Contact SIRIUS on the internet at <<http://activate.siriusradio.com/>> to activate your subscription, or you can call SIRIUS toll-free at 1-888-539-SIRIUS (7474).**  
“SUB UPDT PRESS ANY KEY” scrolls on the display once subscription has been completed.

## Activate your XM subscription after connection:

- Only Channel 0, 1, and 247 are available before activation.

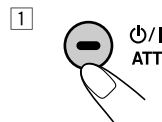

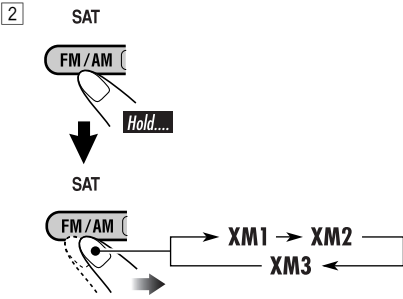

XMDirect™ Universal Tuner Box starts updating all the XM channels. “Channel 1” is tuned in automatically.

**3 Check your XM Satellite radio ID labelled on the casing of the XMDirect™ Universal Tuner Box, or tune in to “Channel 0” (see page 26).**

**4 Contact XM Satellite radio on the internet at <<http://xmradio.com/activation/>> to activate your subscription, or you can call 1-800-XM-RADIO (1-800-967-2346).** Once completed, the unit tunes in to one of the available channels (Channel 4 or higher).

Selecting a particular category (SPORTS, ENTERTAINMENT, etc.) allows you to enjoy only the channels from the selected category.

**3 Select a channel for listening.**

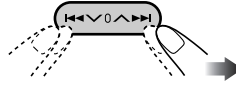

Holding the button changes the channels rapidly.

- When changing the category or channel, invalid and unsubscribed channels are skipped.

## Listening to the XM Satellite radio

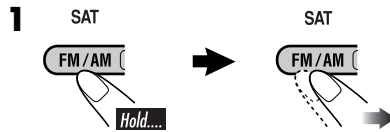

**2 Select a channel for listening.**

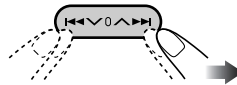

Holding the button changes the channels rapidly.

## Listening to the SIRIUS Satellite radio

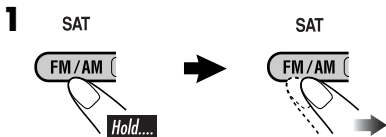

**2 Select a category.**

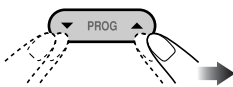

You can tune in to all the channels of every category by selecting “ALL.”

### ■ Category/channel search

You can search for programs by category (Category Search) or channel number (Channel Search).

- **In Category Search,** you can tune in to the channels of the selected category. Category Search begins from the currently selected channel. The selected channel number flashes on the display.
- **In Channel Search,** you can tune in to all the channels (including non-categorised channels).

*To be continued...*

**1 Select a category (Category Search).**

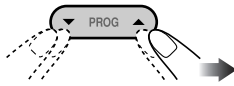

**2 Select a channel for listening.**

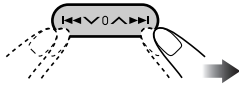

Current channel number



Ex.: When you select "COUNTRY" for Category Search

If no operation is done for about 7 seconds, Category Search is canceled.

In Channel Search, channel name and channel number appear on the display during search.

- While searching, invalid and unsubscribed channels are skipped.

**Checking the XM Satellite radio ID**

While selecting "XM1," "XM2," or "XM3," select "Channel 0."

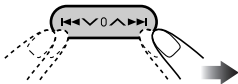

The display alternately shows "RADIO ID" and the 8-digit (alphanumeric) ID number.

To cancel the ID number display, select any channel other than "Channel 0."

**Storing channels in memory**

You can preset six channels for each band.

Ex.: Storing a channel into preset number 4.

**1 Tune in to a channel you want.**

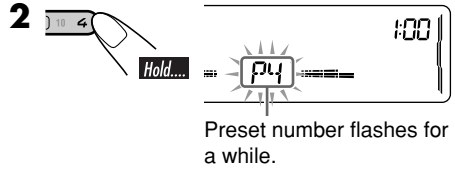

Preset number flashes for a while.

**Listening to a preset channel**

**1 Select either SIRIUS Satellite radio or XM Satellite radio.**

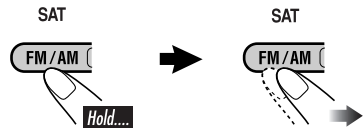

**2 Select the preset channel (1 – 6) you want.**

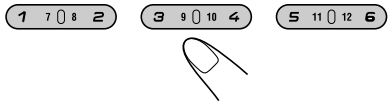

**To change the display information while listening to a channel**

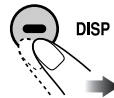

Category name → Channel name → Artist name  
 → Composer name\* → Song/program name/title  
 → (back to the beginning)

\* Only for SIRIUS Satellite radio.



## Handling discs

### Moisture condensation

Moisture may condense on the lens inside the CD player in the following cases:

- After starting the heater in the car.
- If it becomes very humid inside the car.

Should this occur, the CD player may malfunction. In this case, eject the disc and leave the unit turned on for a few hours until the moisture evaporates.

### How to handle discs

When removing a disc from its case, press down the center holder of the case and lift the disc out, holding it by the edges.

Center holder



- Always hold the disc by the edges. Do not touch its recording surface.

When storing a disc into its case, gently insert the disc around the center holder (with the printed surface facing up).

- Make sure to store discs into the cases after use.

### To keep discs clean

A dirty disc may not play correctly. If a disc does become dirty, wipe it with a soft cloth in a straight line from center to edge.



- Do not use any solvent (for example, conventional record cleaner, spray, thinner, benzene, etc.) to clean discs.

### To play new discs

New discs may have some rough spots around the inner and outer edges. If such a disc is used, this unit may reject the disc.



To remove these rough spots, rub the edges with a pencil or ball-point pen, etc.

### Do not use the following discs:

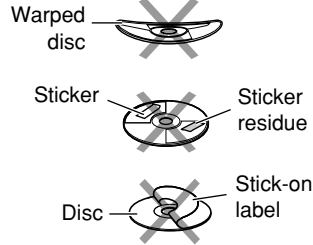

## Handling cassettes

### To clean the head

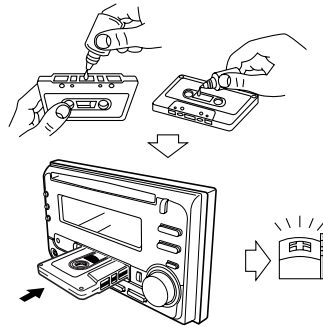

- Clean the heads after every 10 hours of use using a wet-type head cleaning tape (available at an audio store).

When the head becomes dirty, you may realize the following symptoms:

- Sound quality is reduced.
  - Sound level decreases.
  - Sound drops out.
- Do not touch the highly-polished head with any metallic or magnetic tools.

### To keep the tape clean

- Always store the cassettes in their storage cases after use.
- Do not store cassettes in the following places:
  - Subject to direct sunlight
  - With high humidity
  - At extremely hot temperatures

# More about this unit

## Basic operations

### Turning on the power

- By pressing the source buttons on the unit, you can also turn on the power. If the source is ready, playback also starts.

### Turning off the power

- If you turn off the ignition key without turning off this unit, the unit will automatically turn on when you turn on the ignition key next time. If the last selected source is ready for playback (ex. a disc or a tape is in the unit), playback starts automatically.
- If you turn off the power while listening to a disc, disc play will start from where playback has been stopped previously, next time you turn on the power.

### Selecting the sources

- When no disc or cassette is loaded in the unit, "CD" or "TAPE" cannot be selected.
- "SIRIUS," "XM," or "CD-CH" cannot be selected when the target component is not connected.

## Tuner operations

### Storing stations in memory

- During SSM search...
  - All previously stored stations are erased and stations are stored newly.
  - Received stations are preset in No. 1 (lowest frequency) to No. 6 (highest frequency).
  - When SSM is over, the station stored in No. 1 will be automatically tuned in.
- When storing a station manually, the previously preset station is erased when a new station is stored in the same preset number.

## Disc operations

### Caution for DualDisc playback

- The Non-DVD side of a "DualDisc" does not comply with the "Compact Disc Digital Audio" standard. Therefore, the use of Non-DVD side of a DualDisc on this product may not be recommended.

### General

- MP3 and WMA (Windows Media® Audio) "tracks" (words "file" and "track" are used interchangeably) are recorded in "folders."
- This unit has been designed to reproduce CDs/CD Texts, and CD-Rs (Recordable)/CD-RWs (Rewritable) in audio CD (CD-DA), MP3 and WMA format.
- When a disc has been loaded, selecting "CD" for the playback source starts disc play.

### Inserting a disc

- When a disc is inserted upside down, the disc automatically ejects and the unit starts playing the last selected source.
- Do not insert 8 cm (3-3/16") discs (single CD) and unusual shape discs (heart, flower, etc.) into the loading slot.

### Playing a disc

- While fast-forwarding or reversing on an MP3 or WMA disc, you can only hear intermittent sounds.

## **Playing a CD-R or CD-RW**

- Use only “finalized” CD-Rs or CD-RWs.
- This unit can play back only files of the same type which are first detected if a disc includes both audio CD (CD-DA) files and MP3/WMA files.
- This unit can play back multi-session discs; however, unclosed sessions will be skipped while playing.
- Some CD-Rs or CD-RWs may not play back on this unit because of their disc characteristics, or for the following reasons:
  - Discs are dirty or scratched.
  - Moisture condensation occurs on the lens inside the unit.
  - The pickup lens inside the unit is dirty.
  - CD-R/CD-RW on which the files are written with “Packet Write” method.
  - There are improper recording conditions (missing data, etc.) or media conditions (stained, scratched, warped, etc.).
- CD-RWs may require a longer readout time since the reflectance of CD-RWs is lower than that of regular CDs.
- Do not use the following CD-Rs or CD-RWs:
  - Discs with stickers, labels, or protective seal stuck to the surface.
  - Discs on which labels can be directly printed by an ink jet printer.
 Using these discs under high temperatures or high humidity may cause malfunctions or damage to the unit.

## **Playing an MP3/WMA disc**

- This unit can play back MP3/WMA files with the extension code <.mp3> or <.wma> (regardless of the letter case—upper/lower).
- This unit can show the names of albums, artists (performer), and ID3 Tag (Version 1.0, 1.1, 2.2, 2.3, or 2.4) for MP3 files and for WMA files.
- This unit can display only one-byte characters. No other characters can be correctly displayed (see page 11).

- This unit can play back MP3/WMA files meeting the conditions below:
  - Bit rate: 8 kbps — 320 kbps
  - Sampling frequency:
    - 48 kHz, 44.1 kHz, 32 kHz (for MPEG-1)
    - 24 kHz, 22.05 kHz, 16 kHz (for MPEG-2)
    - 48 kHz, 44.1 kHz, 32 kHz (for WMA)
  - Disc format: ISO 9660 Level 1/ Level 2, Romeo, Joliet, Windows long file name
- The maximum number of characters for file/folder names vary among the disc format used (includes 4 extension characters—<.mp3> or <.wma>).
  - ISO 9660 Level 1: up to 12 characters
  - ISO 9660 Level 2: up to 31 characters
  - Romeo\*: up to 128 (72) characters
  - Joliet\*: up to 64 (36) characters
  - Windows long file name\*: up to 128 (72) characters

\* *The parenthetic figure is the maximum number of characters for file/folder names in case the total number of files and folders is 313 or more.*
- This unit can recognize a total of 512 files, of 200 folders, and of 8 hierarchies.
- This unit can play back files recorded in VBR (variable bit rate).  
Files recorded in VBR have a discrepancy in elapsed time display, and do not show the actual elapsed time. This difference becomes noticeable especially after performing the search function.
- This unit cannot play back the following files:
  - MP3 files encoded with MP3i and MP3 PRO format.
  - MP3 files encoded in an unappropriated format.
  - MP3 files encoded with Layer 1/2.
  - WMA files encoded with lossless, professional, and voice format.
  - WMA files which are not based upon Windows Media® Audio.
  - WMA files copy-protected with DRM.
  - Files which have the data such as WAVE, ATRAC3, etc.
- The search function works but search speed is not constant.

*To be continued....*

## Changing the source

- If you change the source, playback also stops (without ejecting the disc).  
Next time you select “CD” or “CD-CH” for the playback source, disc play starts from where it has been stopped previously.

## Ejecting a disc

- If the ejected disc is not removed within 15 seconds, the disc is automatically inserted again into the loading slot to protect it from dust. (Disc will not play this time.)

## Tape operations

### Playing a tape

- While locating a specified tune:
  - If the tape is rewound to its beginning, playback starts from the beginning of that side.
  - If the tape is fast-forwarded to the end, it is reversed and played from the beginning of the other side.
- In the following cases, Multi Music Scan (MMS), Blank Skip, and Repeat Play may not operate correctly:
  - Tapes with tunes having long pianissimo passages (very quiet parts) or non-recorded portions.
  - Tapes with short non-recorded sections.
  - Tapes with high level noise or humming between tunes.
  - The Dolby NR setting does not match. For example, if the tape is recorded with the Dolby C NR.
- Do not use the following tape:
  - Dirty or dusty tapes.
  - Cassette with peeling labels.
  - Loose tape which may become entangled with the mechanism.

- Microsoft and Windows Media are either registered trademarks or trademarks of Microsoft Corporation in the United States and/or other countries.

## Changing the source

- If you change the source, playback also stops (without ejecting the cassette).

## Ignition key-off release

- When you turn off the ignition key with a cassette in the compartment, the unit automatically releases the tape from its head.

## General settings—PSM

- If you change the “TAG DISP” setting from “TAG OFF” to “TAG ON” while playing MP3/WMA file, the tag display will be activated when the next file starts playing.
- If you change the “AMP GAIN” setting from “HIGH PWR” to “LOW PWR” while the volume level is set higher than “VOLUME 30,” the unit automatically changes the volume level to “VOLUME 30.”

## Other main functions

- If you try to assign a title to the 31st station frequency, “NAME FULL” flashes. Delete unwanted titles before assignment.

## Satellite radio operations

- You can also connect the JVC SIRIUS radio PnP (Plug and Play), using the JVC SIRIUS radio adapter, KS-U100K (not supplied) to the CD changer jack on the rear.  
By turning on the power of the unit, you can turn on/off the JVC PnP. However, you cannot control it from this unit.
- To know more about SIRIUS Satellite radio or to sign up, visit <<http://www.sirius.com>>.
- For the latest channel listings and programming information, or to sign up for XM Satellite radio, visit <<http://www.xmradio.com>>.

# Troubleshooting

What appears to be trouble is not always serious. Check the following points before calling a service center.

	Symptoms	Remedies/Causes
<b>General</b>	• Sound cannot be heard from the speakers.	• Adjust the volume to the optimum level. • Check the cords and connections.
	• The unit does not work at all.	Reset the unit (see page 2).
<b>FM/AM</b>	• SSM automatic presetting does not work.	Store stations manually.
	• Static noise while listening to the radio.	Connect the antenna firmly.
<b>Disc playback</b>	• Disc cannot be played back.	Insert the disc correctly.
	• CD-R/CD-RW cannot be played back.	• Insert a finalized CD-R/CD-RW.
	• Tracks on the CD-R/CD-RW cannot be skipped.	• Finalize the CD-R/CD-RW with the component which you used for recording.
	• Disc can be neither played back nor ejected.	• Unlock the disc (see page 15). • Eject the disc forcibly (see page 2).
	• Disc sound is sometimes interrupted.	• Stop playback while driving on rough roads. • Use an unscratched disc. • Check the cords and connections.
	• “NO DISC” appears on the display.	Insert a correct disc into the loading slot.
<b>MP3/WMA playback</b>	• Disc cannot be played back.	• Use a disc with MP3/WMA tracks recorded in the format compliant with ISO 9660 Level 1, Level 2, Romeo, or Joliet. • Add the extension code <.mp3> or <.wma> to the file names.
	• Noise is generated.	Skip to another track or change the disc. (Do not add the extension code <.mp3> or <.wma> to non-MP3 or WMA tracks.)
	• A longer readout time is required (“CHECK” keeps flashing on the display).	Do not use too many hierarchies and folders.
	• Tracks do not play back in the order you have intended them to play.	Playback order is determined when the files are recorded.
	• Elapsed playing time is not correct.	This sometimes occurs during play. This is caused by how the tracks are recorded on the disc.
	• “NO FILES” appears on the display.	Insert a disc that contains MP3/WMA tracks.
<b>Tape playback</b>	• A cassette cannot be inserted.	Insert the cassette with the exposed tape facing right.
	• Cassette can be neither played back nor ejected.	Unlock the cassette (see page 17).
	• “NO TAPE” appears on the display.	Insert a cassette correctly.
	• Cassette tapes become hot.	This is not a malfunction.
	• Tape sound is at very low level and sound quality is degraded.	Clean the tape head using a head cleaning tape.

To be continued....

	Symptoms	Remedies/Causes
CD changer	<ul style="list-style-type: none"> <li>• “NO DISC” appears on the display.</li> </ul>	Insert a disc into the magazine.
	<ul style="list-style-type: none"> <li>• “NO MAG” appears on the display.</li> </ul>	Insert the magazine.
	<ul style="list-style-type: none"> <li>• “RESET 8” appears on the display.</li> </ul>	Connect this unit and the CD changer correctly and press the reset button of the CD changer.
	<ul style="list-style-type: none"> <li>• “RESET 1” – “RESET 7” appears on the display.</li> </ul>	Press the reset button of the CD changer.
	<ul style="list-style-type: none"> <li>• The CD changer does not work at all.</li> </ul>	Reset the unit (see page 2).
Satellite radio	<ul style="list-style-type: none"> <li>• “CALL 1-888-539-SIRIUS TO SUBSCRIBE” scrolls on the display while listening to the SIRIUS Satellite radio.</li> </ul>	Starts subscribing SIRIUS Satellite radio (see page 24).
	<ul style="list-style-type: none"> <li>• No sound can be heard. “UPDATING” appears on the display.</li> </ul>	The unit is updating the channel information and it takes a few minutes to complete.
	<ul style="list-style-type: none"> <li>• Either “NO SIGNAL” scrolls or “NO SIGNL” appears on the display.</li> </ul>	Move to an area where signals are stronger.
	<ul style="list-style-type: none"> <li>• Either “NO ANTENNA” scrolls or “ANTENNA” appears on the display.</li> </ul>	Connect the antenna firmly.
	<ul style="list-style-type: none"> <li>• “NO CH” appears on the display for about 5 seconds, then returns to the previous display while listening to the SIRIUS Satellite radio.</li> </ul>	No broadcast on the selected channel. Select another channel or continue listening to the previous channel.
	<ul style="list-style-type: none"> <li>• “NO (information)*” scrolls on the display while listening to the SIRIUS Satellite radio.</li> <li>• “---” appears on the display while listening to the XM Satellite radio.</li> </ul>	No text information for the selected channel.
	<ul style="list-style-type: none"> <li>• “---” appears on the display for about 2 seconds, then returns to the previous channel while listening to the XM Satellite radio.</li> </ul>	Selected channel is no longer available or is unauthorized. Select another channel or continue listening to the previous channel.
	<ul style="list-style-type: none"> <li>• “OFF AIR” appears on the display while listening to the XM Satellite radio.</li> </ul>	Selected channel is not broadcasting at this time. Select another channel or continue listening to the previous channel.
	<ul style="list-style-type: none"> <li>• “LOADING” appears on the display while listening to the XM Satellite radio.</li> </ul>	The unit is loading the channel information and audio. Text information are temporarily unavailable.
	<ul style="list-style-type: none"> <li>• “RESET 8” appears on the display.</li> <li>• Satellite radio does not work at all.</li> </ul>	Reconnect this unit and the satellite radio correctly and press the reset button of this unit.

\* NO CATEGORY, NO ARTIST, NO COMPOSER, and NO SONG/PROGRAM

# Specifications

## AUDIO AMPLIFIER SECTION

Power Output:  
18 W RMS × 4 Channels at 4 Ω  
and ≤ 1% THD+N  
Signal to Noise Ratio:  
80 dBA (reference: 1 W into 4 Ω)



Load Impedance: 4 Ω (4 Ω to 8 Ω allowance)  
Equalizer Control Range:  
Low: ±12 dB (60 Hz, 80 Hz, 100 Hz, 120 Hz)  
Mid: ±12 dB  
High: ±12 dB (8 kHz, 10 kHz, 12 kHz, 15 kHz)  
Frequency Response: 40 Hz to 20 000 Hz  
Line-Out Level/Impedance:  
2.0 V/20 kΩ load (full scale)  
Output Impedance: 1 kΩ  
Other Terminals: CD changer, AUX  
(auxiliary) input jack,  
Steering wheel remote input

## TUNER SECTION

Frequency Range:  
FM: 87.5 MHz to 107.9 MHz  
(with channel interval set to 100 kHz  
or 200 kHz)  
87.5 MHz to 108.0 MHz  
(with channel interval set to 50 kHz)  
AM: 530 kHz to 1 710 kHz  
(with channel interval set to 10 kHz)  
531 kHz to 1 602 kHz  
(with channel interval set to 9 kHz)

### [FM Tuner]

Usable Sensitivity: 11.3 dBf (1.0 μV/75 Ω)  
50 dB Quieting Sensitivity:  
16.3 dBf (1.8 μV/75 Ω)  
Alternate Channel Selectivity (400 kHz): 65 dB  
Frequency Response: 40 Hz to 15 000 Hz  
Stereo Separation: 35 dB  
Capture Ratio: 1.5 dB

### [AM Tuner]

Sensitivity: 20 μV  
Selectivity: 35 dB

## CD PLAYER SECTION

Type: Compact disc player  
Signal Detection System: Non-contact optical  
pickup (semiconductor laser)  
Number of Channels: 2 channels (stereo)  
Frequency Response: 5 Hz to 20 000 Hz  
Dynamic Range: 96 dB  
Signal-to-Noise Ratio: 98 dB  
Wow and Flutter: Less than measurable limit  
MP3 Decoding Format:  
MPEG1/2 Audio Layer 3  
Max. Bit Rate: 320 kbps  
WMA (Windows Media® Audio) Decoding  
Format:  
Max. Bit Rate: 192 kbps

## CASSETTE DECK SECTION

Wow and Flutter: 0.1 % (WRMS)  
Fast-Wind Time: 100 sec. (C-60)  
Frequency Response: 30 Hz to 16 000 Hz  
(Normal tape)  
Signal-to-Noise Ratio: (Normal tape)  
Dolby B NR ON: 65 dB  
Dolby B NR OFF: 56 dB  
Stereo Separation: 40 dB

## GENERAL

Power Requirement:  
Operating Voltage:  
DC 14.4 V (11 V to 16 V allowance)  
Grounding System: Negative ground  
Allowable Operating Temperature:  
0°C to +40°C (32°F to 104°F)  
Dimensions (W × H × D):  
Installation Size (approx.):  
178 mm × 100 mm × 158 mm  
(7-1/16" × 3-15/16" × 6-1/4")  
Set Size (approx.):  
178 mm × 100 mm × 175 mm  
(7-1/16" × 3-15/16" × 6-15/16")  
Mass (approx.):  
2.3 kg (5.1 lbs) (excluding accessories)

*Design and specifications are subject to change without notice.*

If a kit is necessary for your car, consult your telephone directory for the nearest car audio speciality shop.



**Having TROUBLE with operation?  
Please reset your unit  
Refer to page of How to reset your unit  
Still having trouble??**

**USA ONLY**

**Call 1-800-252-5722**

**<http://www.jvc.com>**

**We can help you!**

**JVC**



EN, SP, FR

© 2005 Victor Company of Japan, Limited

1105DTSMDTJEIN



# JVC KW-XC410/KW-XC400

## Installation/Connection Manual

## Manual de instalación/conexión

## Manuel d'installation/raccordement

GET0320-002B  
[J]

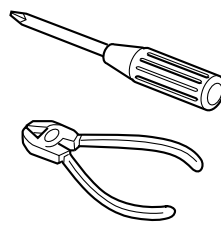

1105DTSMDTJEIN  
EN, SP, FR

© 2005 Victor Company of Japan, Limited

### ENGLISH

This unit is designed to operate on **12 V DC, NEGATIVE ground electrical systems**. If your vehicle does not have this system, a voltage inverter is required, which can be purchased at JVC car audio dealers.

### ESPAÑOL

Esta unidad está diseñada para funcionar con **12 V de CC, con sistemas eléctricos de masa NEGATIVA**. Si su vehículo no posee este sistema, será necesario un inversor de tensión, que puede ser adquirido en los concesionarios de JVC de equipos de audio para automóviles.

### FRANÇAIS

Cet appareil est conçu pour fonctionner sur des sources de courant continu de **12 V à masse NEGATIVE**. Si votre véhicule n'offre pas ce type d'alimentation, il vous faut un convertisseur de tension, que vous pouvez acheter chez un revendeur d'autoradios JVC.

#### Parts list for installation and connection

The following parts are provided for this unit. After checking them, please set them correctly.

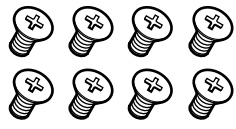

Flat countersunk screws—M5 × 8 mm (M5 × 3/8")  
Tornillos de cabeza avellanada plana—M5 × 8 mm (M5 × 3/8 pulgada)  
Vis plat à tête fraisée—M5 × 8 mm (M5 × 3/8 pouces)



Binding screws—M5 × 8 mm (M5 × 3/8")  
Tornillos de fijación—M5 × 8 mm (M5 × 3/8 pulgada)  
Vis de serrage—M5 × 8 mm (M5 × 3/8 pouces)

#### Lista de piezas para instalación y conexión

Con esta unidad se suministran las siguientes piezas. Después de inspeccionarlas, colóquelas correctamente.

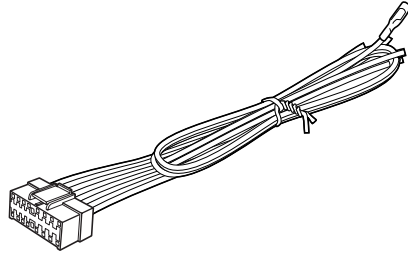

Power cord  
Cordón de alimentación  
Cordon d'alimentation



CR2025

Battery  
Pila  
Pile

#### Liste des pièces pour l'installation et raccordement

Les pièces suivantes sont fournies avec cet appareil. Après vérification, veuillez les placer correctement.

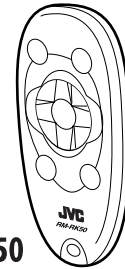

RM-RK50

Remote controller  
Control remoto  
Télécommande

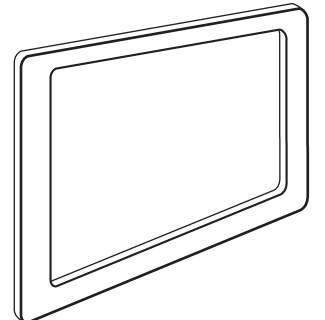

Plate for use with a Nissan car  
Placa para usar con un automóvil Nissan  
Plaque à utiliser avec une voiture Nissan

#### When installing the unit in a Nissan car

#### Quando instale la unidad en un automóvil Nissan

#### Lors de l'installation de l'appareil dans une voiture Nissan

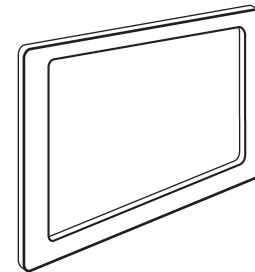
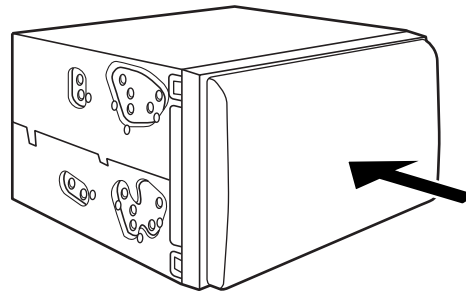
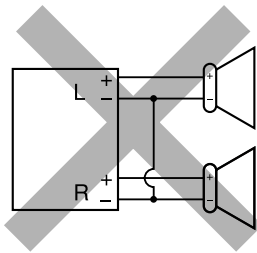

Plate for use with a Nissan car  
Placa para usar con un automóvil Nissan  
Plaque à utiliser avec une voiture Nissan

Fix the supplied plate as illustrated.  
Fije la placa suministrada de la manera indicada en la ilustración.  
Fixez la plaque fournie comme montré sur l'illustration.

#### PRECAUTIONS on power supply and speaker connections:

- **DO NOT connect the speaker leads of the power cord to the car battery; otherwise, the unit will be seriously damaged.**
- BEFORE connecting the speaker leads of the power cord to the speakers, check the speaker wiring in your car.



#### PRECAUCIONES sobre las conexiones de la fuente de alimentación y de los altavoces:

- **NO conecte los conductores de altavoz del cable de alimentación a la batería de automóvil, pues podrían producirse graves daños en la unidad.**
- ANTES de conectar a los altavoces los conductores de altavoz del cable de alimentación, verifique el conexionado de altavoz de su automóvil.

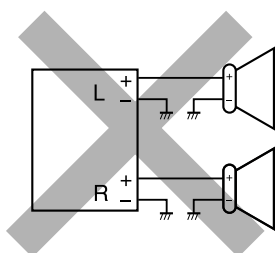

#### PRECAUTIONS sur l'alimentation et la connexion des enceintes:

- **NE CONNECTEZ PAS les fils d'enceintes du cordon d'alimentation à la batterie; sinon, l'appareil serait sérieusement endommagé.**
- AVANT de connecter les fils d'enceintes du cordon d'alimentation aux enceintes, vérifiez le câblage des enceintes de votre voiture.

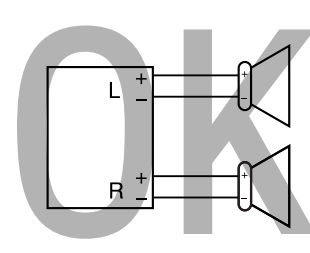

### TROUBLESHOOTING

- **The fuse blows.**  
\* Are the red and black leads connected correctly?
- **Power cannot be turned on.**  
\* Is the yellow lead connected?
- **No sound from the speakers.**  
\* Is the speaker output lead short-circuited?
- **Sound is distorted.**  
\* Is the speaker output lead grounded?  
\* Are the "-" terminals of L and R speakers grounded in common?
- **Noise interferes with sounds.**  
\* Is the rear ground terminal connected to the car's chassis using shorter and thicker cords?
- **This unit becomes hot.**  
\* Is the speaker output lead grounded?  
\* Are the "-" terminals of L and R speakers grounded in common?
- **This unit does not work at all.**  
\* Have you reset your unit?

### LOCALIZACION DE AVERIAS

- **El fusible se quema.**  
\* ¿Están los conductores rojo y negro correctamente conectados?
- **No es posible conectar la alimentación.**  
\* ¿Está el cable amarillo conectado?
- **No sale sonido de los altavoces.**  
\* ¿Está el cable de salida del altavoz cortocircuitado?
- **El sonido presenta distorsión.**  
\* ¿Está el cable de salida del altavoz conectado a masa?  
\* ¿Están los terminales "-" de los altavoces L y R conectados a una masa común?
- **Perturbación de ruido.**  
\* ¿El terminal de tierra trasero está conectado al chasis del automóvil utilizando los cordones más corto y más grueso?
- **La unidad se calienta.**  
\* ¿Está el cable de salida del altavoz conectado a masa?  
\* ¿Están los terminales "-" de los altavoces L y R conectados a una masa común?
- **Este receptor no funciona en absoluto.**  
\* ¿Reinicializó el receptor?

### EN CAS DE DIFFICULTES

- **Le fusible saute.**  
\* Les fils rouge et noir sont-ils raccordés correctement?
- **L'appareil ne peut pas être mise sous tension.**  
\* Le fil jaune est-elle raccordée?
- **Pas de son des enceintes.**  
\* Le fil de sortie d'enceinte est-il court-circuité?
- **Le son est déformé.**  
\* Le fil de sortie d'enceinte est-il à la masse?  
\* Les bornes "-" des enceintes gauche et droit sont-elles mises ensemble à la masse?
- **Interférence avec les sons.**  
\* La prise arrière de mise à la terre est-elle connectée au châssis de la voiture avec un cordon court et épais?
- **L'appareil devient chaud.**  
\* Le fil de sortie d'enceinte est-il à la masse?  
\* Les bornes "-" des enceintes gauche et droit sont-elles mises ensemble à la masse?
- **Cet appareil ne fonctionne pas du tout.**  
\* Avez-vous réinitialisé votre appareil?

## INSTALLATION (IN-DASH MOUNTING)

The following illustration shows a typical installation. However, you should make adjustments corresponding to your specific car. In this case consult the manual included with the installation kit (option). In some case, depending of the type and the model of your car, it is not possible to install the unit into the center console. If you have any questions or require information regarding installation kits, consult your JVC car audio dealers or a company supplying kits.

- If you are not sure how to install this unit correctly, have it installed by a qualified technician.

### Before installing the unit

- When mounting the unit, be sure to use the screws provided, as instructed. If other screws are used, there is a possibility that parts could become loose or damaged.
- When tightening screws or bolts be careful not to pinch any connection cord.

- 1 Remove the audio system originally installed together with the mounting brackets.  
**Note:** Be sure to keep all the screws and parts removed from your car for future use.
- 2 Attach the mounting brackets (removed from the car), to this unit (see below).
- 3 Connect the wires (see diagram **A**).
- 4 Fix this unit to the car using the screws removed in step 1.  
• See "Caution" below.

The following example shown is for installation in a Toyota car. For more details, consult your JVC car audio dealer.

## INSTALACION (MONTAJE EN EL TABLERO DE INSTRUMENTOS)

La siguiente ilustración muestra una instalación típica. Sin embargo, deberá realizar los ajustes que correspondan a su automóvil. En tal caso, consulte el manual entregado con el kit de instalación (opción).

En algunos casos, y dependiendo del tipo y modelo de su automóvil, es posible que no se pueda instalar esta unidad en la consola central. Si tiene alguna pregunta o necesita información acerca de las herramientas para instalación, consulte con su concesionario de JVC de equipos de audio para automóviles o a una compañía que suministra tales herramientas.

- Si usted no está seguro de cómo instalar correctamente la unidad, hágala instalar por un técnico cualificado.

### Antes de instalar la unidad

- Al instalar la unidad, asegúrese de usar los tornillos suministrados, tal como se especifica. Si utiliza otros tornillos, puede suceder que las piezas se aflojen o dañen.
- Al apretar los tornillos o los pernos, tenga cuidado de no pillar ningún cable de conexión.

- 1 Desmonte el sistema de audio instalado originalmente junto con los soportes de montaje.  
**Nota:** Asegúrese de guardar todos los tornillos y piezas quitados de su vehículo para poderlos usar en el futuro.
- 2 Fije los soportes de montaje (removidos del vehículo) a esta unidad (véase abajo).
- 3 Conecte los cables (véase el diagrama **A**).
- 4 Fije esta unidad al automóvil usando los tornillos quitados en el paso 1.  
• Véase "Precaución" más abajo.

El ejemplo siguiente muestra la instalación de un automóvil Toyota. Para mayor información, consulte con su concesionario car audio JVC.

## INSTALLATION (MONTAGE DANS LE TABLEAU DE BORD)

L'illustration suivante est un exemple d'installation typique. Cependant, vous devez réaliser les ajustements correspondant à votre propre voiture. Dans ce cas, consultez le manuel fourni avec le kit d'installation (optionnel). Dans certains cas, en fonction du type de modèle de votre voiture, il n'est pas possible d'installer l'appareil dans la console centrale. Si vous avez des questions ou avez besoin d'information sur des kits d'installation, consultez votre revendeur d'autoradios JVC ou une compagnie d'approvisionnement.

- Si l'on n'est pas sûr de pouvoir installer correctement cet appareil, le faire installer par un technicien qualifié.

### Avant d'installer l'appareil

- Lors du montage de l'appareil, assurez-vous d'utiliser les vis fournies de la façon indiquée. Si vous utilisez d'autres vis, certaines pièces peuvent devenir lâches ou être endommagées.
- Lors du serrage de vis ou de boulons, faites attention de ne pas pincer de cordon de connexion.

- 1 Retirez le système audio d'origine installé en même temps que les supports de montage.  
**Remarque:** Assurez-vous de conserver toutes les vis et pièces détachées de votre voiture pour une utilisation dans le futur.
- 2 Fixez les supports de montage (retirés de la voiture) à cet appareil (voir ci-dessous).
- 3 Connectez le fils (voir le diagramme **A**).
- 4 Fixez cet appareil à la voiture en utilisant les vis retirées à l'étape 1.  
• Référez-vous aux "Précautions" ci-dessous.

Les exemples montrés ci-dessous correspondent à une installation dans une voiture Toyota. Pour plus de détails, consultez votre revendeur autoradio JVC.

Securely connect the ground wire to the metal body of the car using the screw originally fixed to the metal body of the car. Connecte fermement le câble de terre à la carrosserie métallique du véhicule en utilisant le vis fixée à l'origine au châssis métallique de la voiture.

Mounting bracket removed from the car  
Soporte de montaje removido del automóvil  
Support de montage retiré de la voiture

Screws supplied for this unit  
Tornillos suministrados para esta unidad  
Vis fournis avec cet appareil

Mounting bracket removed from the car  
Soporte de montaje removido del automóvil  
Support de montage retiré de la voiture

Screws supplied for this unit  
Tornillos suministrados para esta unidad  
Vis fournis avec cet appareil

Screw removed from the car in step 1  
Tornillo removido del automóvil en el paso 1  
Vis retiré de la voiture à l'étape 1

### Screws supplied for this unit: Tornillos suministrados para esta unidad: Vis fournis avec cet appareil:

Select the proper screw type, fitting to your car.  
Seleccione el tipo de rosca correcto, adecuado a su automóvil.  
Choisissez le type de vis correct, en fonction de votre voiture.

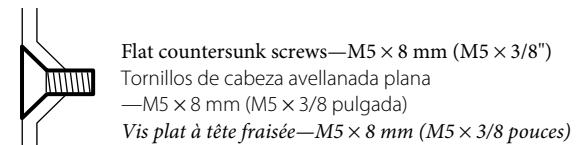
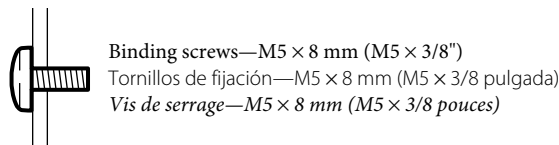

### Caution:

To install the mounting brackets to the unit, use only the supplied screws—M5 × 8 mm (M5 × 3/8"). If you use any screw longer than 8 mm (3/8"), the unit can be damaged.

### Precaución:

Para instalar los soportes de montaje en la unidad, utilice solamente los tornillos suministrados—M5 × 8 mm (M5 × 3/8 pulgada). El uso de cualquier tornillo de más de 8 mm (3/8 pulgada), de largo puede producir daños a la unidad.

### Précautions:

Pour installer les supports de montage sur l'appareil, utilisez uniquement les vis fournies—M5 × 8 mm (M5 × 3/8 pouces). Si vous utilisez une vis plus longue que 8 mm (3/8 pouces), l'appareil peut être endommagé.

If there is an interfering tab on the mounting bracket, bent it flat.  
Si hay alguna lengüeta que interfiere con el soporte de montaje, dóblela hasta que quede plana.  
S'il y a une languette gênante sur le support de montage, aplatissez-la.

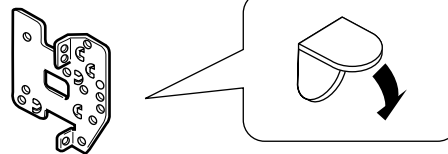

Install the unit at an angle of less than 30°.  
Instale la unidad a un ángulo de menos de 30°.  
Installez l'appareil avec un angle de moins de 30°.

Less than 30°  
Menos de 30°.  
Moins de 30°.

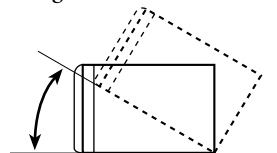

## ELECTRICAL CONNECTIONS

To prevent short circuits, we recommend that you disconnect the battery's negative terminal and make all electrical connections before installing the unit.

- Be sure to ground this unit to the car's chassis again after installation.

### Notes:

- Replace the fuse with one of the specified rating. If the fuse blows frequently, consult your JVC car audio dealer.
- If noise is a problem...  
This unit incorporates a noise filter in the power circuit. However, with some vehicles, clicking or other unwanted noise may occur. If this happens, connect the unit's rear ground terminal to the car's chassis using shorter and thicker cords, such as copper braiding or gauge wire. If noise still persists, consult your JVC car audio dealer.
- It is recommended to connect to the speakers with maximum power of more than 50 W (both at the rear and at the front, with an impedance of 4 Ω to 8 Ω). If the maximum power is less than 50 W, change "AMP GAIN" setting to prevent the speakers from being damaged (see page 22 of the INSTRUCTIONS).
- The heat sink becomes very hot after use. Be careful not to touch it when removing this unit.

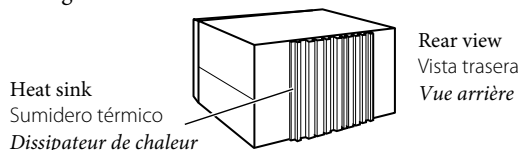

## CONEXIONES ELECTRICAS

Para evitar cortocircuitos, recomendamos que desconecte el terminal negativo de la batería y que efectúe todas las conexiones eléctricas antes de instalar la unidad.

- Asegúrese de volver a conectar a masa esta unidad al chasis del automóvil después de la instalación.

### Notas:

- Reemplace el fusible por uno con la corriente especificada. Si el fusible se quemase frecuentemente consulte con su concesionario de JVC de equipos de audio para automóviles.
- Si el ruido es un problema...  
Esta unidad incorpora un filtro de ruido en el circuito de alimentación. Sin embargo, en algunos vehículos, pueden producirse chasquidos u otros ruidos indeseables. En tal caso, conecte el terminal de tierra trasero de la unidad al chasis del automóvil utilizando cables más cortos y gruesos, como por ejemplo, cables de cobre estañado o conductor. Si los ruidos persisten, consulte con su concesionario car audio JVC.
- Se recomienda conectar los altavoces con una potencia máxima de más de 50 W (tanto atrás como adelante, con una impedancia de 4 Ω a 8 Ω). Si la potencia máxima es de menos de 50 W, cambie "AMP GAIN" para evitar daños en los altavoces (consulte la página 22 del MANUAL DE INSTRUCCIONES).
- El sumidero térmico estará muy caliente después del uso. Asegúrese de no tocarlo al desmontar esta unidad.

## RACCORDEMENTS ELECTRIQUES

Pour éviter tout court-circuit, nous vous recommandons de débrancher la borne négative de la batterie et d'effectuer tous les raccordements électriques avant d'installer l'appareil.

- Assurez-vous de raccorder de nouveau la mise à la masse de cet appareil au châssis de la voiture après l'installation.

### Remarques:

- Remplacer le fusible par un de la valeur précisée. Si le fusible saute souvent, consultez votre revendeur d'autoradios JVC.
- Si du bruit se produit...  
Cet appareil intègre un filtre anti-bruit dans le circuit d'alimentation. Cependant, avec certains véhicules, un clic ou un autre bruit gênant peut se produire. Si cela se produit, connectez la prise de mise à la masse située à l'arrière de l'appareil au châssis de la voiture en utilisant un cordon court et épais, tel qu'une tresse en cuivre ou un fil de calibre. Si le bruit persiste, consultez votre revendeur autoradio JVC.
- Il est recommandé de connecter des enceintes avec une puissance de plus de 50 W (les enceintes arrière et les enceintes avant, avec une impédance comprise entre 4 Ω et 8 Ω). Si la puissance maximum est inférieure à 50 W, changez "AMP GAIN" pour éviter d'endommager vos enceintes (voir page 22 du MANUAL D'INSTRUCTIONS).
- Le dissipateur de chaleur devient très chaud après usage. Faire attention de ne pas le toucher en retirant cet appareil.



**A Typical connections / Conexiones típicas / Raccordements typiques**

**Before connecting:** Check the wiring in the vehicle carefully. Incorrect connection may cause serious damage to this unit. The leads of the power cord and those of the connector from the car body may be different in color.

- 1 Connect the colored leads of the power cord in the order specified in the illustration below.
- 2 Connect the antenna cord.
- 3 Finally connect the wiring harness to the unit.

**Antes de la conexión:** Verifique atentamente el conexionado del vehículo. Una conexión incorrecta podría producir daños graves en la unidad. Los cordones del cable de alimentación y los del conector procedentes de la carrocería del automóvil podrían ser de diferentes en color.

- 1 Conecte los conductores de color del cable de alimentación en el orden especificado en la ilustración de abajo.
- 2 Conecte el cable de antena.
- 3 Por último, conecte el cable de alimentación a la unidad.

**Avant de commencer la connexion:** Vérifiez attentivement le câblage du véhicule. Une connexion incorrecte peut endommager sérieusement l'appareil. Le fil du cordon d'alimentation et ceux des connecteurs du châssis de la voiture peuvent être différents en couleur.

- 1 Connectez les fils colorés du cordon d'alimentation dans l'ordre spécifié sur l'illustration ci-dessous.
- 2 Connectez le cordon d'antenne.
- 3 Finalement, connectez le faisceau de fils à l'appareil.

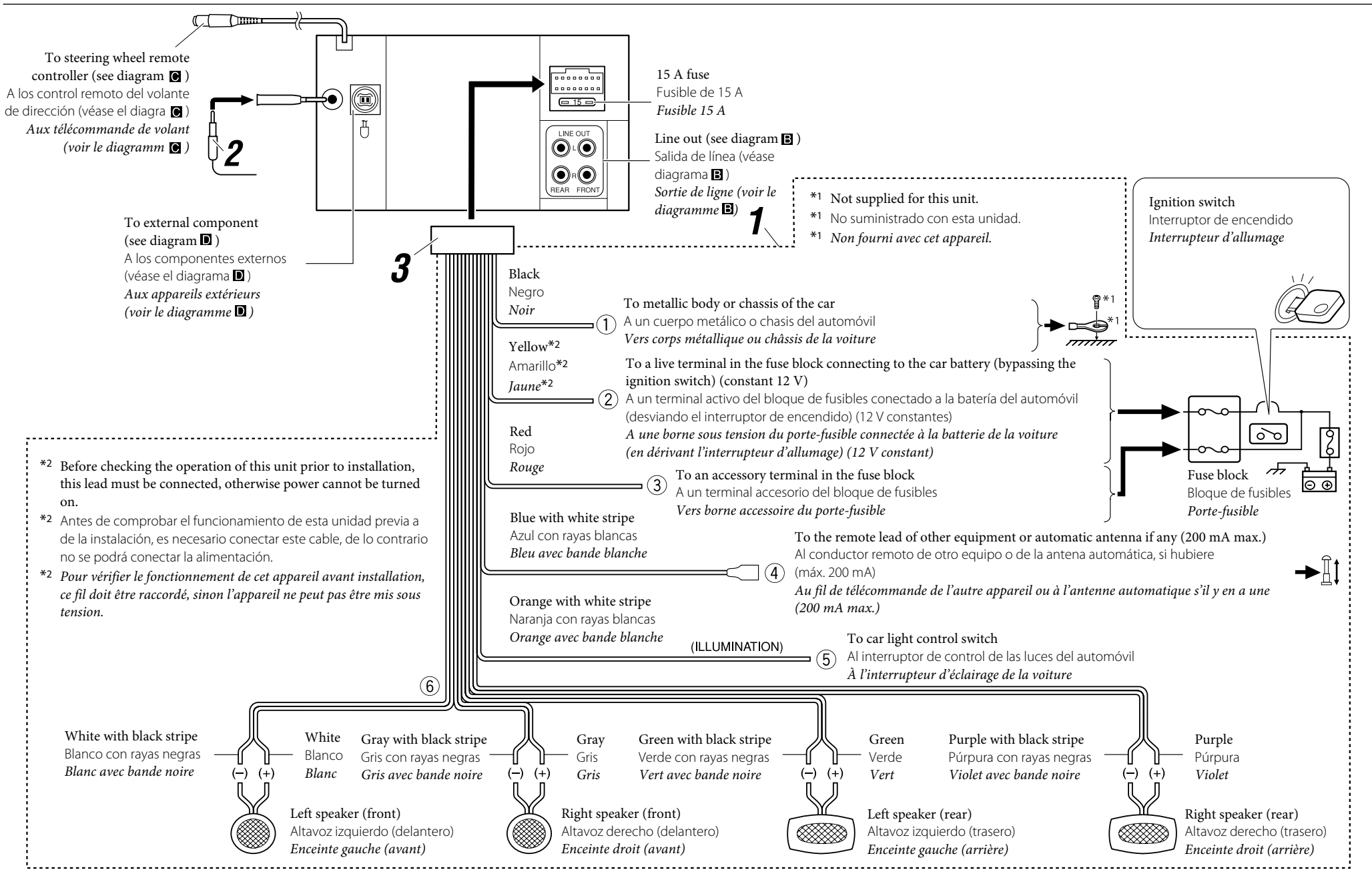

**B Connecting the external amplifier / Conexión al amplificador externo / Connexion d'un amplificateur extérieur**

You can connect amplifiers to upgrade your car stereo system.

- Connect the remote lead (blue with white stripe) to the remote lead of the other equipment so that it can be controlled through this unit.
- **Disconnect the speakers from this unit, connect them to the amplifier. Leave the speaker leads of this unit unused.**

Usted podrá conectar amplificadores para mejorar el sistema estereo de su automóvil.

- Conecte el conductor remoto (azul con rayas blancas) al conductor remoto del otro equipo para poderlo controlar a través de esta unidad.
- **Desconecte los altavoces de esta unidad y conéctelos al amplificador. Los cables de los altavoces de esta unidad quedan sin usar.**

Vous pouvez connecter des amplificateurs pour améliorer votre système autoradio.

- Connectez le fil de commande à distance (bleu avec bande blanche) au fil de commande à distance de l'autre appareil de façon qu'il puisse être commandé via cet appareil.
- **Déconnectez les enceintes de cet appareil et connectez-les à l'amplificateur. Laissez les fils d'enceintes de cet appareil inutilisés.**

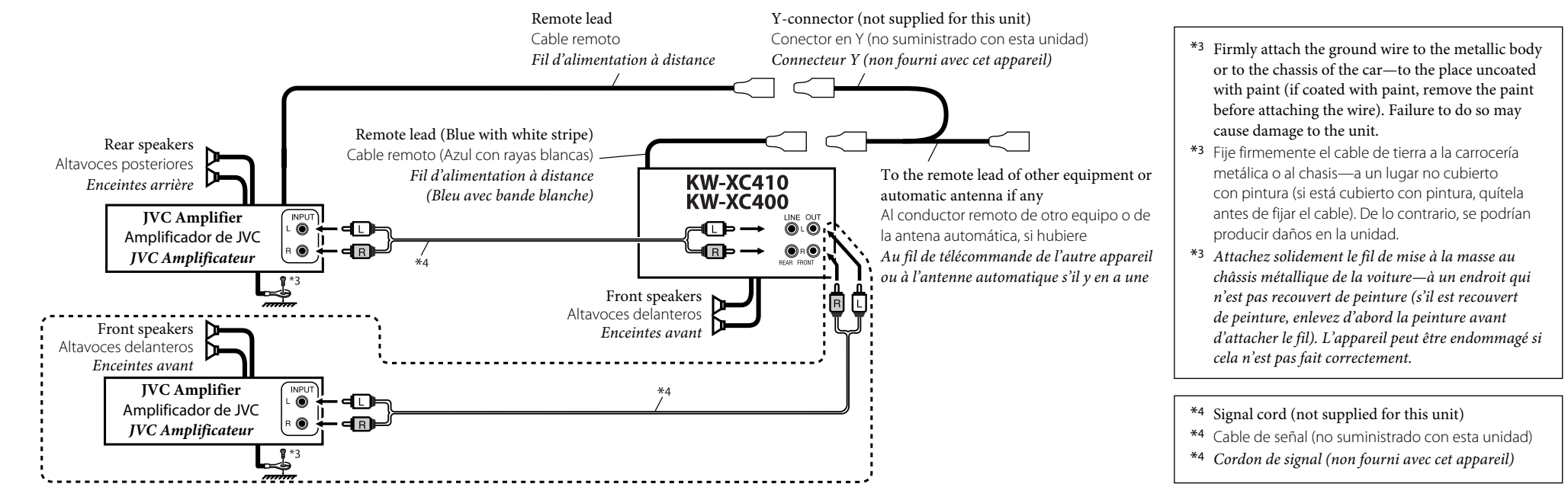

**C Connecting to the steering wheel remote controller / Conexión al control remoto del volante de dirección / Connexion de la télécommande de volant**

If your car is equipped with the steering wheel remote controller, you can operate this unit using the controller. To do it, a JVC's OE remote adapter (not supplied) which matches with your car is required. Consult your JVC car audio dealer for details.

Si su vehículo está equipado con control remoto en el volante de dirección, podrá hacer funcionar este receptor utilizando dicho control. Para ello, se requiere un adaptador para control remoto OE de JVC (no suministrado) que corresponda con su vehículo. Para mayor información, consulte con su concesionario car audio de JVC.

Si votre voiture est munie d'une télécommande de volant, vous pouvez commander cet autoradio en utilisant la télécommande. Pour le faire, un adaptateur pour télécommande au volant JVC (non fourni) correspondant à votre voiture est nécessaire. Consultez votre revendeur d'autoradio JVC pour les détails.

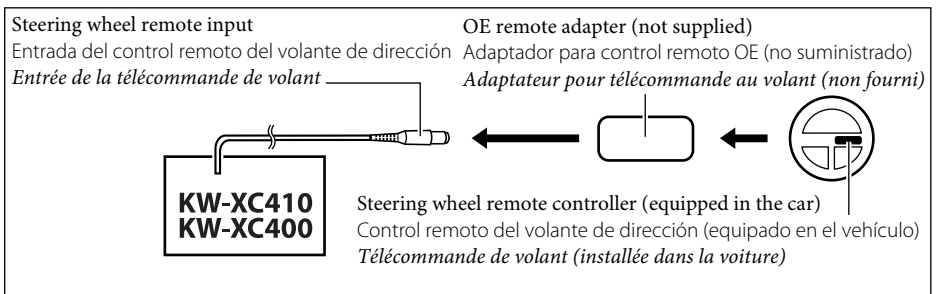

## D Connecting other external components / Conexión de otros componentes externos / Connexion d'un autre appareil extérieur

• Set "EXT INPUT" to "CHANGER" (See page 22 of the INSTRUCTIONS.) / Ajuste "EXT INPUT" a "CHANGER" (Consulte la página 22 del MANUAL DE INSTRUCCIONES.) / Réglez "EXT INPUT" sur "CHANGER" (Voir la page 22 du MANUEL D'INSTRUCTIONS.)

### JVC CD changer, SIRIUS Satellite radio, XM Satellite radio, Apple iPod®, or JVC D. player / Cambiador de CD de JVC, radio satelital SIRIUS, radio satelital XM, iPod® de Apple o reproductor JVC D. / Changeur de CD JVC, radio satellite SIRIUS, radio satellite XM, iPod® Apple ou lecteur D. JVC

You can connect these components in series as illustrated below.

- For listening to the SIRIUS Satellite radio, connect a JVC DLP —Down Link Processor (separately purchased) to this unit.
- The iPod\*5 or D. player can be connected using an interface adapter (not supplied)—KS-PD100 (for iPod) or KS-PD500 (for D. player).

Estos componentes se pueden conectar en serie, tal como se muestra en la ilustración de abajo.

- Para escuchar la radio satelital SIRIUS, conecte un DLP (Down Link Processor) de JVC (adquirido por separado) al receptor.
- Puede conectar el iPod\*5 o el reproductor D. usando un adaptador de interfaz (no suministrado)—KS-PD100 (para iPod) o KS-PD500 (para el reproductor D.).

Vous pouvez connecter ces appareils en série comme montrée sur l'illustration.

- Pour écouter la radio satellite SIRIUS, connectez un processeur DLP JVC —Processeur de signaux satellite-terre (vendu séparément) à cet appareil.
- Le iPod\*5 ou le lecteur D. peut être connecté en utilisant un adaptateur d'interface (non fourni)—KS-PD100 (pour iPod) ou KS-PD500 (pour le lecteur D.).

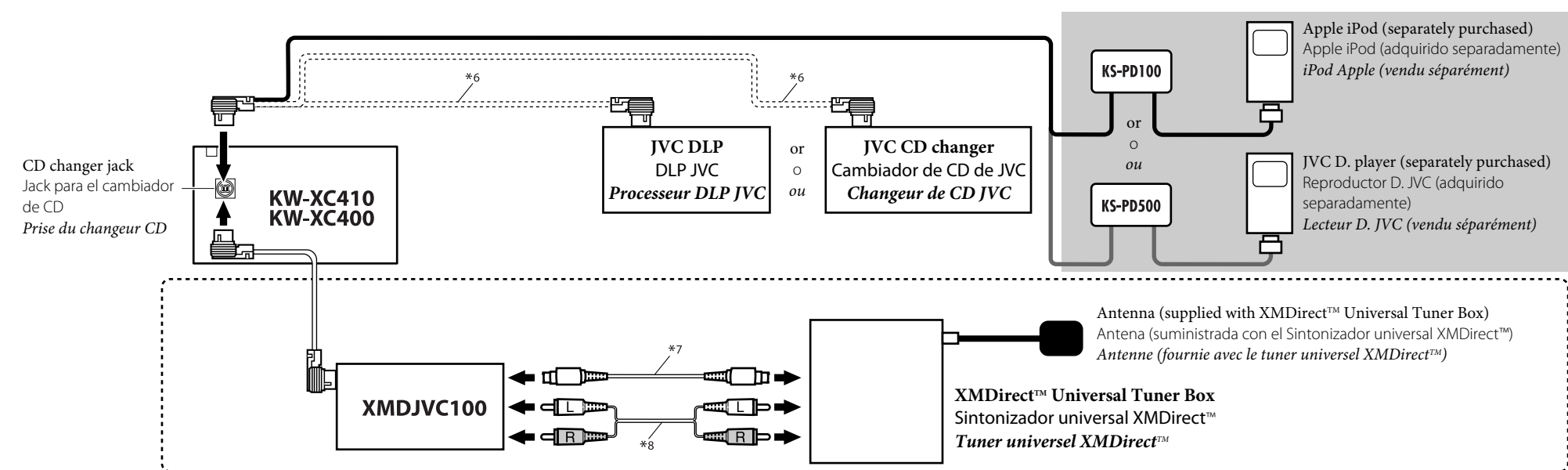
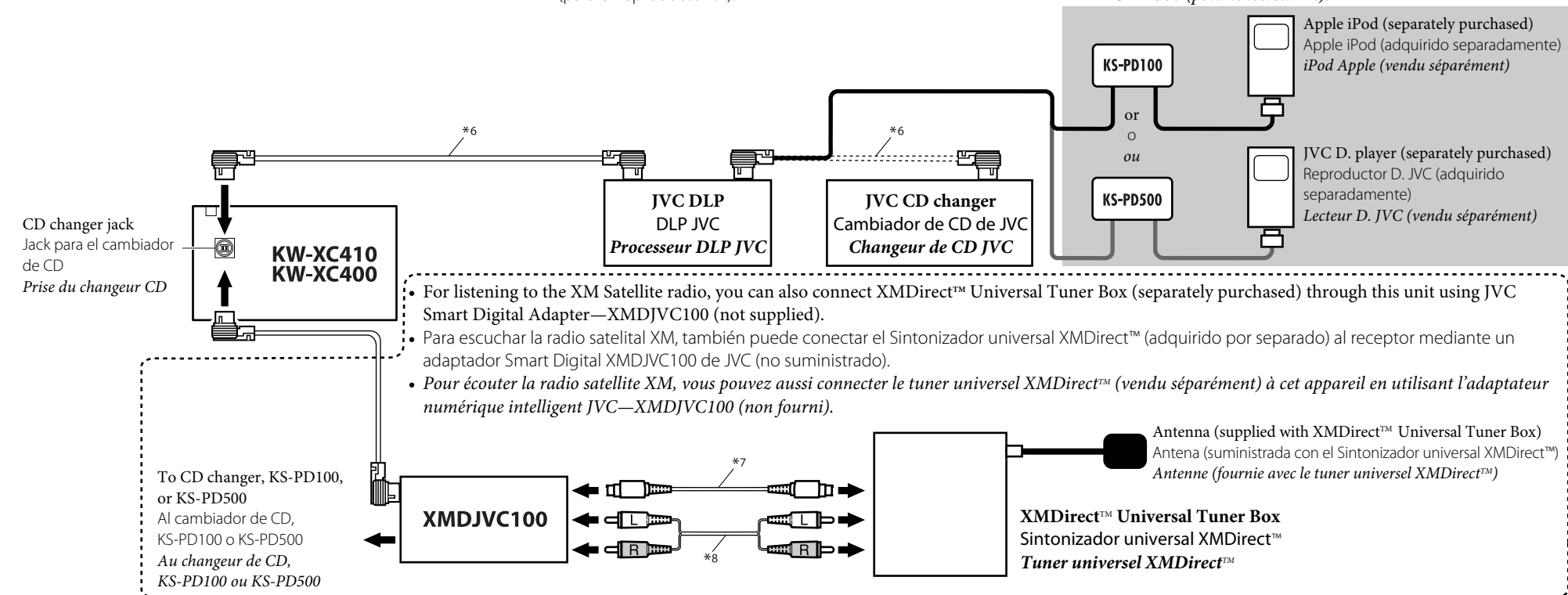

#### CAUTION / PRECAUCION / PRECAUTION:

- Before connecting the external components, make sure that the unit is turned off.
- Antes de conectar los componentes externos, asegúrese de que la unidad esté apagada.
- Avant de connecter les appareils extérieurs, assurez-vous que l'appareil est hors tension.

- \*5 iPod is a trademark of Apple Computer, Inc., registered in the U.S. and other countries.  
\*5 iPod es una marca comercial de Apple Computer, Inc., registrada en los EE.UU. y otros países.  
\*5 iPod est une marque de commerce d'Apple Computer, Inc., enregistrée aux États-Unis et dans les autres pays.

- \*6 Signal cord supplied with your JVC CD changer or DLP  
\*6 Cable de señal suministrado con su cambiador de CD o DLP JVC  
\*6 Cordon de signal fourni avec votre changeur de CD ou processeur DLP JVC

- \*7 Signal cord supplied with your Smart Digital Adapter  
\*7 Cable de señal suministrado con el adaptador Smart Digital  
\*7 Cordon de signal fourni avec votre adaptateur numérique intelligent

- \*8 Audio signal cord supplied with your Smart Digital Adapter  
\*8 Cable de señal de audio suministrado con el adaptador Smart Digital  
\*8 Cordon audio fourni avec votre adaptateur numérique intelligent

• Set "EXT INPUT" to "EXT INPUT" (See page 22 of the INSTRUCTIONS.) / Ajuste "EXT INPUT" a "EXT INPUT" (Consulte la página 22 del MANUAL DE INSTRUCCIONES.) / Réglez "EXT INPUT" sur "EXT INPUT" (Voir la page 22 du MANUEL D'INSTRUCTIONS.)

### JVC PnP (Plug and Play) / PnP ("Plug and Play") JVC / PnP ("Plug and Play") JVC

You can also connect JVC PnP through this unit using JVC SIRIUS radio adapter, KS-U100K (not supplied).

- Turning on/off the unit can also turns on/off the JVC PnP.
- También podrá conectar la PnP JVC a través de este receptor utilizando el adaptador para radio SIRIUS JVC, KS-U100K (no suministrado).
- Al encender/apagar el receptor también se enciende/apaga la PnP JVC.
- Vous pouvez aussi connecter le PnP JVC à cet autoradio en utilisant l'adaptateur de radio SIRIUS JVC KS-U100K (non fourni).
- Mettre sous/hors tension l'autoradio peut aussi mettre sous/hors tension le PnP JVC.

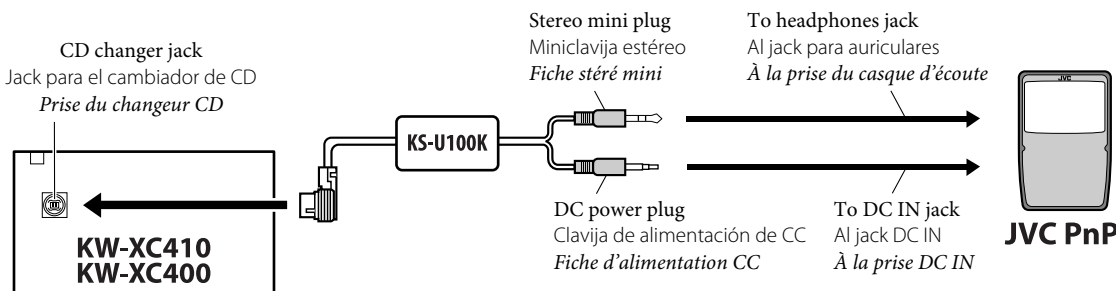

### Other external component / Otro componente externo / Autre appareil extérieur

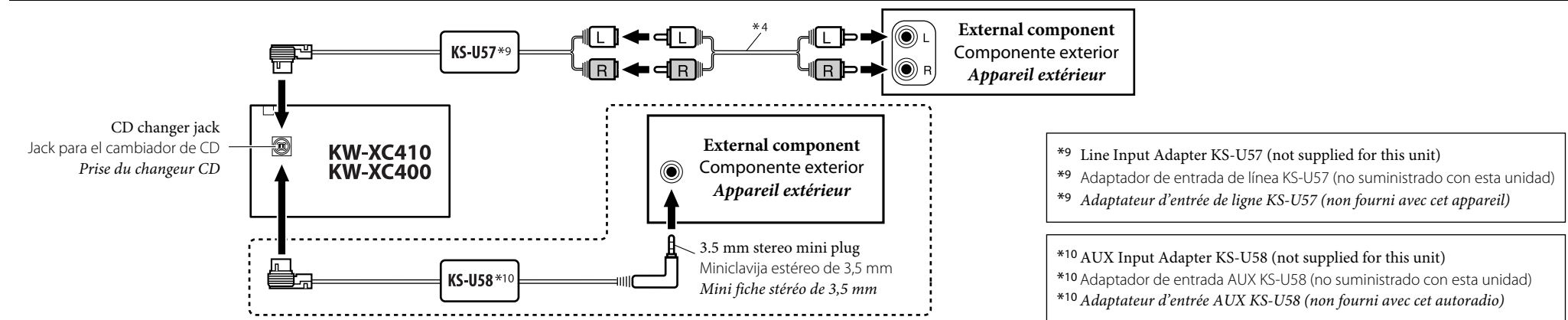

# JVC



ENGLISH

РУССКИЙ

## CD/CASSETTE RECEIVER ПРИЕМНИК С ПРОИГРЫВАТЕЛЕМ КОМПАКТ-ДИСКОВ И КАССЕТ

# KW-XC407

WMA  
MP3

COMPACT  
disc  
DIGITAL AUDIO  
TEXT

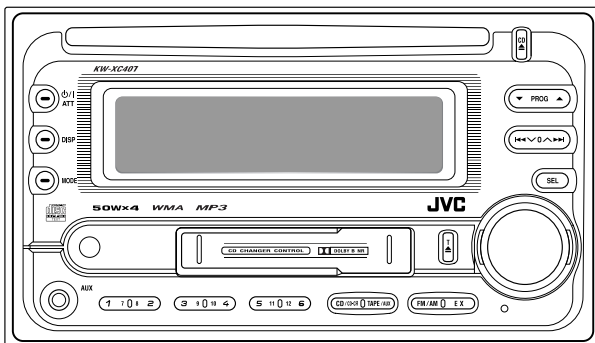
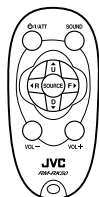

В соответствии с Законом Российской Федерации “О защите прав потребителей” срок службы (годности) данного товара “по истечении которого он может представлять опасность для жизни, здоровья потребителя, причинять вред его имуществу или окружающей среде” составляет семь (7) лет со дня производства. Этот срок является временем, в течение которого потребитель данного товара может безопасно им пользоваться при условии соблюдения инструкции по эксплуатации данного товара, проводя необходимое обслуживание, включающее замену расходных материалов и/или соответствующее ремонтное обеспечение в специализированном сервисном центре.

Дополнительные косметические материалы к данному товару, поставляемые вместе с ним, могут храниться в течение двух (2) лет со дня его производства.

Срок службы (годности), кроме срока хранения дополнительных косметических материалов, упомянутых в предыдущих двух пунктах, не затрагивает никаких других прав потребителя, в частности, гарантийного свидетельства JVC, которое он может получить в соответствии с законом о правах потребителя или других законов, связанных с ним.

For canceling the display demonstration, see page 8.

Информацию об отмене демонстрации функций дисплея см. на стр. 8.

For installation and connections, refer to the separate manual.

Указания по установке и выполнению соединений приводятся в отдельной инструкции.

## INSTRUCTIONS ИНСТРУКЦИИ ПО ЭКСПЛУАТАЦИИ



GET0329-001A  
[EE]

Thank you for purchasing a JVC product.

Please read all instructions carefully before operation, to ensure your complete understanding and to obtain the best possible performance from the unit.

## IMPORTANT FOR LASER PRODUCTS

1. CLASS 1 LASER PRODUCT
2. **CAUTION:** Do not open the top cover. There are no user serviceable parts inside the unit; leave all servicing to qualified service personnel.
3. **CAUTION:** Visible and invisible laser radiation when open and interlock failed or defeated. Avoid direct exposure to beam.
4. REPRODUCTION OF LABEL: CAUTION LABEL, PLACED OUTSIDE THE UNIT.

<b>CAUTION:</b> Visible and invisible laser radiation when open and interlock failed or defeated. AVOID DIRECT EXPOSURE TO BEAM.	<b>ADVARSEL:</b> Synlig og usynlig laserstråling når maskinen er åpen eller interlocken fejler. Undgå direkte eksponering til stråling.	<b>VARNING:</b> Synlig och osynlig laserstråling när den öppnas och spärren är urkopplad. Beträkta ej strålen.	<b>VARO:</b> Avattassa ja suojalukitus ohitettuna tai viallisena olet allina näkyväille ja näkymättömälle lasersträilylle. Vältä säteen kohdistumista suoraan iiseesi. (f)
(e)	(d)	(s)	(f)

### Warning:

If you need to operate the unit while driving, be sure to look ahead carefully or you may be involved in a traffic accident.

### Caution on volume setting:

Discs produce very little noise compared with other sources. Lower the volume before playing a disc to avoid damaging the speakers by the sudden increase of the output level.

### How to reset your unit

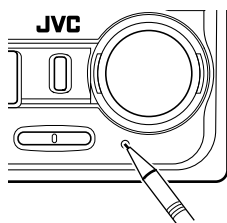

This will reset the microcomputer. Your preset adjustments will also be erased.

### How to forcibly eject a disc

If a disc cannot be recognized or cannot be ejected, eject the disc as follows.

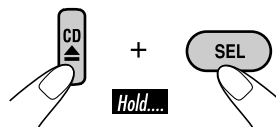

- If this does not work, reset your unit.
- Be careful not to drop the disc when it ejects.

# Contents

How to reset your unit .....	2	<b>Tape operations .....</b>	<b>17</b>
How to forcibly eject a disc .....	2	<b>Playing a tape.....</b>	<b>17</b>
How to read this manual .....	4	Finding the beginning of a tune .....	17
How to use the MODE button .....	4	Other convenient tape functions .....	17
<b>Control panel — KW-XC407.....</b>	<b>5</b>	<b>Sound adjustments .....</b>	<b>18</b>
Parts identification .....	5	<b>Selecting preset sound modes</b>	
<b>Remote controller — RM-RK50 ...</b>	<b>6</b>	<b>(EQ: equalizer).....</b>	<b>18</b>
Main elements and features .....	6	Adjusting the sound .....	18
<b>Getting started.....</b>	<b>7</b>	Storing your own sound adjustments.....	19
<b>Basic operations.....</b>	<b>7</b>	<b>General settings — PSM .....</b>	<b>20</b>
Canceling the display demonstrations ...	8	Basic procedure .....	20
Setting the clock .....	8	<b>External component operations... 22</b>	
<b>Radio operations .....</b>	<b>9</b>	<b>Playing an external component .....</b>	<b>22</b>
<b>Listening to the radio.....</b>	<b>9</b>	<b>Maintenance .....</b>	<b>23</b>
Storing stations in memory.....	9	Handling discs .....	23
Listening to a preset station .....	10	Handling cassettes .....	23
Scanning broadcast stations.....	10	<b>More about this unit.....</b>	<b>24</b>
Assigning titles to the stations .....	11	<b>Troubleshooting .....</b>	<b>27</b>
<b>Disc operations .....</b>	<b>12</b>	<b>Specifications .....</b>	<b>29</b>
<b>Playing a disc in the unit .....</b>	<b>12</b>		
<b>Playing discs in the CD changer .....</b>	<b>13</b>		
Other main functions .....	15		
Changing the display information .....	15		
Selecting the playback modes.....	16		

## For safety....

- Do not raise the volume level too much, as this will block outside sounds, making driving dangerous.
- Stop the car before performing any complicated operations.





## Temperature inside the car....

If you have parked the car for a long time in hot or cold weather, wait until the temperature in the car becomes normal before operating the unit.

## How to read this manual

The following methods are used to make the explanations simple and easy-to-understand:

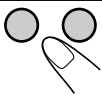
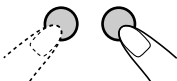
- Some related tips and notes are explained in “More about this unit” (see pages 24 – 26).
- Button operations are mainly explained with the illustrations as follows:

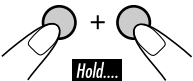
	Press briefly.
	Press repeatedly.
	Press either one.
	
	Press and hold until your desired response begins.
	Press and hold both buttons at the same time.

The following marks are used to indicate...



: Built-in CD player operations.



: External CD changer operations.

This unit is equipped with the steering wheel remote control function.

- For connection, see the Installation/Connection Manual (separate volume).

## How to use the MODE button

Press MODE repeatedly to select the different functions available during play.

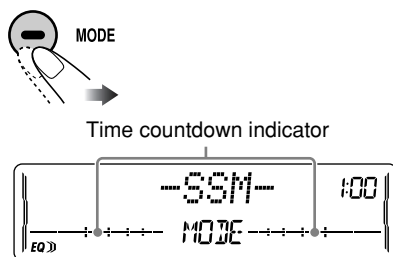

Ex.: When “SSM” is selected

### While listening to the radio:

- You cannot select “SSM” or “SCAN” if you are listening to the station stored in the EX (extra) button, see page 10 for details.

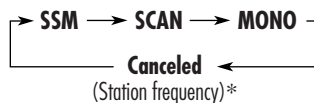

### While listening to a disc:



### While listening to a tape:



### While adjusting the sound mode:

- Pressing MODE allows you to store the adjusted sound mode into memory. (See page 19 for details.)

\* Depending on the level meter setting. (See page 20 for details.)



## Parts identification

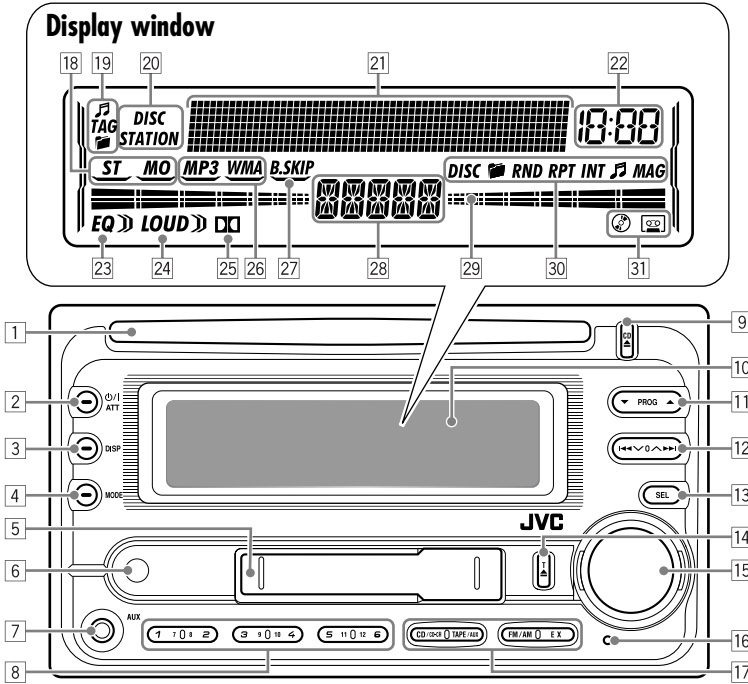

- 1 Loading slot
- 2  $\Phi$ /I ATT (standby/on attenuator) button
- 3 DISP (display) button
- 4 MODE button
- 5 Cassette compartment
- 6 Remote sensor
  - *DO NOT* expose the remote sensor to strong light (direct sunlight or artificial lighting).
- 7 AUX (auxiliary) input jack
- 8 Number buttons
- 9 CD  $\blacktriangle$  (CD eject) button
- 10 Display window
- 11  $\blacktriangle$  (up) /  $\blacktriangledown$  (down) buttons  
PROG (program)  $\blacktriangle$  /  $\blacktriangledown$  buttons
- 12  $\blacktriangle\blacktriangle\blacktriangledown$  /  $\blacktriangle\blacktriangleright\blacktriangleright$  buttons
- 13 SEL (select) button
- 14 T  $\blacktriangle$  (tape eject) button
- 15 Control dial
- 16 Reset button
- 17 Source buttons—CD/CD-CH, TAPE/AUX, FM/AM, EX (extra)

### Display window

- 18 Tuner reception indicators—ST (stereo), MO (monaural)
- 19 Disc information indicators— $\mathbb{N}$  (track/file), TAG (ID3 Tag),  $\mathbb{N}$  (folder)
- 20 Text name indicators—DISC, STATION
- 21 Main display, level meter
- 22 Clock indicator
- 23 EQ (equalizer) indicator
- 24 LOUD (loudness) indicator
- 25  $\mathbb{N}$  (Dolby B NR) indicator
- 26 Playback disc indicators—MP3, WMA
- 27 B.SKIP (blank skip) indicator
- 28 Source display
- 29 Level meter, volume meter, time countdown indicator
- 30 Playback mode indicators—DISC,  $\mathbb{N}$  (folder), RND (random), RPT (repeat), INT (intro),  $\mathbb{N}$  (track/file), MAG (magazine)
- 31 Loaded source indicators— $\mathbb{N}$  (disc),  $\mathbb{N}$  (tape)

## Installing the lithium coin battery (CR2025)

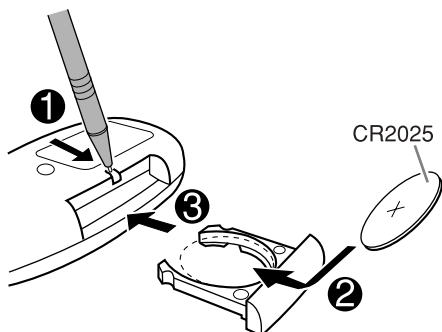

- When operating, aim the remote controller directly at the remote sensor on the unit. Make sure there is no obstacle in between.

### Warning:

- Do not install any battery other than CR2025 or its equivalent; otherwise, it may explode.
- Store the battery in a place where children cannot reach to avoid risk of accident.
- To prevent the battery from over-heating, cracking, or starting a fire:
  - Do not recharge, short, disassemble, heat the battery, or dispose of it in a fire.
  - Do not leave the battery with other metallic materials.
  - Do not poke the battery with tweezers or similar tools.
  - Wrap the battery with tape and insulate when throwing away or saving it.

### Caution:

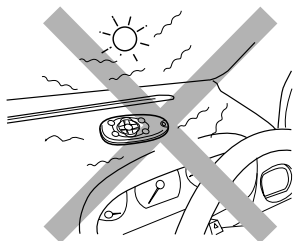

## Main elements and features

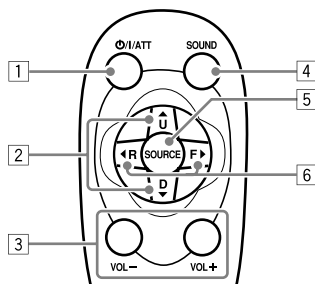

- 1** **⏻/I/ATT** (standby/on/attenuator) button
  - Turns the power on if pressed briefly or attenuates the sound when the power is on.
  - Turns the power off if pressed and held.
- 2** **▲ U** (up) / **D** (down) **▼** buttons
  - Changes the FM/AM bands with **▲ U** only.
  - Changes the preset stations with **D ▼** only.
  - Changes the folder of the MP3/WMA discs.
  - Changes the tape directions with **▲ U** only.
  - While playing an MP3 disc on an MP3-compatible CD changer:
    - Changes the disc if pressed briefly.
    - Changes the folder if pressed and held.
- 3** **VOL - / VOL +** buttons
  - Adjusts the volume level.
- 4** **SOUND** button
  - Selects the sound mode (EQ: equalizer).
- 5** **SOURCE** button
  - Selects the source.
- 6** **◀ R** (reverse) / **F** (forward) **▶** buttons
  - Searches for stations if pressed briefly.
  - Fast-forwards or reverses the track if pressed and held.
  - Changes the tracks of the disc if pressed briefly.
  - Fast-forwards or reverses the tape if pressed and held.\*
  - Finds the beginning of a tune (MMS) while listening to a tape if pressed briefly.\*

\* To release these operations, press **▲ U**. Playback resumes.

# Getting started

## Basic operations

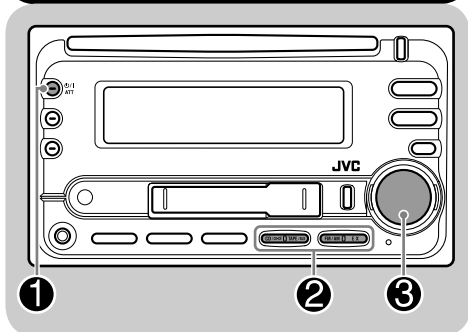

### For TAPE/AUX



\* You cannot select these sources if they are not ready.

### 3 Adjust the volume.



Volume level appears.



Volume level indicator

### 4 Adjust the sound as you want. (See pages 18 and 19.)

### 1 Turn on the power.



### 2 For FM/AM tuner

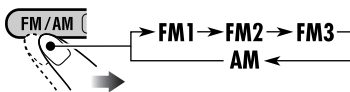

### For your favorite station



- Stored your favorite station, see page 10 for details.

### For CD/CD-CH



- Select "CD-CH" when using an Apple iPod® or a JVC D. player (see page 22).

iPod is a trademark of Apple Computer, Inc., registered in the U.S. and other countries.

### To drop the volume in a moment (ATT)



To restore the sound, press it again.

### To turn off the power



## Canceling the display demonstrations

If no operations are done for about 20 seconds, display demonstration starts.

[Initial: DEMO ON]—see page 20.

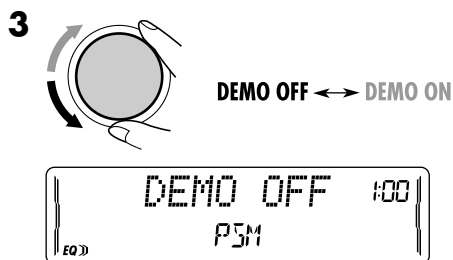
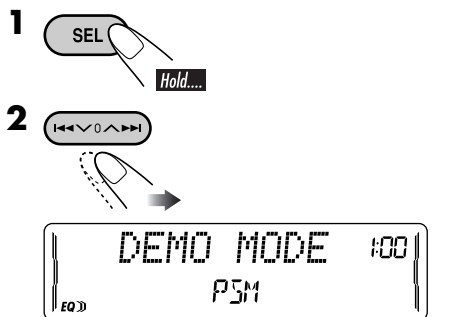

**4** Finish the procedure.



## To activate the display demonstration

In step **3** above...



## Setting the clock

- 1**
- 
- 2** Set the hour and minute.
- 1** Select “CLOCK HOUR,” then adjust the hour.
  - 2** Select “CLOCK MIN,” (minute) then adjust the minute.

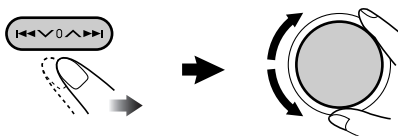

**3** Finish the procedure.



# Radio operations

## Listening to the radio

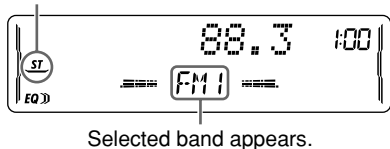
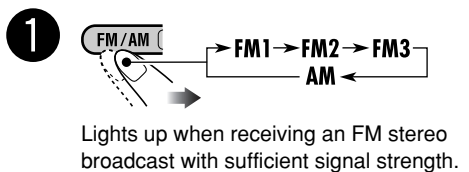
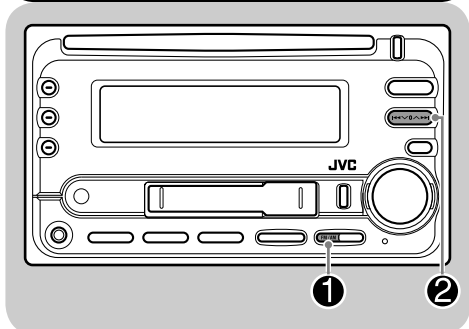

## 2 Start searching for a station.

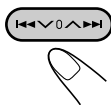

When a station is received, searching stops.  
To stop searching, press the same button again.

## To tune in to a station manually

In step 2 above...



## 2 Select the desired station frequencies.

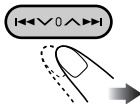

## When an FM stereo broadcast is hard to receive

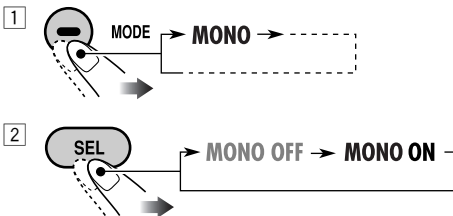

Lights up when monaural mode is activated.

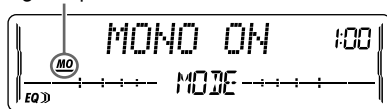

Reception improves, but stereo effect will be lost.

To restore the stereo effect, repeat the same procedure. Then, in step 2, select "MONO OFF."

## Storing stations in memory

You can preset six stations for each band.

## FM station automatic presetting—SSM (Strong-station Sequential Memory)

### 1 Select the FM band (FM1 – FM3) you want to store into.

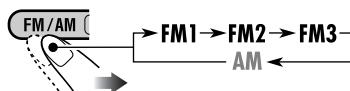

To be continued....

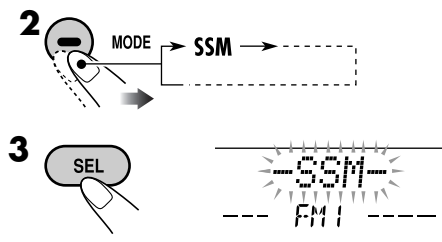

“SSM” flashes, then disappears when automatic presetting is over.

Local FM stations with the strongest signals are searched and stored automatically in the FM band.

### Manual presetting

Ex.: Storing FM station of 92.5 MHz into the preset number 4 of the FM1 band.

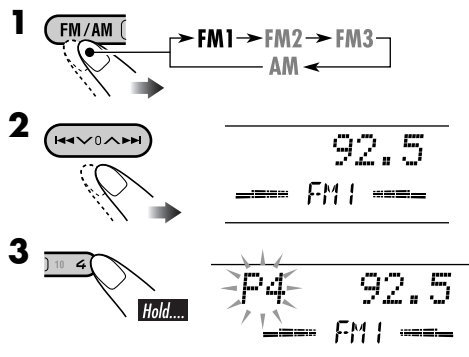

Preset number flashes for a while.

### Storing your favorite station into the EX (extra) button

Ex.: Storing your favorite FM station of 92.5 MHz into the EX button

While listening to an FM station, tune in to your favorite station, then...

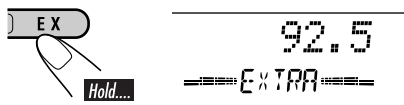

### Listening to a preset station

- Press the FM/AM button to select the FM band. The display shows FM1, FM2, FM3, and AM.
- Select the preset station (1 – 6) you want.

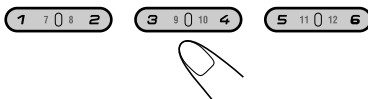

or

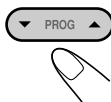

### To tune in to your favorite station (EX)

If you press the button again, the previous source will be played back again.

### Scanning broadcast stations

- Press the MODE button to start scanning. The display shows 'SCAN 92.55' and 'FM1'.
- Start scanning.

Each time a broadcast is tuned in, scanning stops for about 5 seconds (tuned frequency appears on the display), and you can check what program is now being broadcast.

- Start listening to the program.

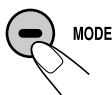

## Assigning titles to the stations

You can assign titles to 30 station frequencies (including both FM and AM). Each station name can be assigned up to 10 characters. However, you cannot assign title to the station frequency stored in the EX button.

**1** Tune in to the station you would like to assign a title to.

**2** Enter the assigning mode.

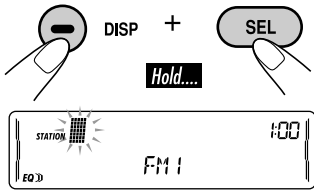

**3** Assign a title.

**1** Select a character set.

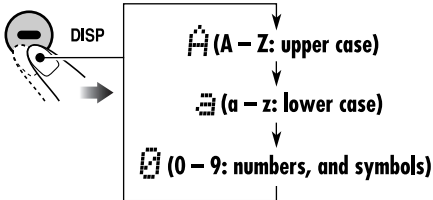

**2** Select a character.

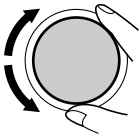

**3** Move to the next (or previous) character position.

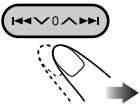

**4** Repeat steps **1** to **3** until you finish entering the title.

**4** Finish the procedure.



**To erase the entire title**

In step **3** on the left...

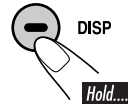

**To change the information shown on the display**

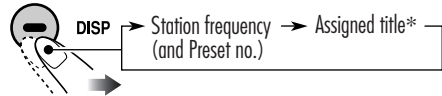

\* If no title is assigned, "NO NAME" appears for a while.

### Available characters

Upper case

A	B	C	D	E	F	G	H	I	J	K	L	M	N
O	P	Q	R	S	T	U	V	W	X	Y	Z	space	

Lower case

a	b	c	d	e	f	g	h	i	j	k	l	m	n
o	p	q	r	s	t	u	v	w	x	y	z	space	

Numbers and symbols

0	1	2	3	4	5	6	7	8	9	!	"	#	\$
%	&	'	(	)	*	+	,	-	.	/	:	;	<
=	>	?	@	_	`	space							

# Disc operations

## Playing a disc in the unit

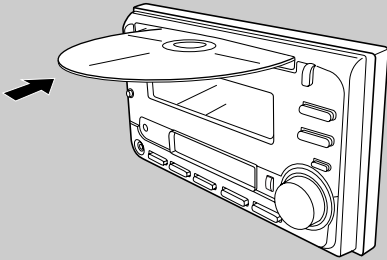

All tracks will be played repeatedly until you change the source or eject the disc.

- When inserting an MP3 or a WMA disc:



Total folder number      Total file number

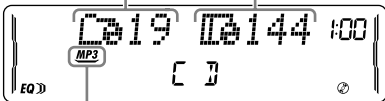

\*1

**Disc information appears automatically (see page 15).**

Current track number\*2      Elapsed playing time\*2

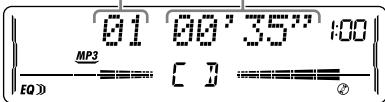

- When inserting an audio CD or a CD Text disc:

Total track number of the inserted disc      Total playing time of the inserted disc

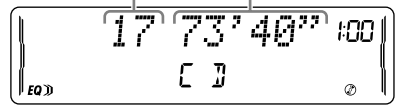

**CD Text: Disc title/performer → Track title appears automatically (see page 15).**

Current track number\*2      Elapsed playing time\*2

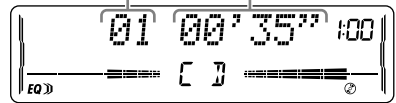

## To stop play and eject the disc



The source changes to the last selected source.

\*1 Either the MP3 or WMA indicator lights up depending on the detected file.

\*2 Depending on the level meter setting. (See page 20 for details.)



## Playing discs in the CD changer

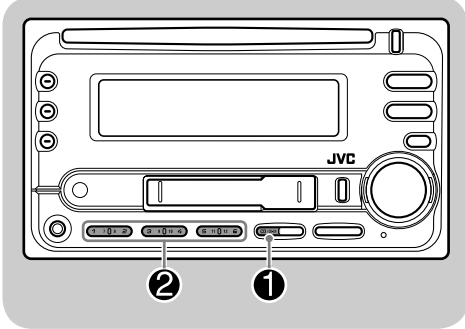

All tracks of the inserted discs in the magazine will be played repeatedly until you change the source or eject the magazine from the CD changer.

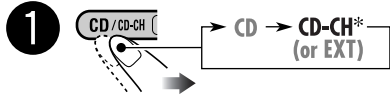

\* If you have changed "EXT INPUT" setting to "EXT INPUT" (see page 21), you cannot select the CD changer.

See also page 22 for using iPod or JVC D. player.

### About the CD changer

It is recommended to use a JVC MP3-compatible CD changer with your unit.

- You can also connect other CH-X series CD changers (except CH-X99 and CH-X100). However, they are not compatible with MP3 discs, so you cannot play back MP3 discs.
- You cannot play any WMA disc in the CD changer.
- You cannot use the KD-MK series CD changers with this unit.
- Disc text information recorded in the CD Text can be displayed when a JVC CD Text compatible CD changer is connected.

### 2 Select a disc.

For disc number from 01 – 06:

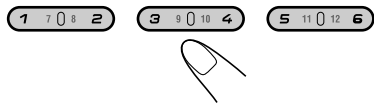

For disc number from 07 – 12:

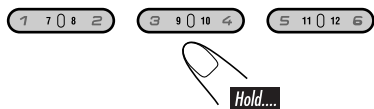

For connection, see Installation/Connection Manual (separate volume).

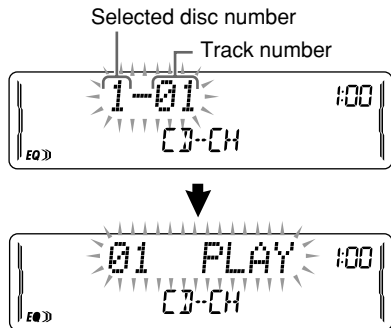

- When the current disc is an MP3 disc:

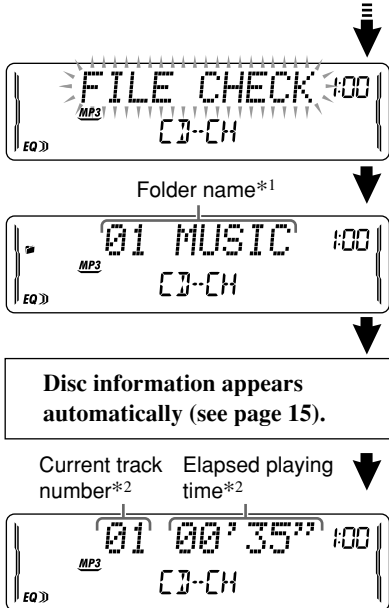

- When the current disc is an audio CD or a CD Text disc:

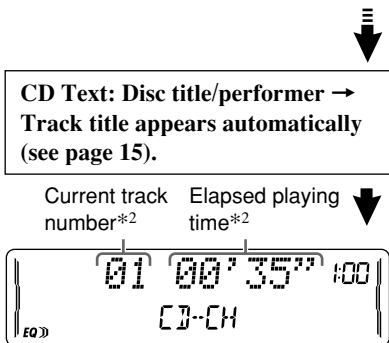

\*1 "ROOT" appears if no folder is included in the disc.  
 \*2 Depending on the level meter setting. (See page 20 for details.)

### To fast-forward or reverse the track

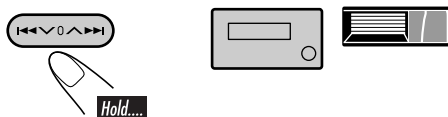

### To go to the next or previous tracks

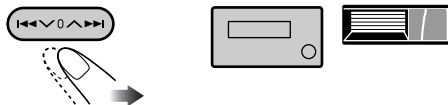

### To go to the next or previous folders (for MP3 and WMA discs)

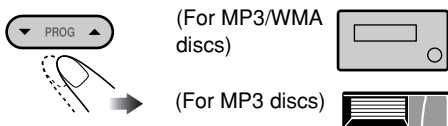

### To locate a particular track (for CD) or folder (for MP3 or WMA discs) directly

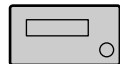

To select a number from 01 – 06:



To select a number from 07 – 12:

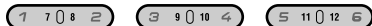

- To use folder search on MP3/WMA discs, it is required that folders are assigned with 2-digit numbers at the beginning of their folder names—01, 02, 03, and so on.

To select a particular track in a folder (for MP3 or WMA disc):

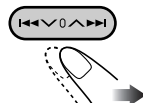

## Other main functions

### ■ Skipping a track quickly during play



 Only possible on JVC MP3-compatible CD changer

- For MP3 or WMA disc, you can skip a track within the same folder.

Ex.: To select track 32 while playing track 6

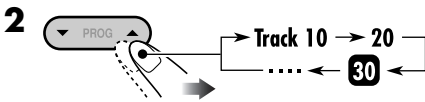
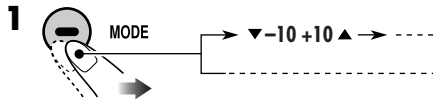

First time you press ▲ / ▼ button, the track skips to the nearest higher or lower track with a track number of multiple ten (ex. 10th, 20th, 30th).

Then each time you press the button, you can skip 10 tracks.

- After the last track, the first track will be selected and vice versa.

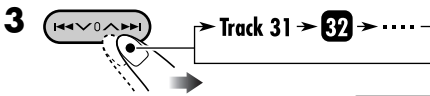

### ■ Prohibiting disc ejection



You can lock a disc in the loading slot.

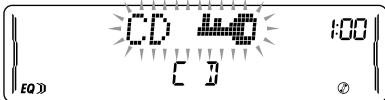
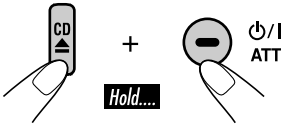

To cancel the prohibition, repeat the same procedure.

## Changing the display information

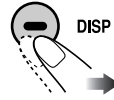

### ■ While playing an audio CD or a CD Text



### ■ While playing an MP3 or WMA disc

- When “TAG DISP” is set to “TAG ON” (see page 21)

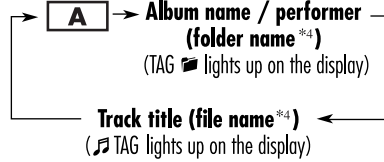

- When “TAG DISP” is set to “TAG OFF”

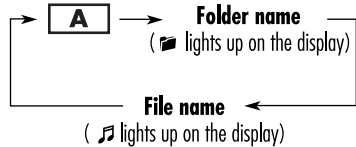

**A** : Current track/file number and Elapsed playing time

\*3 If the current disc is an audio CD, “NO NAME” appears.

\*4 If an MP3/WMA file does not have ID3 tags, folder name and file name appear. In this case, the TAG indicator will not light up.

## Selecting the playback modes

You can use only one of the following playback modes at a time.

Select your desired playback mode.

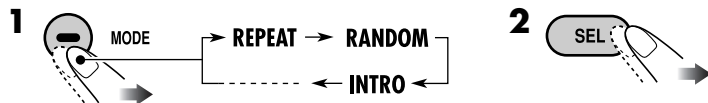

### Repeat play

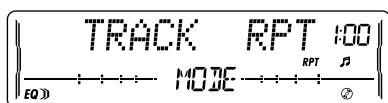

Ex.: When "TRACK RPT" is selected

### Mode

### Plays repeatedly

- TRACK RPT** : The current track.  
• RPT and light up.
- FOLDER RPT\*1** : All tracks of the current folder.  
• and RPT light up.
- DISC RPT\*2** : All tracks of the current disc.  
• DISC and RPT light up.
- REPEAT OFF** : Cancels.

### Random play

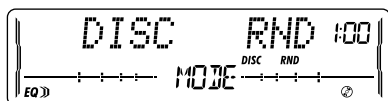

Ex.: When "DISC RND" is selected

### Mode

### Plays at random

- FOLDER RND\*1** : All tracks of the current folder, then tracks of the next folder and so on.  
• and RND light up.
- DISC RND** : All tracks of the current disc.  
• DISC and RND light up.
- MAG RND\*2** : All tracks of the inserted discs.  
• RND and MAG light up.
- RANDOM OFF** : Cancels.

### Intro scan

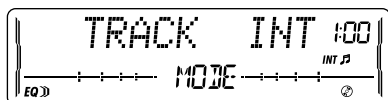

Ex.: When "TRACK INT" is selected

### Mode

### Plays the beginning 15 seconds of...

- TRACK INT** : All tracks of the current disc.  
• INT and light up.
- FOLDER INT\*1** : The first track of every folder of the current disc.  
• and INT light up.
- DISC INT\*2** : The first tracks of the inserted discs.  
• DISC and INT light up.
- INTRO OFF** : Cancels.

\*1 Only while playing an MP3 disc or WMA disc.

\*2 Only while playing discs in the CD changer.

# Tape operations

## Playing a tape

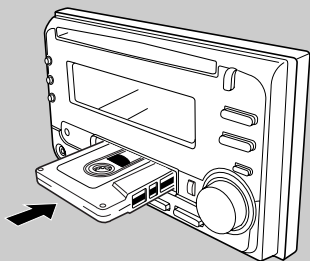

Playback starts automatically. When one side of the tape reaches its end during play, the other side of the tape automatically starts playing. (Auto Reverse)

## Finding the beginning of a tune

Multi Music Scan (MMS) allows you to automatically start playback from the beginning of a specified tune.

Specify the tune you want to locate (how many tunes ahead of or before the current tune)

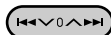

When the beginning of the specified tune is located, playback starts automatically.

**MMS -9** ↔ **MMS -1**\*3, **MMS +1** ↔ **MMS +9**

\*3 Goes back to the beginning of the current tune.

## To change the playback direction

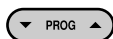

## To stop play and eject the cassette



The source changes to the last selected source.

## To fast-forward or rewind a tape

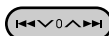

When the tape reaches its end while fast-forwarding, the tape direction will change automatically.

To stop fast-forwarding or rewinding, press the PROG button.

## Prohibiting tape ejection

You can lock a tape in the loading slot.



To cancel the prohibition, repeat the same procedure.

## Other convenient tape functions



- To turn on or off Dolby B NR\*4

**DOLBY ON** ↔ **DOLBY OFF**  
( lights up on the display)

- To skip blank portions on the tape

**B.SKIP ON** ↔ **B.SKIP OFF**  
(**B.SKIP** lights up on the display)

- To play the current tune repeatedly

**REPEAT ON** ↔ **REPEAT OFF**  
(**RPT** lights up on the display)

\*4 Manufactured under license from Dolby Laboratories. "Dolby" and the double-D symbol are trademarks of Dolby Laboratories.

# Sound adjustments

## Selecting preset sound modes

(EQ: equalizer)

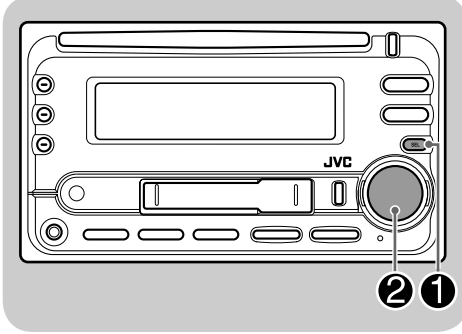

You can select a preset sound mode suitable to the music genre.

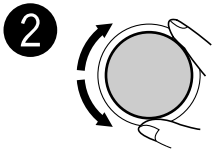
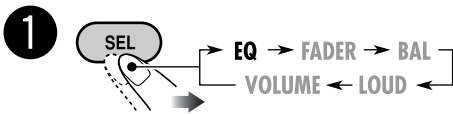

- FLAT** ⇄ **Hard Rock** ⇄ **R & B** ⇄  
**POP** ⇄ **JAZZ** ⇄ **DanceMusic** ⇄  
**Country** ⇄ **Reggae** ⇄ **Classic** ⇄  
**USER 1** ⇄ **USER 2** ⇄ **USER 3** ⇄  
 (back to the beginning)

### To select the sound mode directly

You can select the sound mode directly using the remote controller.

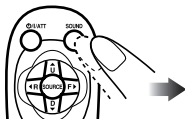

## Adjusting the sound

You can adjust the sound characteristics to your preference.

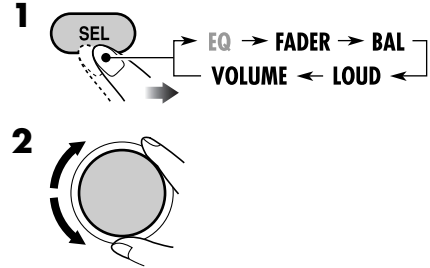

Indication	Range
<b>FADER</b> *1 Adjust the front and rear speaker balance.	R06 (Rear only) to F06 (Front only)
<b>BAL</b> (balance) Adjust the left and right speaker balance.	L06 (Left only) to R06 (Right only)
<b>LOUD</b> (loudness) Boost low and high frequencies to produce a well-balanced sound at low volume level.	LOUD ON ↑ LOUD OFF
<b>VOLUME</b> *2 Adjust the volume.	00 (min.) to 30 or 50 (max.)*3

\*1 If you are using a two-speaker system, set the fader level to "00."

\*2 Normally the control dial works as the volume control. So you do not have to select "VOLUME" to adjust the volume level.

\*3 Depending on the amplifier gain control setting. (See page 21 for details.)

## Storing your own sound adjustments

You can adjust the sound modes and store your own adjustments in memory.

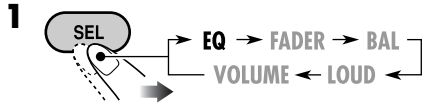

**2** Select one of the sound mode to adjust.

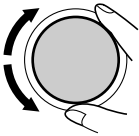

Ex.: When "JAZZ" is selected

**3** Select the sound elements to adjust while the selected sound mode is shown.

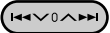

LOW LEVEL ⇄ LOW FREQ. ⇄  
 LOW WIDTH ⇄ MID LEVEL ⇄  
 MID WIDTH ⇄ HIGH LEVEL ⇄  
 HIGH FREQ. ⇄ (back to the beginning)

- **(LOW, MID, HIGH) LEVEL:**  
Adjust the enhancement level.
- **(LOW, HIGH) FREQ:**  
Select the center frequency to adjust.
- **(LOW, MID) WIDTH :**  
Select the band width level.

**4** Adjust the selected sound elements while the indication on step 3 is shown.



Indication	Preset values		
	LOW	MID	HIGH
LEVEL	-06 (min.) to +06 (max.)	-06 (min.) to +06 (max.)	-06 (min.) to +06 (max.)
FREQ	60Hz 80Hz 100Hz 120Hz	—	8kHz 10kHz 12kHz 15kHz
WIDTH	1 (min.) to 4 (max.)	1 (min.) to 2 (max.)	—

**5** Repeat steps 3 and 4 to set (or adjust) the other sound elements.

**6** Select one of the user sound modes (USER 1, USER 2, USER 3).

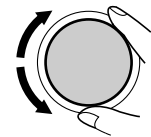
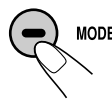

**7** Store the adjustments.

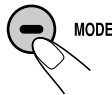

"MEMORY" appears for a while.

# General settings — PSM

## Basic procedure

You can change PSM (Preferred Setting Mode) items listed in the table that follows.



**2** Select a PSM item.

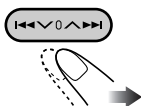

**3** Adjust the PSM item selected.

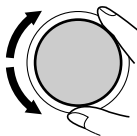

**4** Repeat steps 2 and 3 to adjust the other PSM items if necessary.

**5** Finish the procedure.



Indications	Selectable settings, [reference page]
<b>DEMO MODE</b> Display demonstration	<b>DEMO ON</b> : [Initial]; Display demonstration will be activated automatically if no operation is done for about 20 seconds, [8]. <b>DEMO OFF</b> : Cancels.
<b>CLOCK HOUR</b> Hour adjustment	1 – 12, [8] [Initial: 1 (1:00)]
<b>CLOCK MIN</b> Minute adjustment	00 – 59, [8] [Initial: 00 (1:00)]
<b>CLOCK DISP</b> Clock display	<b>CLOCK ON</b> : Clock time is shown on the display at all times even when the unit is turned off. <b>CLOCK OFF</b> : [Initial]; Clock time is shown when the unit is turned on. If the unit is turned off, pressing DISP will show the clock time for about 5 seconds.

**LEVELMETER**  
Audio level meter

You can select one of the four different level meter patterns or a demonstration of all the patterns.

**LEVEL ALL** [Initial] ⇄ **LEVEL 1** ⇄ **LEVEL 2** ⇄ **LEVEL 3** ⇄ **LEVEL 4** ⇄ **LEVEL OFF** (canceled) ⇄ (back to the beginning)

**LEVEL ALL** : Demonstrates all the level meter patterns, each for about 20 seconds.

LEVEL 1

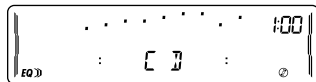

LEVEL 2

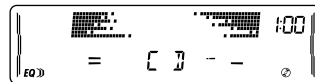

LEVEL 3

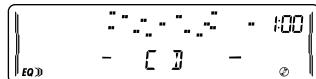

LEVEL 4

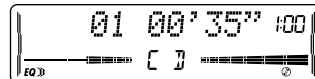



Indications	Selectable settings, [reference page]
<b>DIMMER</b> Dimmer	<b>AUTO</b> : [Initial]; Dims the display when you turn on the headlights.
	<b>ON</b> : Activates dimmer.
	<b>OFF</b> : Cancels.
<b>CONTRAST</b> Display contrast	<b>1 – 10</b> : Adjust the display contrast to make the display indications clear and legible. [Initial: 5]
<b>TEL</b> Telephone muting	<b>MUTING1/MUTING2:</b> Select either one which mutes the sounds while using the cellular phone. <b>OFF:</b> [Initial]; Cancels.
<b>SCROLL</b> *1 Scroll	<b>ONCE</b> : [Initial]; Scrolls the disc information once.
	<b>AUTO</b> : Repeats scrolling (5-second intervals in between).
	<b>OFF</b> : Cancels. • Pressing DISP for more than one second can scroll the display regardless of the setting.
<b>EXT INPUT</b> *2 External input	<b>CHANGER</b> : [Initial]; To use a JVC CD changer [13], an Apple iPod, or a JVC D. player [22].
	<b>EXT INPUT</b> : To use another external component, [22].
<b>AUX ADJUST</b> Auxiliary input level adjustment	<b>AUX ADJ 00 – AUX ADJ 05:</b> Adjust the auxiliary input level accordingly, to avoid the sudden increase of the output level when changing the source from external component connected to the AUX input jack on the control panel. [Initial: AUX ADJ 00]
<b>TAG DISP</b> Tag display	<b>TAG ON</b> : [Initial]; Shows the ID3 tag while playing MP3/WMA tracks, [15].
	<b>TAG OFF</b> : Cancels.
<b>AMP GAIN</b> Amplifier gain control	You can change the maximum volume level of this unit.
	<b>LOW PWR</b> : VOLUME 00 – VOLUME 30 (Select this if the maximum power of the speaker is less than 50 W to avoid damaging the speaker.)
	<b>HIGH PWR</b> : [Initial]; VOLUME 00 – VOLUME 50
<b>IF FILTER</b> IF filter	<b>AUTO</b> : [Initial]; Increases the tuner selectivity to reduce noise interference between the stations. (Stereo effect will also be lost.)
	<b>WIDE</b> : Subject to noise interference from adjacent stations, but sound quality will not be degraded and will retain the stereo effect.

\*1 Some characters or symbols will not be shown correctly (or will be blanked) on the display.

\*2 Cannot be selected if the source is “CD-CH” or “EXT.”

# External component operations

This unit is ready for any Apple iPod® or JVC D. player control interface.

- For details, refer also to the manual supplied with the interface adapter for iPod®—KS-PD100 or D. player—KS-PD500.

## Playing an external component

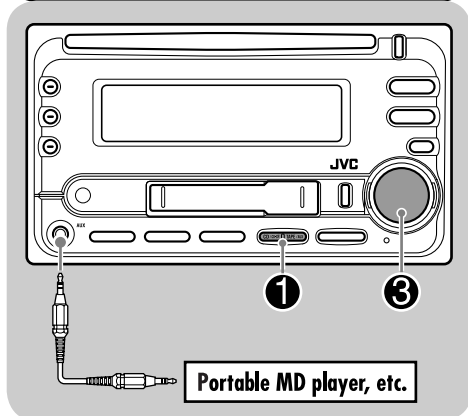

You can connect an external component to...

- CD changer jack on the rear using:
  - Line Input Adapter—KS-U57 (not supplied) or AUX Input Adapter—KS-U58 (not supplied) for any other components (except iPod or D. player).
  - Interface adapter for iPod®—KS-PD100 (not supplied) for controlling iPod.
  - D. player interface adapter—KS-PD500 (not supplied) for controlling D. player.
- AUX (auxiliary) input jack on the control panel.

For connection, see Installation/Connection Manual (separate volume).

- 1 For selecting the external component connected to...
  - AUX input jack

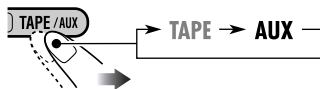

- CD changer jack on the rear using KS-U57 or KS-U58

If “EXT” does not appear, see page 21 and select the external input (EXT INPUT).

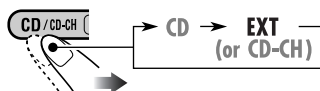

- CD changer jack on the rear using interface adapter for iPod—KS-PD100 or for D. player—KS-PD500

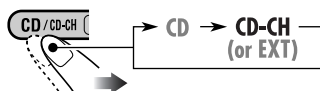

- 2 Turn on the connected component and start playing the source.
- 3 Adjust the volume.

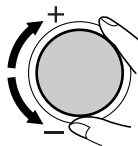

- 4 Adjust the sound as you want. (See pages 18 and 19.)

## Handling discs

### Moisture condensation

Moisture may condense on the lens inside the CD player in the following cases:

- After starting the heater in the car.
- If it becomes very humid inside the car.

Should this occur, the CD player may malfunction. In this case, eject the disc and leave the unit turned on for a few hours until the moisture evaporates.

### How to handle discs

When removing a disc from its case, press down the center holder of the case and lift the disc out, holding it by the edges.

Center holder



- Always hold the disc by the edges. Do not touch its recording surface.

When storing a disc into its case, gently insert the disc around the center holder (with the printed surface facing up).

- Make sure to store discs into the cases after use.

### To keep discs clean

A dirty disc may not play correctly.

If a disc does become dirty, wipe it with a soft cloth in a straight line from center to edge.



- Do not use any solvent (for example, conventional record cleaner, spray, thinner, benzene, etc.) to clean discs.

### To play new discs

New discs may have some rough spots around the inner and outer edges. If such a disc is used, this unit may reject the disc.



To remove these rough spots, rub the edges with a pencil or ball-point pen, etc.

### Do not use the following discs:

Warped disc



Sticker residue



Stick-on label



## Handling cassettes

### To clean the head

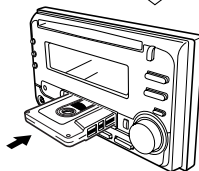
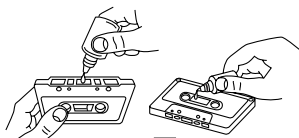

- Clean the heads after every 10 hours of use using a wet-type head cleaning tape (available at an audio store).

When the head becomes dirty, you may realize the following symptoms:

- Sound quality is reduced.
  - Sound level decreases.
  - Sound drops out.
- Do not touch the highly-polished head with any metallic or magnetic tools.

### To keep the tape clean

- Always store the cassettes in their storage cases after use.
- Do not store cassettes in the following places:
  - Subject to direct sunlight
  - With high humidity
  - At extremely hot temperatures

# More about this unit

## Basic operations

### Turning on the power

- By pressing the source buttons on the unit, you can also turn on the power. If the source is ready, playback also starts.

### Turning off the power

- If you turn off the ignition key without turning off this unit, the unit will automatically turn on when you turn on the ignition key next time. If the last selected source is ready for playback (ex. a disc or a tape is in the unit), playback starts automatically.
- If you turn off the power while listening to a disc, disc play will start from where playback has been stopped previously, next time you turn on the power.

### Selecting the sources

- When no disc or cassette is loaded in the unit, “CD” or “TAPE” cannot be selected.
- Without connecting to the CD changer, “CD-CH” cannot be selected.

## Tuner operations

### Storing stations in memory

- During SSM search...
  - All previously stored stations are erased and stations are stored newly.
  - Received stations are preset in No. 1 (lowest frequency) to No. 6 (highest frequency).
  - When SSM is over, the station stored in No. 1 will be automatically tuned in.
- When storing a station manually, a previously preset station is erased when a new station is stored in the same preset number.

## Disc operations

### Caution for DualDisc playback

- The Non-DVD side of a “DualDisc” does not comply with the “Compact Disc Digital Audio” standard. Therefore, the use of Non-DVD side of a DualDisc on this product may not be recommended.

### General

- MP3 and WMA (Windows Media® Audio) “tracks” (words “file” and “track” are used interchangeably) are recorded in “folders.”
- This unit has been designed to reproduce CDs/CD Texts, and CD-Rs (Recordable)/CD-RWs (Rewritable) in audio CD (CD-DA), MP3 and WMA format.
- When a disc has been loaded, selecting “CD” for the playback source starts disc play.

### Inserting a disc

- When a disc is inserted upside down, the disc automatically ejects and the unit starts playing the last selected source.
- Do not insert 8 cm discs (single CD) and unusual shape discs (heart, flower, etc.) into the loading slot.

### Playing a disc

- While fast-forwarding or reversing on an MP3 or WMA disc, you can only hear intermittent sounds.

### Playing a CD-R or CD-RW

- Use only “finalized” CD-Rs or CD-RWs.
- This unit can play back only the files of the same type which is first detected if a disc includes both audio CD (CD-DA) files and MP3/WMA files.
- This unit can play back multi-session discs; however, unclosed sessions will be skipped while playing.

- Some CD-Rs or CD-RWs may not play back on this unit because of their disc characteristics, and for the following causes:
  - Discs are dirty or scratched.
  - Moisture condensation occurs on the lens inside the unit.
  - The pickup lens inside the unit is dirty.
  - CD-R/CD-RW on which the files are written with “Packet Write” method.
  - There are improper recording conditions (missing data, etc.) or media conditions (stain, scratch, warp, etc.).
- CD-RWs may require a longer readout time since the reflectance of CD-RWs is lower than that of regular CDs.
- Do not use the following CD-Rs or CD-RWs:
  - Discs with stickers, labels, or protective seal stuck to the surface.
  - Discs on which labels can be directly printed by an ink jet printer.
 Using these discs under high temperatures or high humidity may cause malfunctions or damages to the unit.
- The maximum number of characters for file/folder names vary among the disc format used (includes 4 extension characters—<.mp3> or <.wma>).
  - ISO 9660 Level 1: up to 12 characters
  - ISO 9660 Level 2: up to 31 characters
  - Romeo\*: up to 128 (72) characters
  - Joliet\*: up to 64 (36) characters
  - Windows long file name\*: up to 128 (72) characters
 \* *The parenthetic figure is the maximum number of characters for file/folder names in case the total number of files and folders is 313 or more.*
- This unit can recognize the total of 512 files, of 200 folders, and of 8 hierarchies.
- This unit can play back the files recorded in VBR (variable bit rate).  
The files recorded in VBR have a discrepancy in elapsed time display, and do not show the actual elapsed time. This difference becomes noticeable especially after performing the search function.
- This unit cannot play back the following files:
  - MP3 files encoded with MP3i and MP3 PRO format.
  - MP3 files encoded in an unappropriated format.
  - MP3 files encoded with Layer 1/2.
  - WMA files encoded with lossless, professional, and voice format.
  - WMA files which are not based upon Windows Media® Audio.
  - WMA files copy-protected with DRM.
  - Files which have the data such as WAVE, ATRAC3, etc.
- The search function works but search speed is not constant.

### **Playing an MP3/WMA disc**

- This unit can play back MP3/WMA files with the extension code <.mp3> or <.wma> (regardless of the letter case—upper/lower).
- This unit can show the names of albums, artists (performer), and ID3 Tag (Version 1.0, 1.1, 2.2, 2.3, or 2.4) for MP3 files and for WMA files.
- This unit can display only one-byte characters. No other characters can be correctly displayed (see page 11).
- This unit can play back MP3/WMA files meeting the conditions below:
  - Bit rate: 8 kbps — 320 kbps
  - Sampling frequency:
    - 48 kHz, 44.1 kHz, 32 kHz (for MPEG-1)
    - 24 kHz, 22.05 kHz, 16 kHz (for MPEG-2)
    - 48 kHz, 44.1 kHz, 32 kHz (for WMA)
  - Disc format: ISO 9660 Level 1/Level 2, Romeo, Joliet, Windows long file name

To be continued...

## Changing the source

- If you change the source, playback also stops (without ejecting the disc).  
Next time you select “CD” or “CD-CH” for the playback source, disc play starts from where it has been stopped previously.

## Ejecting a disc

- If the ejected disc is not removed within 15 seconds, the disc is automatically inserted again into the loading slot to protect it from dust. (Disc will not play this time.)

## Tape operations

### Playing a tape

- While locating a specified tune:
  - If the tape is rewound to its beginning, playback starts from the beginning of that side.
  - If the tape is fast-forwarded to the end, it is reversed and played from the beginning of the other side.
- In the following cases, Multi Music Scan (MMS), Blank Skip, and Repeat Play may not operate correctly:
  - Tapes with tunes having long pianissimo passages (very quiet parts) or non-recorded portions.
  - Tapes with short non-recorded sections.
  - Tapes with high level noise or humming between tunes.
  - The Dolby NR setting does not match. For example, if the tape is recorded with the Dolby C NR.
- Do not use the following tape:
  - Dirty or dusty tapes.
  - Cassette with peeling labels.
  - Loose tape which may become entangled with the mechanism.

## Changing the source

- If you change the source, playback also stops (without ejecting the cassette).

## Ignition key-off release

- When you turn off the ignition key with a cassette in the compartment, the unit automatically releases the tape from its head.

## General settings—PSM

- If you change the “TAG DISP” setting from “TAG OFF” to “TAG ON” while playing MP3/WMA file, the tag display will be activated when the next file starts playing.
- If you change the “AMP GAIN” setting from “HIGH PWR” to “LOW PWR” while the volume level is set higher than “VOLUME 30,” the unit automatically changes the volume level to “VOLUME 30.”

## Other main functions

- If you try to assign a title to the 31st station frequency, “NAME FULL” flashes. Delete unwanted titles before assignment.

### Available characters on the display

These characters (including the Roman alphabets) can use to show other information such as disc title/performer on the display.

#### Russian letters

Upper case

А	Б	В	Г	Д	Е	Ж	З	И	Й	К	Л
М	Н	О	П	Р	С	Т	У	Ф	Х	Ц	Ч
Ш	Щ	Ъ	Ы	Ь	Э	Ю	Я	Ё			

Lower case

а	б	в	г	д	е	ж	з	и	й	к	л
м	н	о	п	р	с	т	у	ф	х	ц	ч
ш	щ	ъ	ы	ь	э	ю	я	ё			

Numbers and symbols

0	1	2	3	4	5	6	7	8	9	!	”
#	\$	%	&	'	(	)	*	+	,	-	.
/	:	;	<	=	>	?	@	-	`	€	

# Troubleshooting

What appears to be trouble is not always serious. Check the following points before calling a service center.

	Symptoms	Remedies/Causes
General	<ul style="list-style-type: none"> <li>• Sound cannot be heard from the speakers.</li> </ul>	<ul style="list-style-type: none"> <li>• Adjust the volume to the optimum level.</li> <li>• Check the cords and connections.</li> </ul>
	<ul style="list-style-type: none"> <li>• The unit does not work at all.</li> </ul>	Reset the unit (see page 2).
FM/AM	<ul style="list-style-type: none"> <li>• SSM automatic presetting does not work.</li> </ul>	Store stations manually.
	<ul style="list-style-type: none"> <li>• Static noise while listening to the radio.</li> </ul>	Connect the aerial firmly.
Disc playback	<ul style="list-style-type: none"> <li>• Disc cannot be played back.</li> </ul>	Insert the disc correctly.
	<ul style="list-style-type: none"> <li>• CD-R/CD-RW cannot be played back.</li> <li>• Tracks on the CD-R/CD-RW cannot be skipped.</li> </ul>	<ul style="list-style-type: none"> <li>• Insert a finalized CD-R/CD-RW.</li> <li>• Finalize the CD-R/CD-RW with the component which you used for recording.</li> </ul>
	<ul style="list-style-type: none"> <li>• Disc can be neither played back nor ejected.</li> </ul>	<ul style="list-style-type: none"> <li>• Unlock the disc (see page 15).</li> <li>• Eject the disc forcibly (see page 2).</li> </ul>
	<ul style="list-style-type: none"> <li>• Disc sound is sometimes interrupted.</li> </ul>	<ul style="list-style-type: none"> <li>• Stop playback while driving on rough roads.</li> <li>• Use an unscratched disc.</li> <li>• Check the cords and connections.</li> </ul>
	<ul style="list-style-type: none"> <li>• “NO DISC” appears on the display.</li> </ul>	Insert a correct disc into the loading slot.
MP3/WMA playback	<ul style="list-style-type: none"> <li>• Disc cannot be played back.</li> </ul>	<ul style="list-style-type: none"> <li>• Use a disc with MP3/WMA tracks recorded in the format compliant with ISO 9660 Level 1, Level 2, Romeo, or Joliet.</li> <li>• Add the extension code &lt;.mp3&gt; or &lt;.wma&gt; to the file names.</li> </ul>
	<ul style="list-style-type: none"> <li>• Noise is generated.</li> </ul>	Skip to another track or change the disc. (Do not add the extension code <.mp3> or <.wma> to non-MP3 or WMA tracks.)
	<ul style="list-style-type: none"> <li>• A longer readout time is required (“CHECK” keeps flashing on the display).</li> </ul>	Do not use too many hierarchies and folders.

To be continued....

	Symptoms	Remedies/Causes
MP3/WMA playback	• Tracks do not play back in the order you have intended them to play.	Playback order is determined when the files are recorded.
	• Elapsed playing time is not correct.	This sometimes occurs during play. This is caused by how the tracks are recorded on the disc.
	• “NO FILES” appears on the display.	Insert a disc that contains MP3/WMA tracks.
	• Correct characters are not displayed (e.g. album name).	This unit can only display alphabets (upper/lower case), numbers, and a limited number of symbols.
Tape playback	• A cassette cannot be inserted.	Insert the cassette with the exposed tape facing right.
	• Cassette can be neither played back nor ejected.	Unlock the cassette (see page 17).
	• “NO TAPE” appears on the display.	Insert a cassette correctly.
	• Cassette tapes become hot.	This is not a malfunction.
	• Tape sound is at very low level and sound quality is degraded.	Clean the tape head using a head cleaning tape.
CD changer	• “NO DISC” appears on the display.	Insert a disc into the magazine.
	• “NO MAG” appears on the display.	Insert the magazine.
	• “RESET 8” appears on the display.	Connect this unit and the CD changer correctly and press the reset button of the CD changer.
	• “RESET 1” – “RESET 7” appears on the display.	Press the reset button of the CD changer.
	• The CD changer does not work at all.	Reset the unit (see page 2).

- Microsoft and Windows Media are either registered trademarks or trademarks of Microsoft Corporation in the United States and/or other countries.



# Specifications

## AUDIO AMPLIFIER SECTION

Maximum Power Output:

Front: 50 W per channel

Rear: 50 W per channel

Continuous Power Output (RMS):

Front: 19 W per channel into 4  $\Omega$ , 40 Hz to 20 000 Hz at no more than 0.8% total harmonic distortion.

Rear: 19 W per channel into 4  $\Omega$ , 40 Hz to 20 000 Hz at no more than 0.8% total harmonic distortion.

Load Impedance: 4  $\Omega$  (4  $\Omega$  to 8  $\Omega$  allowance)

Equalizer Control Range:

Low:  $\pm 12$  dB (60 Hz, 80 Hz, 100 Hz, 120 Hz)

Mid:  $\pm 12$  dB

High:  $\pm 12$  dB (8 kHz, 10 kHz, 12 kHz, 15 kHz)

Frequency Response: 40 Hz to 20 000 Hz

Signal-to-Noise Ratio: 70 dB

Line-Out Level/Impedance:

2.0 V/20 k $\Omega$  load (full scale)

Output Impedance: 1 k $\Omega$

Other terminals: CD changer, AUX (auxiliary) input jack

## TUNER SECTION

Frequency Range:

FM: 87.5 MHz to 108.0 MHz

AM: 531 kHz to 1 602 kHz

### [FM Tuner]

Usable Sensitivity: 11.3 dBf (1.0  $\mu$ V/75  $\Omega$ )

50 dB Quieting Sensitivity:

16.3 dBf (1.8  $\mu$ V/75  $\Omega$ )

Alternate Channel Selectivity (400 kHz): 65 dB

Frequency Response: 40 Hz to 15 000 Hz

Stereo Separation: 30 dB

Capture Ratio: 1.5 dB

### [AM Tuner]

Sensitivity: 20  $\mu$ V

Selectivity: 35 dB

## CD PLAYER SECTION

Type: Compact disc player

Signal Detection System: Non-contact optical pickup (semiconductor laser)

Number of Channels: 2 channels (stereo)

Frequency Response: 5 Hz to 20 000 Hz

Dynamic Range: 96 dB

Signal-to-Noise Ratio: 98 dB

Wow and Flutter: Less than measurable limit

MP3 Decoding Format:

MPEG1/2 Audio Layer 3

Max. Bit Rate: 320 kbps

WMA (Windows Media<sup>®</sup> Audio) Decoding Format:

Max. Bit Rate: 192 kbps

## CASSETTE DECK SECTION

Wow and Flutter: 0.1 % (WRMS)

Fast-Wind Time: 100 sec. (C-60)

Frequency Response: 30 Hz to 16 000 Hz (Normal tape)

Signal-to-Noise Ratio: (Normal tape)

Dolby B NR ON: 65 dB

Dolby B NR OFF: 56 dB

Stereo Separation: 40 dB

## GENERAL

Power Requirement:

Operating Voltage:

DC 14.4 V (11 V to 16 V allowance)

Grounding System: Negative ground

Allowable Operating Temperature:

0°C to +40°C

Dimensions (W  $\times$  H  $\times$  D):

Installation Size (approx.):

178 mm  $\times$  100 mm  $\times$  158 mm

Set Size (approx.):

178 mm  $\times$  100 mm  $\times$  175 mm

Mass (approx.):

2.3 kg (excluding accessories)

*Design and specifications are subject to change without notice.*



**Having TROUBLE with operation?**

**Please reset your unit**

Refer to page of How to reset your unit

**Затруднения при эксплуатации?**

**Пожалуйста, перезагрузите Ваше устройство**

Для получения информации о перезагрузке Вашего устройства  
обратитесь на соответствующую страницу

**JVC**



EN, RU

© 2005 Victor Company of Japan, Limited

1005DTSMDTJEIN

# JVC KW-XC407

## Installation/Connection Manual

### Руководство по установке/подключению

GET0329-002A  
[EE]

1005DTSMDTJEIN  
EN, RU  
© 2005 Victor Company of Japan, Limited

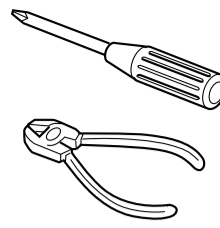

#### ENGLISH

This unit is designed to operate on **12 V DC, NEGATIVE ground electrical systems**. If your vehicle does not have this system, a voltage inverter is required, which can be purchased at JVC IN-CAR ENTERTAINMENT dealers.

#### РУССКИЙ

Это устройство разработано для эксплуатации на **12 В постоянного напряжения с минусом на массе**. Если Ваш автомобиль не имеет этой системы, требуется инвертор напряжения, который может быть приобретен у дилера автомобильного специалиста JVC IN-CAR ENTERTAINMENT.

#### Parts list for installation and connection

The following parts are provided for this unit.  
After checking them, please set them correctly.



Flat countersunk screws (M5 x 8 mm)  
Болт с плоской потайной головкой (M5 x 8 mm)



Binding screws (M5 x 8 mm)  
Зажимной болт (M5 x 8 mm)

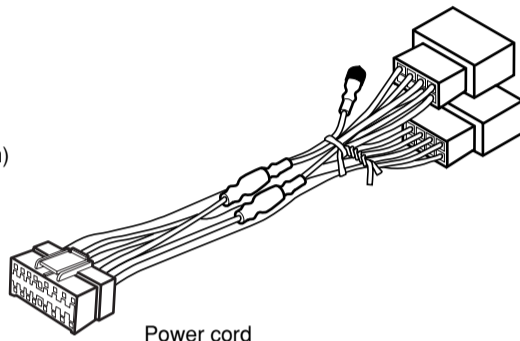

Power cord  
Кабель питания



CR2025

Battery  
Батарейка



RM-RK50

Remote controller  
дистанционного управления

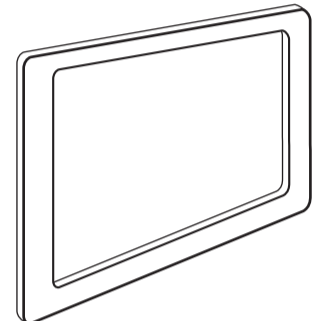

Plate for use with a Nissan car  
Пластина для автомобилей марки Nissan

#### When installing the unit in a Nissan car

#### Установка устройства в автомобиле марки Nissan

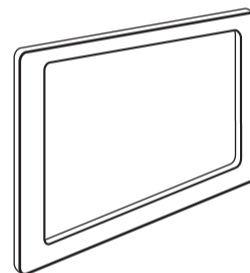
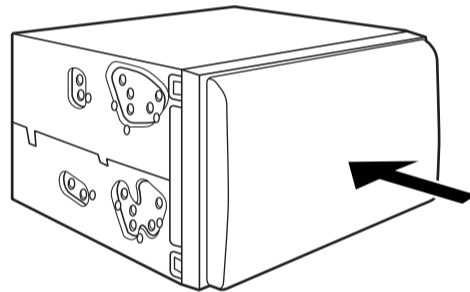
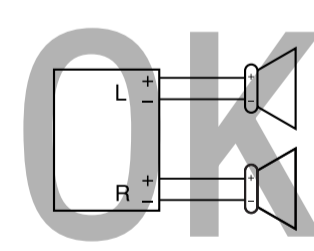
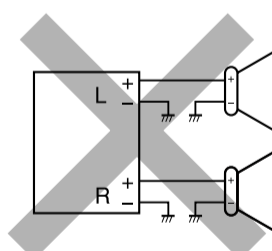
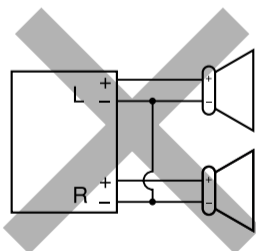

Plate for use with a Nissan car  
Пластина для автомобилей марки Nissan

Fix the supplied plate as illustrated.  
Закрепите прилагаемую пластину, как показано на рисунке.

#### PRECAUTIONS on power supply and speaker connections:

- **DO NOT** connect the speaker leads of the power cord to the car battery; otherwise, the unit will be seriously damaged.
- **BEFORE** connecting the speaker leads of the power cord to the speakers, check the speaker wiring in your car.



#### ПРЕДОСТЕРЕЖЕНИЯ по питанию и подключению громкоговорителей:

- **НЕ** подключайте провода громкоговорителей к аккумулятору автомобиля, иначе устройство будет повреждено.
- **ПЕРЕД** подключением проводов громкоговорителей к кабелю питания громкоговорителя проверьте схему соединений громкоговорителей в Вашем автомобиле.

#### TROUBLESHOOTING

- **The fuse blows.**
  - \* Are the red and black leads connected correctly?
- **Power cannot be turned on.**
  - \* Is the yellow lead connected?
- **No sound from the speakers.**
  - \* Is the speaker output lead short-circuited?
- **Sound is distorted.**
  - \* Is the speaker output lead grounded?
  - \* Are the “-” terminals of L and R speakers grounded in common?
- **Noise interfere with sounds.**
  - \* Is the rear ground terminal connected to the car’s chassis using shorter and thicker cords?
- **Unit becomes hot.**
  - \* Is the speaker output lead grounded?
  - \* Are the “-” terminals of L and R speakers grounded in common?
- **This unit does not work at all.**
  - \* Have you reset your unit?

#### ВЫЯВЛЕНИЕ НЕИСПРАВНОСТЕЙ

- **Сработал предохранитель.**
  - \* Правильно ли подключены черный и красный провода?
- **Питание не включается.**
  - \* Подключен ли желтый провод?
- **Звук не выводится через громкоговорители.**
  - \* Нет ли короткого замыкания на кабеле выхода громкоговорителей?
- **Звук искажен.**
  - \* Заземлен ли провод выхода громкоговорителей?
  - \* Заземлены ли разъемы “-” правого (R) и левого (L) громкоговорителей?
- **Шум мешает звучанию.**
  - \* Соединен ли находящийся сзади зажим заземления с шасси автомобиля с помощью более короткого и тонкого шнуров?
- **Устройство нагревается.**
  - \* Заземлен ли провод выхода громкоговорителей?
  - \* Заземлены ли разъемы “-” правого (R) и левого (L) громкоговорителей?
- **Приемник не работает.**
  - \* Выполнена ли перенастройка приемника?

## INSTALLATION (IN-DASH MOUNTING)

The following illustration shows a typical installation. However, you should make adjustments corresponding to your specific car. In this case consult the manual included with the installation kit (option).

In some case, depending of the type and the model of your car, it is not possible to install the unit into the center console.

If you have any questions or require information regarding installation kits, consult your JVC IN-CAR ENTERTAINMENT or a company supplying kits.

- If you are not sure how to install this unit correctly, have it installed by a qualified technician.

### Before installing the unit

- When mounting the unit, be sure to use the screws provided, as instructed. If other screws are used, there is a possibility that parts could become loose or damaged.
- When tightening screws or bolts be careful not to pinch any connection cord.

- 1 Remove the audio system originally installed together with the mounting brackets.  
**Note:** Be sure to keep all the screws and parts removed from your car for future use.
- 2 Attach the mounting brackets (removed from the car), to this unit (see below).
- 3 Connect the wires (see diagram ).
- 4 Fix this unit to the car using the screws removed in step 1.
  - See "Caution" below.

The following example shown is for installation in a Toyota car.  
For more details, consult your JVC IN-CAR ENTERTAINMENT dealer.

## УСТАНОВКА (УСТАНОВКА В ПРИБОРНУЮ ПАНЕЛЬ)

На следующей иллюстрации показана типовая установка. Однако возможны дополнительные регулировки в соответствии с определенным автомобилем. В этом случае обратитесь к руководству, включенному в монтажный комплект (поставляется отдельно).

В некоторых случаях, в зависимости от типа и модели автомобиля, устройство можно установить на центральной панели.

При появлении вопросов или при необходимости получения информации относительно монтажных комплектов обратитесь к поставщику автомобильных аудиосистем компании JVC IN-CAR ENTERTAINMENT или в компанию, поставляющую монтажные комплекты.

- Если Вы не знаете точно, как следует устанавливать это устройство, обратитесь к квалифицированному специалисту.

### Перед установкой устройства

- При установке устройства используйте только прилагаемые болты в соответствии с инструкцией. В случае использования других болтов существует вероятность, что детали могут быть потеряны или повреждены.
- Аккуратно затягивайте болты, чтобы не пережать соединительные кабели.

- 1 Извлеките первоначально установленную аудиосистему вместе с крепежными скобами.  
**Примечание:** Убедитесь в том, что все болты и детали системы извлечены из автомобиля для будущего использования.
- 2 Прикрепите крепежные скобы, извлеченные из автомобиля, к данному устройству (см. ниже).
- 3 Подключите провода (см. схему .
- 4 Закрепите данное устройство в автомобиле с помощью болтов, извлеченных в действии 1.
  - См. предостережение ниже.

На следующем рисунке показана установка устройства в автомобиле марки Toyota.  
За более подробной информацией обратитесь к поставщику автомобильных аудиосистем компании JVC IN-CAR ENTERTAINMENT.

Securely connect the ground wire to the metal body of the car using the screw originally fixed to the metal body of the car.  
Плотно прикрепите заземляющий провод к металлическим частям автомобиля с помощью уже имеющихся там болтов.

Mounting bracket removed from the car  
Извлеченные из автомобиля крепежные скобы

Screws supplied for this unit  
Болты, поставляемые с данным устройством

Mounting bracket removed from the car  
Извлеченные из автомобиля крепежные скобы

Screws supplied for this unit  
Болты, поставляемые с данным устройством

Screw removed from the car in step 1  
Болты, извлеченные из автомобиля в действии 1

### Screws supplied for this unit:

#### Болты, поставляемые с данным устройством:

Select the proper screw type, fitting to your car.  
Подберите подходящий для автомобиля тип болта.

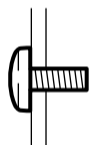

Binding screws (M5 x 8 mm)  
Зажимной болт (M5 x 8 мм)

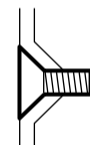

Flat countersunk screws (M5 x 8 mm)  
Болт с плоской потайной головкой (M5 x 8 мм)

### Caution:

To install the mounting brackets to the unit, use only the supplied screws (M5 x 8 mm). If you use any screw longer than 8 mm, the unit can be damaged.

### предостережение

Для прикрепления крепежных скоб к устройству используйте только прилагаемые болты (M5 x 8 мм). Использование любых болтов длиной более 8 мм может привести к повреждению устройства.

If there is an interfering tab on the mounting bracket, bent it flat.  
Если на крепежных скобах есть мешающие установке угловатые фиксаторы, разогните их.

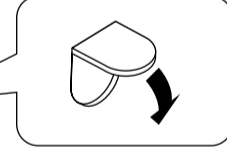
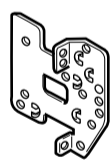

Install the unit at an angle of less than 30°.  
Установите устройство под углом менее 30°.

Less than 30°  
Менее 30°

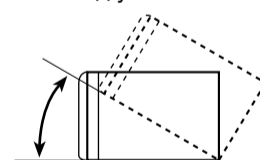

## ELECTRICAL CONNECTIONS

To prevent short circuits, we recommend that you disconnect the battery's negative terminal and make all electrical connections before installing the unit.

- Be sure to ground this unit to the car's chassis again after installation.

### Notes:

- Replace the fuse with one of the specified rating. If the fuse blows frequently, consult your JVC IN-CAR ENTERTAINMENT dealer.
- If noise is a problem...  
This unit incorporates a noise filter in the power circuit. However, with some vehicles, clicking or other unwanted noise may occur. If this happens, connect the unit's **rear ground terminal** (see connection diagram) to the car's chassis using shorter and thicker cords, such as copper braiding or gauge wire. If noise still persists, consult your JVC IN-CAR ENTERTAINMENT dealer.
- It is recommended to connect to the speakers with maximum power of more than 50 W (both at the rear and at the front, with an impedance of 4 Ω to 8 Ω). If the maximum power is less than 50 W, change "AMP GAIN" setting to prevent the speakers from being damaged (see page 21 of the INSTRUCTIONS).
- The heat sink becomes very hot after use. Be careful not to touch it when removing this unit.

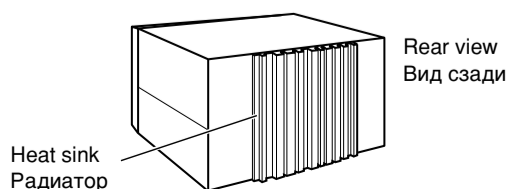

## ЭЛЕКТРИЧЕСКИЕ ПОДКЛЮЧЕНИЯ

Для предотвращения коротких замыканий мы рекомендуем Вам отсоединить отрицательный разъем аккумулятора и осуществить все подключения перед установкой устройства.

- После установки обязательно заземлите данное устройство на шасси автомобиля.

### Примечания:

- Заменяйте предохранитель другим предохранителем указанного класса. Если предохранитель сгорает слишком часто, обратитесь к дилеру JVC IN-CAR ENTERTAINMENT.
- При появлении сильных помех...  
Это устройство оснащено фильтром помех в цепи питания. Однако в некоторых случаях возможно появление щелчков и других нежелательных помех. В этом случае подключите **задний разъем заземления** этого устройства (см. схему подключения ниже) к шасси автомобиля при помощи более коротких и толстых проводов. Если помехи не исчезают, обратитесь к дилеру JVC IN-CAR ENTERTAINMENT.
- Рекомендуется подключать динамики с максимальной мощностью более 50 Вт (к задней и передней панели устройства, с полным сопротивлением от 4 Ω до 8 Ω). Если максимальная мощность динамиков менее 50 Вт, перейдите в режим "AMP GAIN", чтобы предотвратить их повреждение (см. стр. 21 ИНСТРУКЦИИ ПО ЭКСПЛУАТАЦИИ).
- Радиатор во время использования сильно нагревается. Старайтесь его не трогать во время удаления устройства.

**A If your car is equipped with the ISO connector / Если автомобиль оснащен разъемом ISO**

- Connect the ISO connectors as illustrated.
- Подключите разъемы ISO, как показано на рисунке.

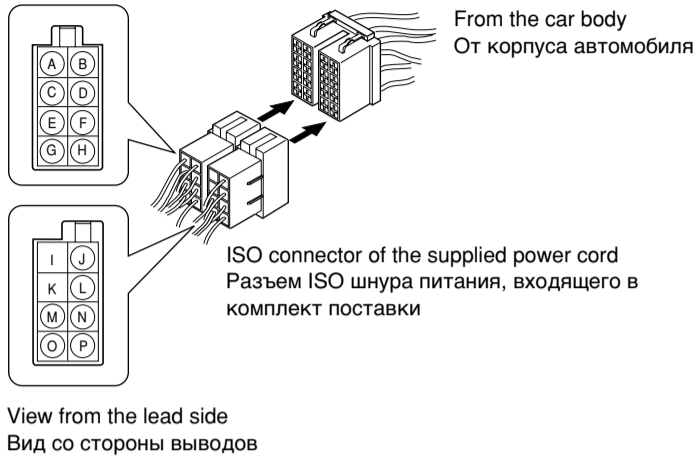

**For some VW/Audi or Opel (Vauxhall) automobile / Для некоторых автомобилей VW/Audi или Opel (Vauxhall)**

- You may need to modify the wiring of the supplied power cord as illustrated.
- Contact your authorized car dealer before installing this unit.
  - Возможно, потребуется изменить схему соединений для прилагаемого шнура питания, как показано на рисунке.
  - Перед установкой приемника обратитесь к авторизованному агенту по продажам автомобильных систем.

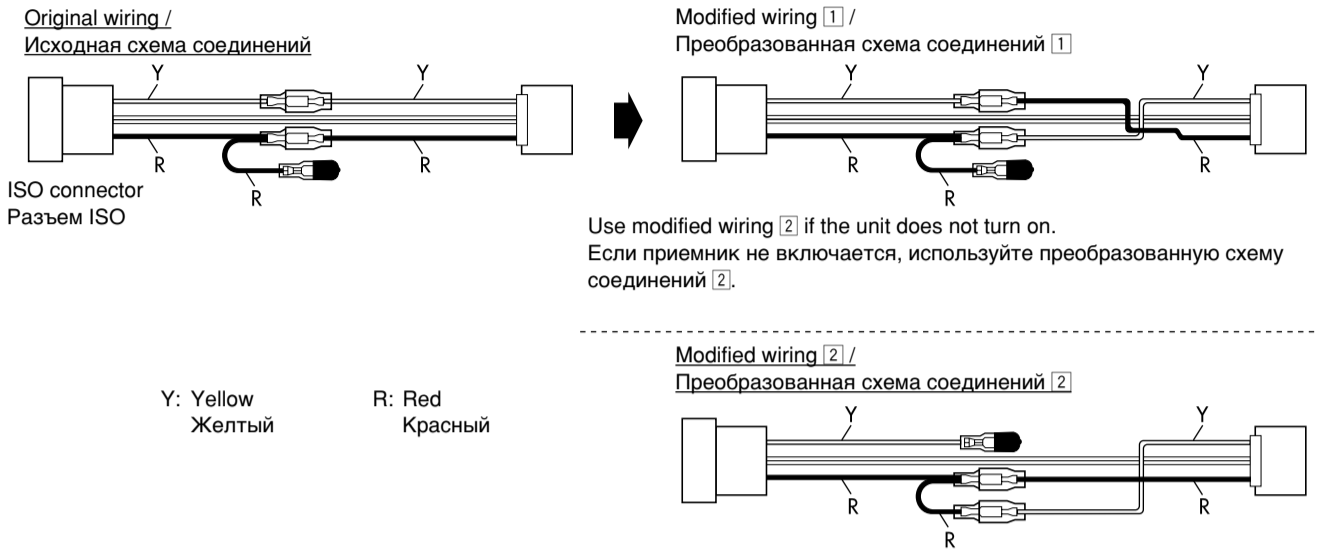

**B Connections without using the ISO connectors / Подключение без использования разъемов ISO**

**Before connecting:** Check the wiring in the vehicle carefully. Incorrect connection may cause serious damage to this unit. The leads of the power cord and those of the connector from the car body may be different in color.

- 1 Cut the ISO connector.
- 2 Connect the colored leads of the power cord in the order specified in the illustration below.
- 3 Connect the aerial cord.
- 4 Finally connect the wiring harness to the unit.

**Перед началом подключений:** Тщательно проверьте проводку в автомобиле. Неправильное подключение может привести к серьезному повреждению устройства. Жилы силового кабеля и жилы соединителя от кузова автомобиля могут быть разного цвета.

- 1 Обрежьте разъем ISO.
- 2 Подсоедините цветные провода шнура питания в указанном ниже порядке.
- 3 Подключите кабель антенны.
- 4 В последнюю очередь подключите электропроводку к устройству.

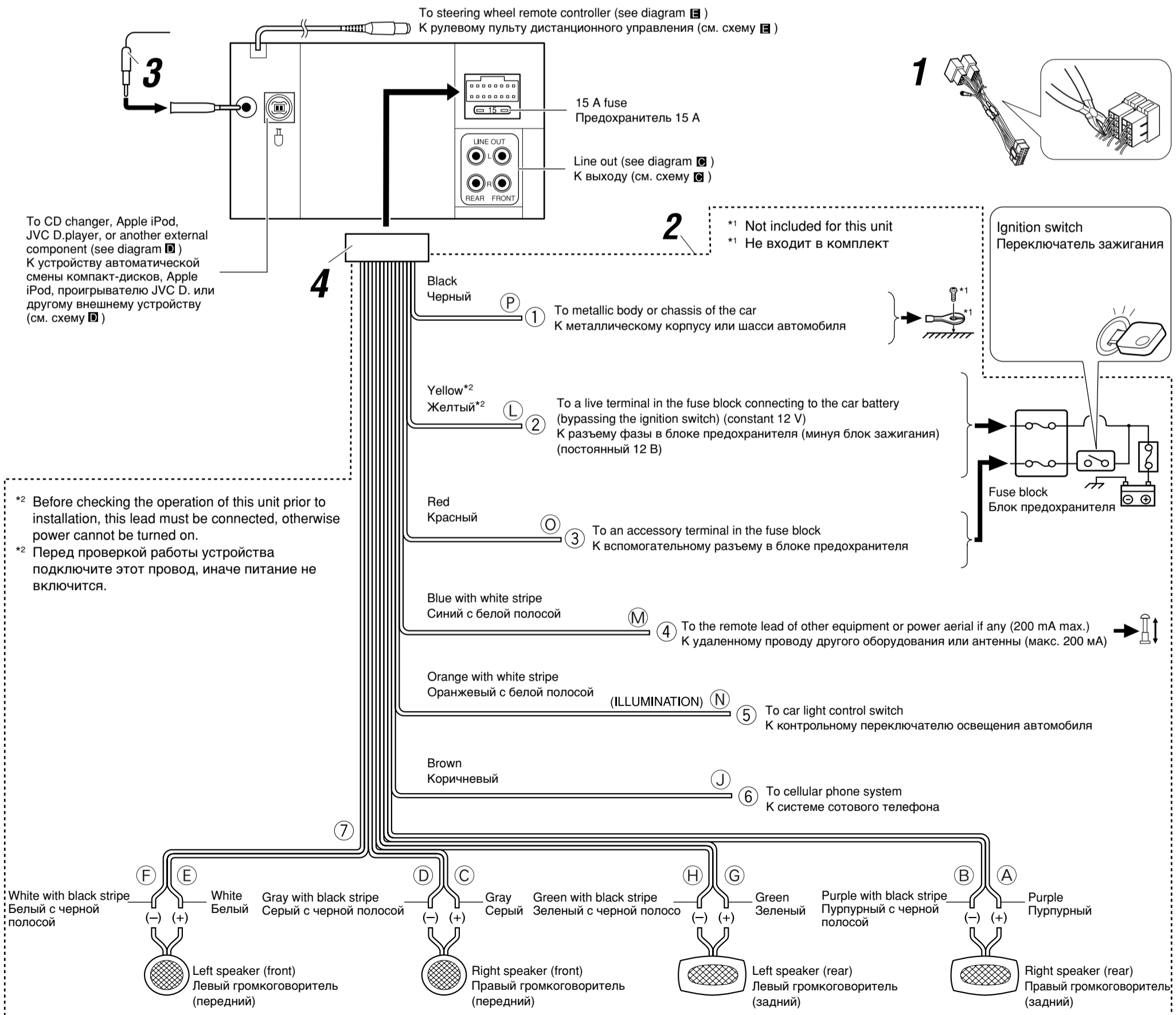



## C Connecting the external amplifiers / Подключение внешних усилителей

You can connect amplifiers to upgrade your car stereo system.

- Connect the remote lead (blue with white stripe) to the remote lead of the other equipment so that it can be controlled through this unit.
- **Disconnect the speakers from this unit, connect them to the amplifier. Leave the speaker leads of this unit unused.**

Можно подключить усилители для обновления автомобильной стереосистемы.

- Подсоедините провод внешнего устройства (синий с белой полосой) к проводу внешнего устройства другого оборудования так, чтобы им можно было управлять с этого устройства.
- **Отсоедините громкоговорители от данного устройства, подключите их к усилителю. Оставьте провода громкоговорителей данного устройства неиспользованными.**

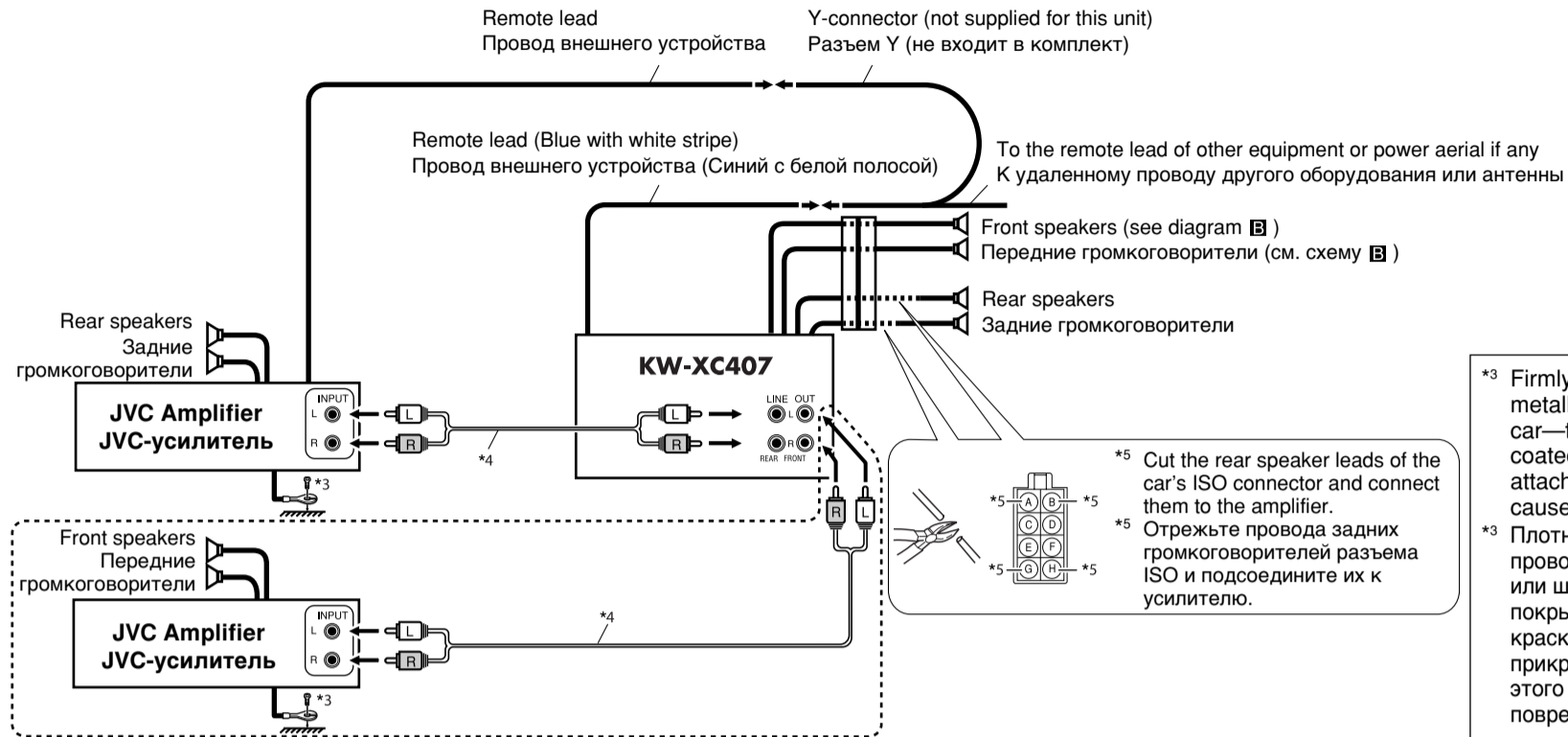

## D Connecting the external components / Подключение внешних устройств

- Set "EXT INPUT" to "CHANGER" (see page 21 of the INSTRUCTIONS). / Для параметра "EXT INPUT" установите значение "CHANGER" (см. стр. 21 ИНСТРУКЦИИ ПО ЭКСПЛУАТАЦИИ).

### CD Changer / Проигрыватель нескольких компакт-дисков

### Apple iPod® or JVC D. player / проигрыватель Apple iPod® или JVC D.

You can connect an iPod or a D. player using an interface adapter (not supplied)—KS-PD100 (for iPod) or KS-PD500 (for D. player).

Можно подключить проигрыватель iPod или D. с помощью интерфейсного адаптера (не входит в комплект поставки)—KS-PD100 (для iPod) или KS-PD500 (для проигрывателя D.).

iPod is a trademark of Apple Computer, Inc., registered in the U.S. and other countries. iPod является торговой маркой Apple Computer, Inc., зарегистрированной в США и других странах.

Apple iPod  
(separately purchased)  
Apple iPod  
(продается отдельно)

CD changer jack  
Разъем устройства автоматической смены компакт-дисков

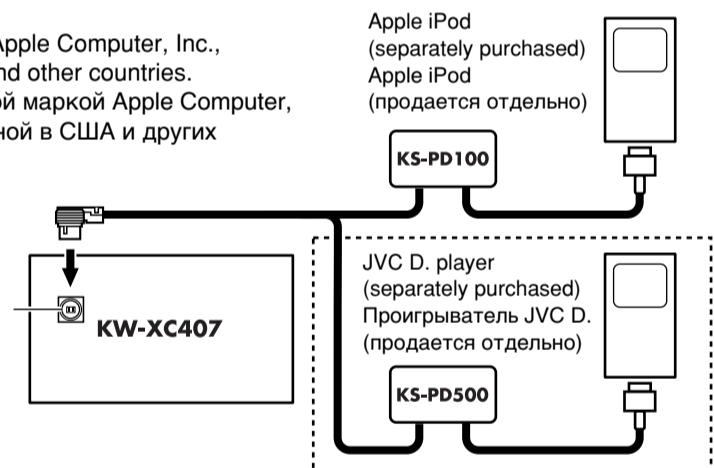

#### CAUTION / ПРЕДОСТЕРЕЖЕНИЕ:

- Before connecting the CD changer, make sure the unit is turned off.
- Перед подключением устройства автоматической смены компакт-дисков, что приемник отключен.

- \*6 Connecting cord supplied for your CD changer
- \*6 Подключение кабеля, входящего в комплект поставки устройства автоматической смены компакт-дисков

- Set "EXT INPUT" to "EXT INPUT" (see page 21 of the INSTRUCTIONS). / Для параметра "EXT INPUT" установите значение "EXT INPUT" (см. стр. 21 ИНСТРУКЦИИ ПО ЭКСПЛУАТАЦИИ).

### External Component / Внешнее устройство

You can connect an external component using a line input adapter, KS-U57 (not supplied) or AUX input adapter, KS-U58 (not supplied).

Можно подключить внешнее устройство с помощью линейного адаптера входа KS-U57 (не входят в комплект поставки) или адаптера входа для подключения внешних устройств (AUX) KS-U58 (не входят в комплект поставки).

CD changer jack  
Разъем устройства автоматической смены компакт-дисков

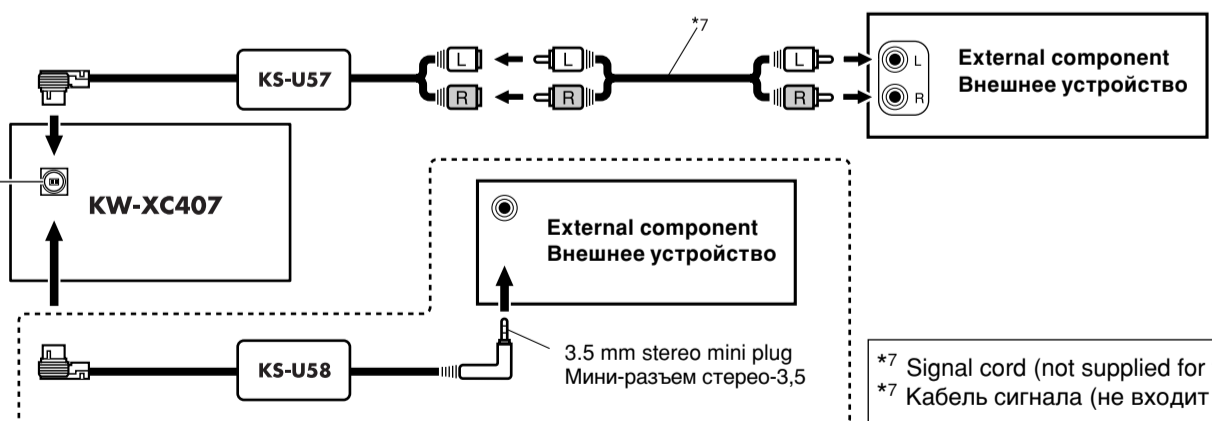

## E Connecting to the steering wheel remote controller / Подключение к рулевому пульту дистанционного управления

If your car is equipped with the steering wheel remote controller, you can operate this unit using the controller. To do it, a JVC's OE remote adapter (not supplied) which matches with your car is required. Consult your JVC IN-CAR ENTERTAINMENT dealer for details. Если автомобиль оборудован рулевым пультом дистанционного управления, его можно использовать для управления данным устройством. Для этого необходим адаптер рулевого пульта дистанционного управления JVC OE (не поставляется), подходящий для Вашего автомобиля. За более подробной информацией обратитесь к поставщику автомобильных аудиосистем компании JVC IN-CAR ENTERTAINMENT.

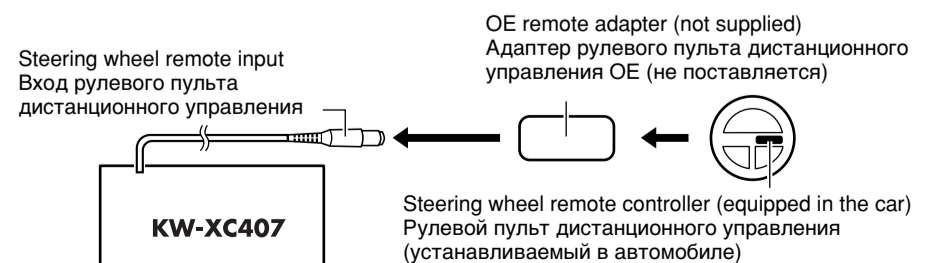

# JVC

## SCHEMATIC DIAGRAMS

### CD/CASSETTE RECEIVER

# KW-XC400, KW-XC407

CD-ROM No.SML200512

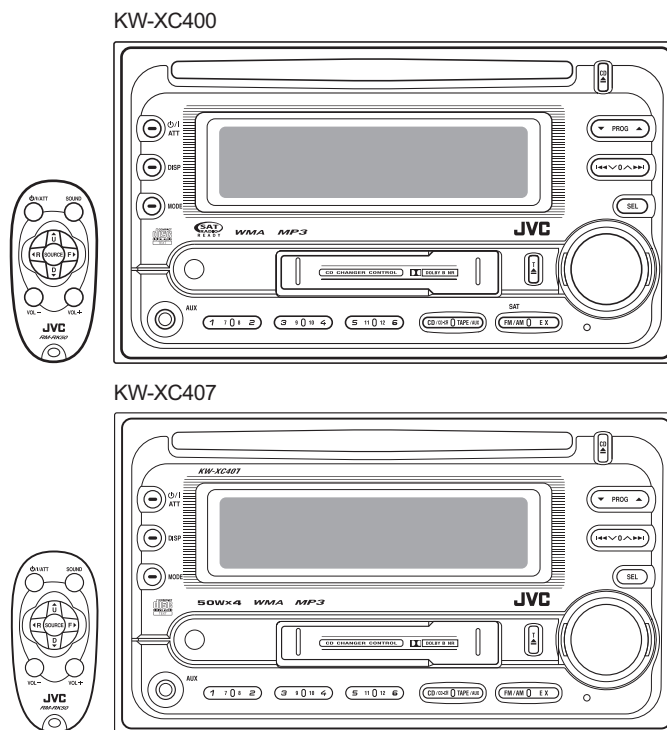

<b>KW-XC400</b>
<b>Area suffix</b> J ----- Northern America
<b>KW-XC407</b>
<b>Area suffix</b> EE ----- Russian Federation



Lead free solder used in the board (material : Sn-Ag-Cu, melting point : 219 Centigrade)

### Contents

Block diagram .....	2-1
Standard schematic diagrams .....	2-3
Printed circuit boards .....	2-19 to 25

## Safety precaution

 **CAUTION** Burrs formed during molding may be left over on some parts of the chassis. Therefore, pay attention to such burrs in the case of performing repair of this system.

 **CAUTION** Please use enough caution not to see the beam directly or touch it in case of an adjustment or operation check.



< MEMO >

# Block diagram

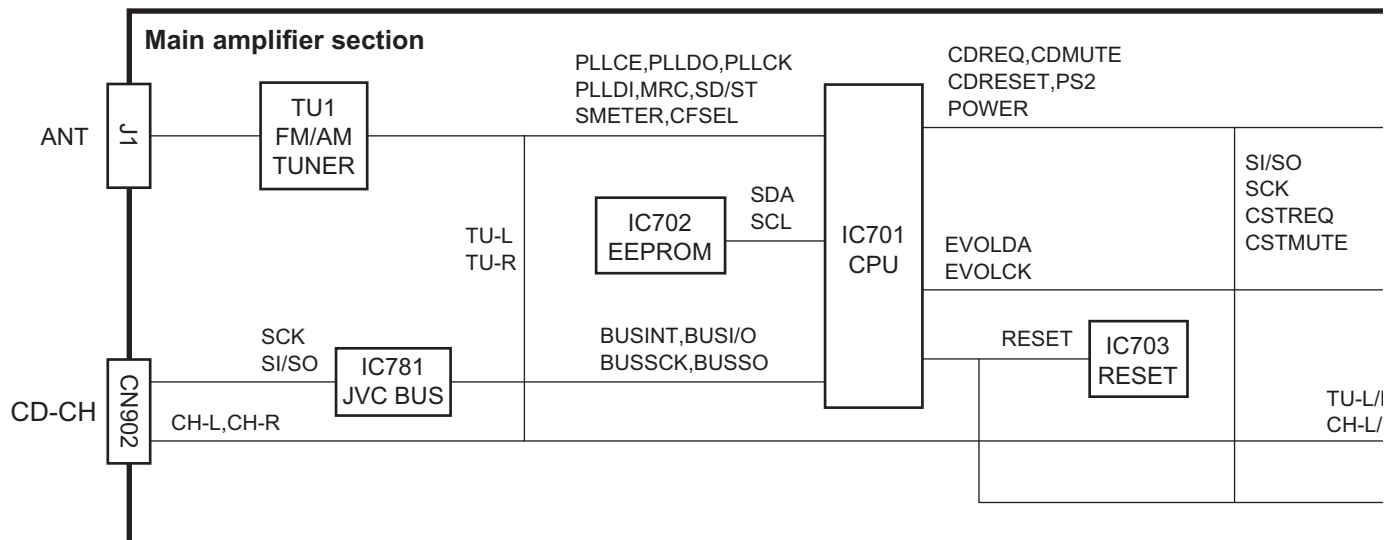
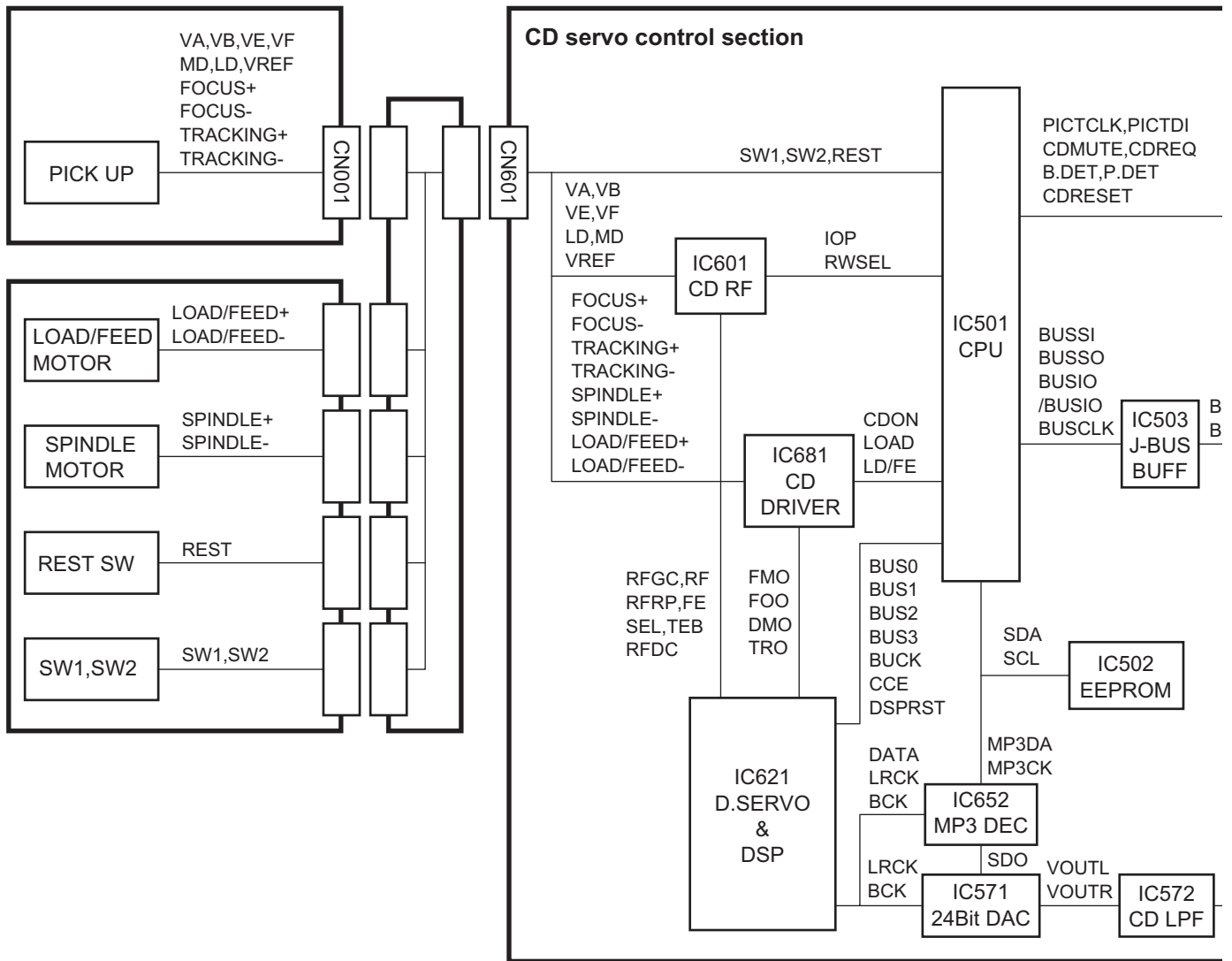

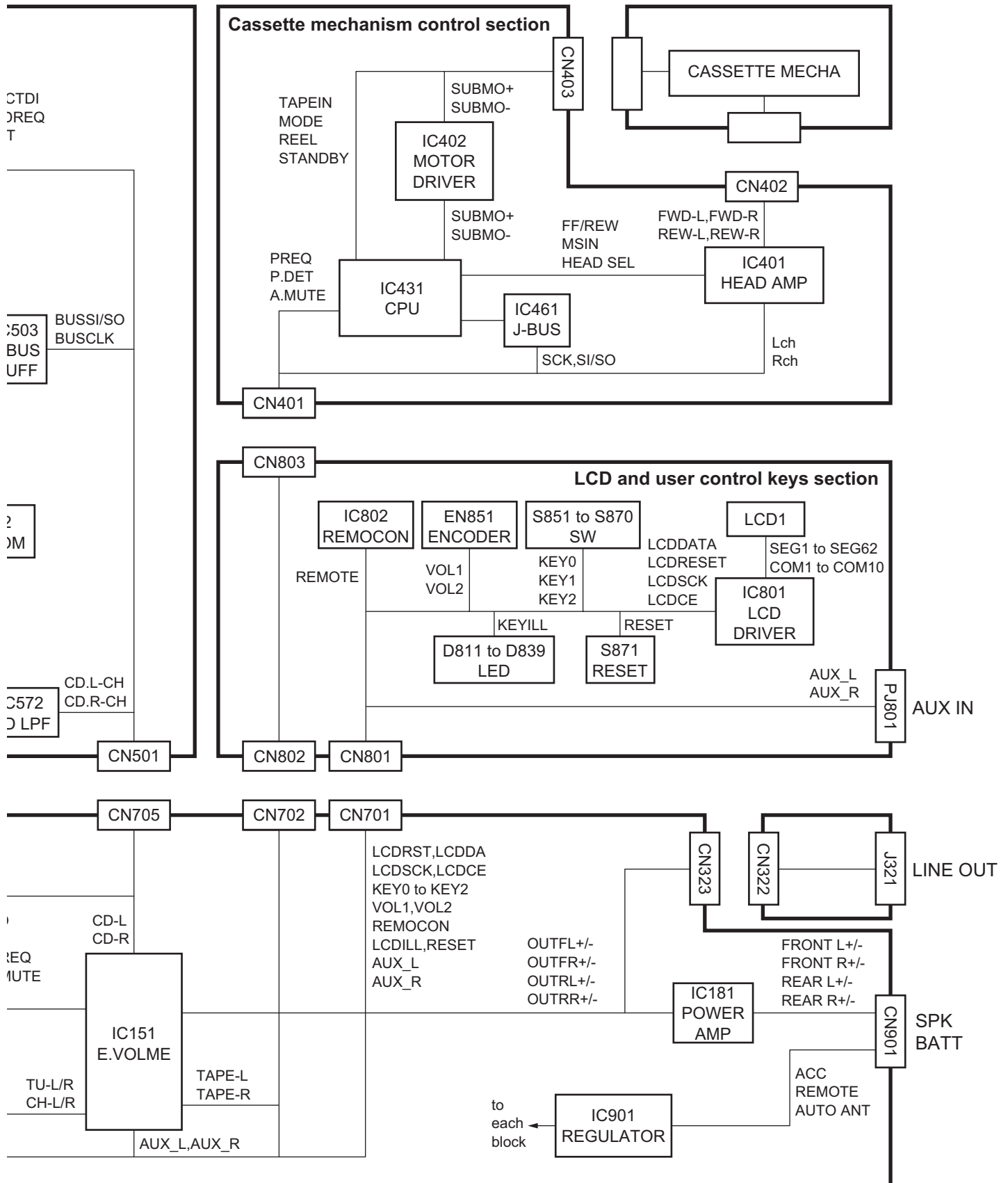

# Standard schematic diagrams

## ■ Main amplifier section (For KW-XC400)

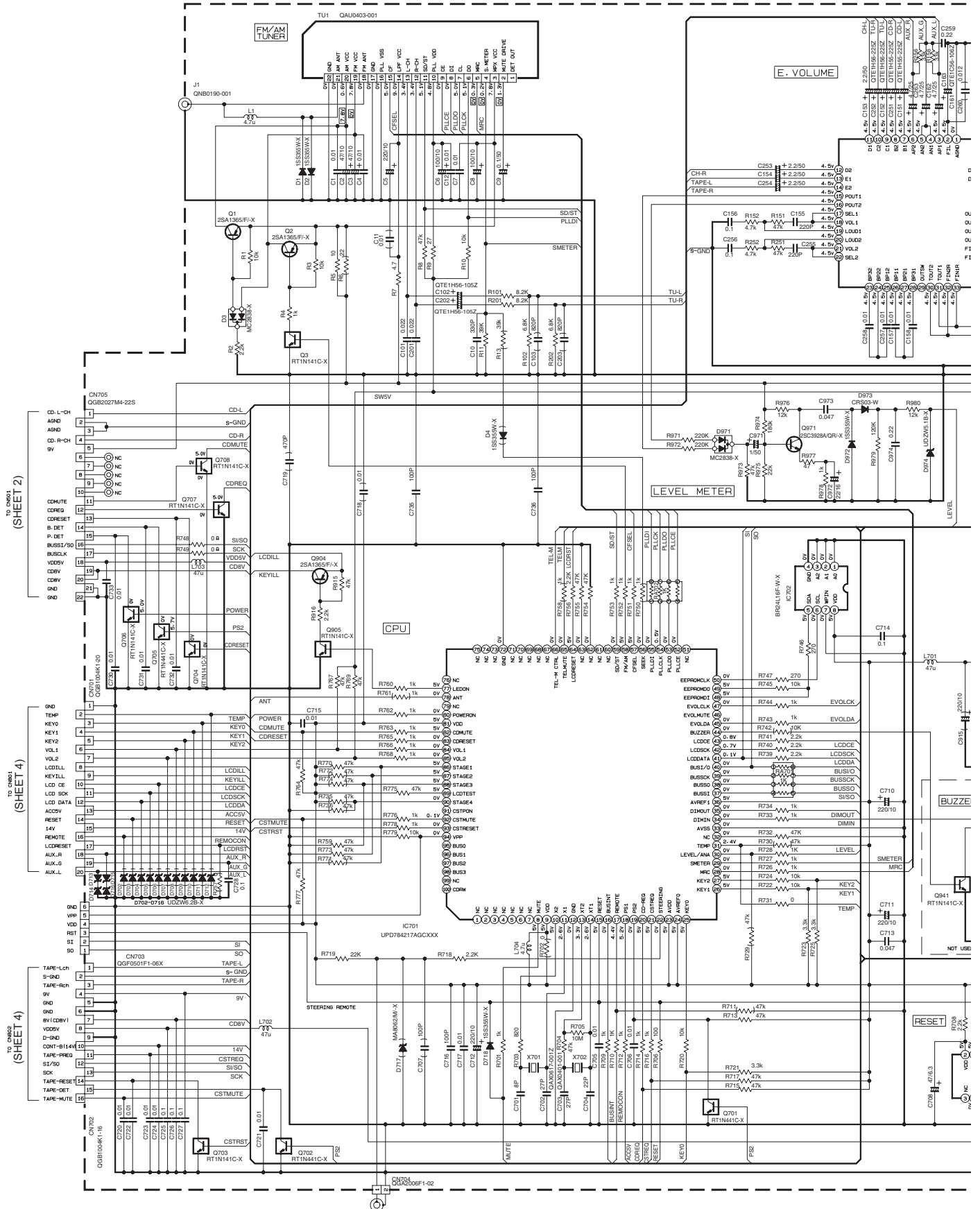

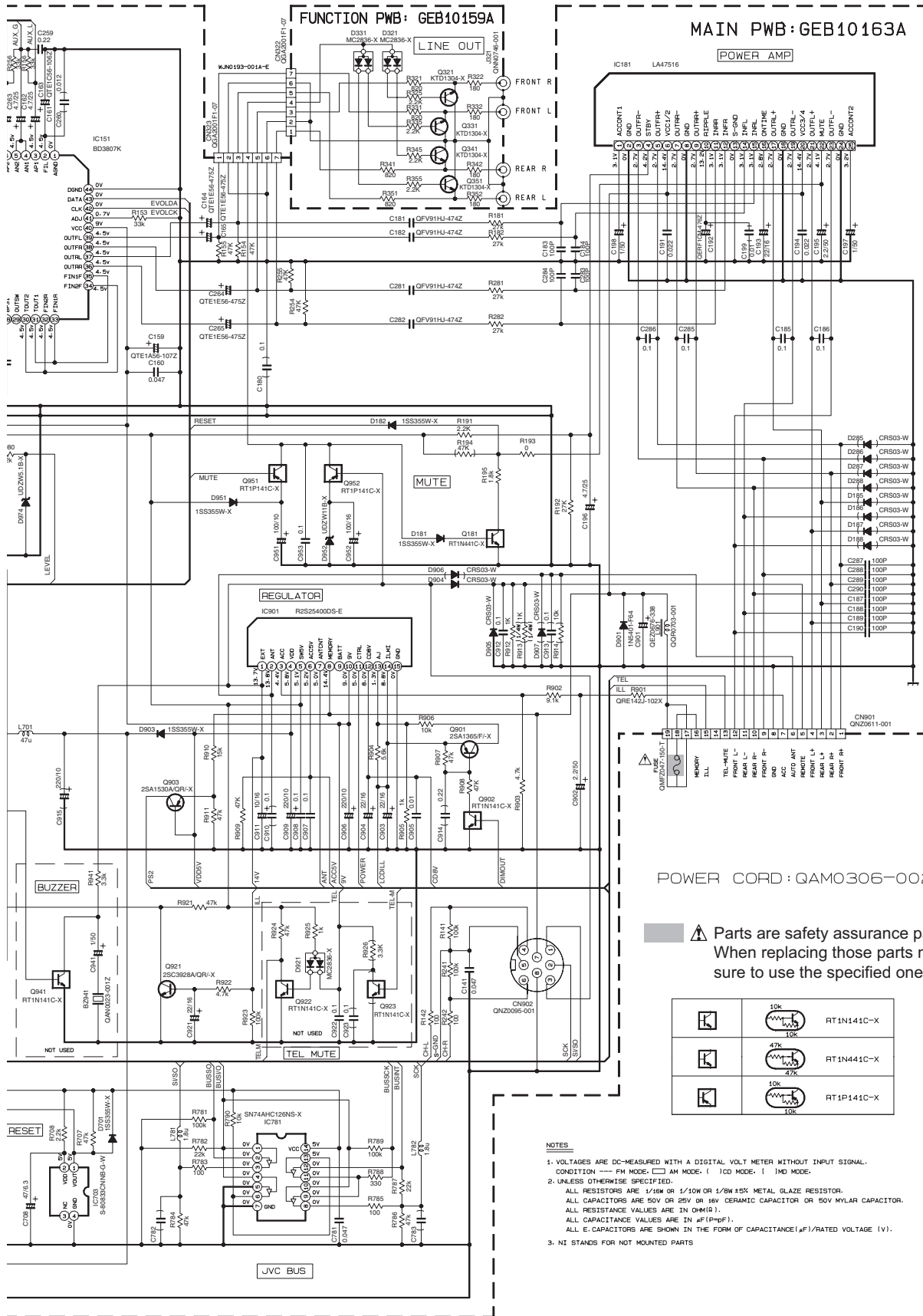

POWER CORD : QAM0306-002

⚠ Parts are safety assurance parts. When replacing those parts make sure to use the specified one.

		RT1N141C-X
		RT1N441C-X
		RT1P141C-X

- NOTES**
- VOLTAGES ARE DC-MEASURED WITH A DIGITAL VOLT METER WITHOUT INPUT SIGNAL. CONDITION --- FM MODE, □ AM MODE, ( ) CD MODE, | IMD MODE.
  - UNLESS OTHERWISE SPECIFIED: ALL RESISTORS ARE 1/8W OR 1/10W OR 1/8W±5% METAL GLAZE RESISTOR. ALL CAPACITORS ARE 50V OR 25V OR 16V CERAMIC CAPACITOR OR 50V MYLAR CAPACITOR. ALL RESISTANCE VALUES ARE IN OHM(Ω). ALL CAPACITANCE VALUES ARE IN μF(P=PF). ALL E-CAPACITORS ARE SHOWN IN THE FORM OF CAPACITANCE(μF)/RATED VOLTAGE (V).
  - NI STANDS FOR NOT MOUNTED PARTS

# CD servo control section (For KW-XC400)

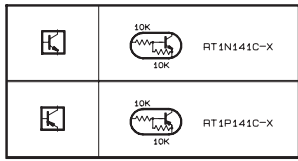
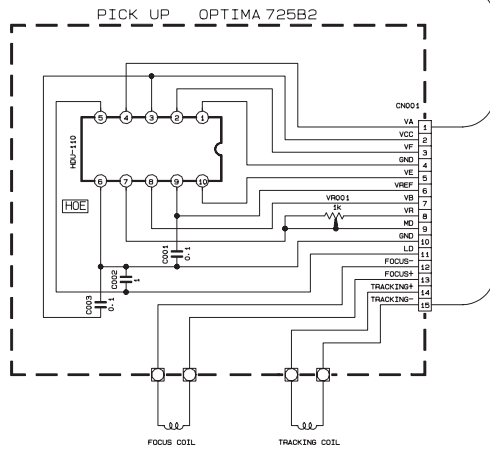
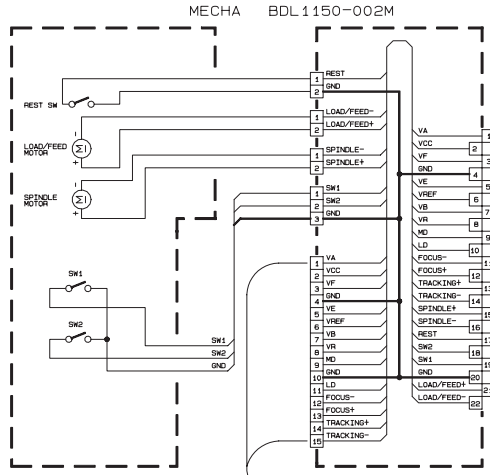

- NOTES**
- VOLTAGES ARE DC-MEASURED WITH A DIGITAL VOLT METER WITHOUT INPUT SIGNAL. CONDITION --- CD MODE.
  - UNLESS OTHERWISE SPECIFIED.
  - ALL RESISTORS ARE 1/10W OR 1/8W OR 1/4W 5% METAL GLAZE RESISTOR.
  - ALL CAPACITORS ARE 50V OR 25V OR 16V CERAMIC CAPACITOR OR 50V MYLAR CAPACITOR.
  - ALL RESISTANCE VALUES ARE IN OHMS (Ω).
  - ALL CAPACITANCE VALUES ARE IN μF(PpF).
  - ALL E-CAPACITORS ARE SHOWN IN THE FORM OF CAPACITANCE(μF)/RATED VOLTAGE (V).
  - COMPONENTS IN ( ) INDICATE NOT USE.

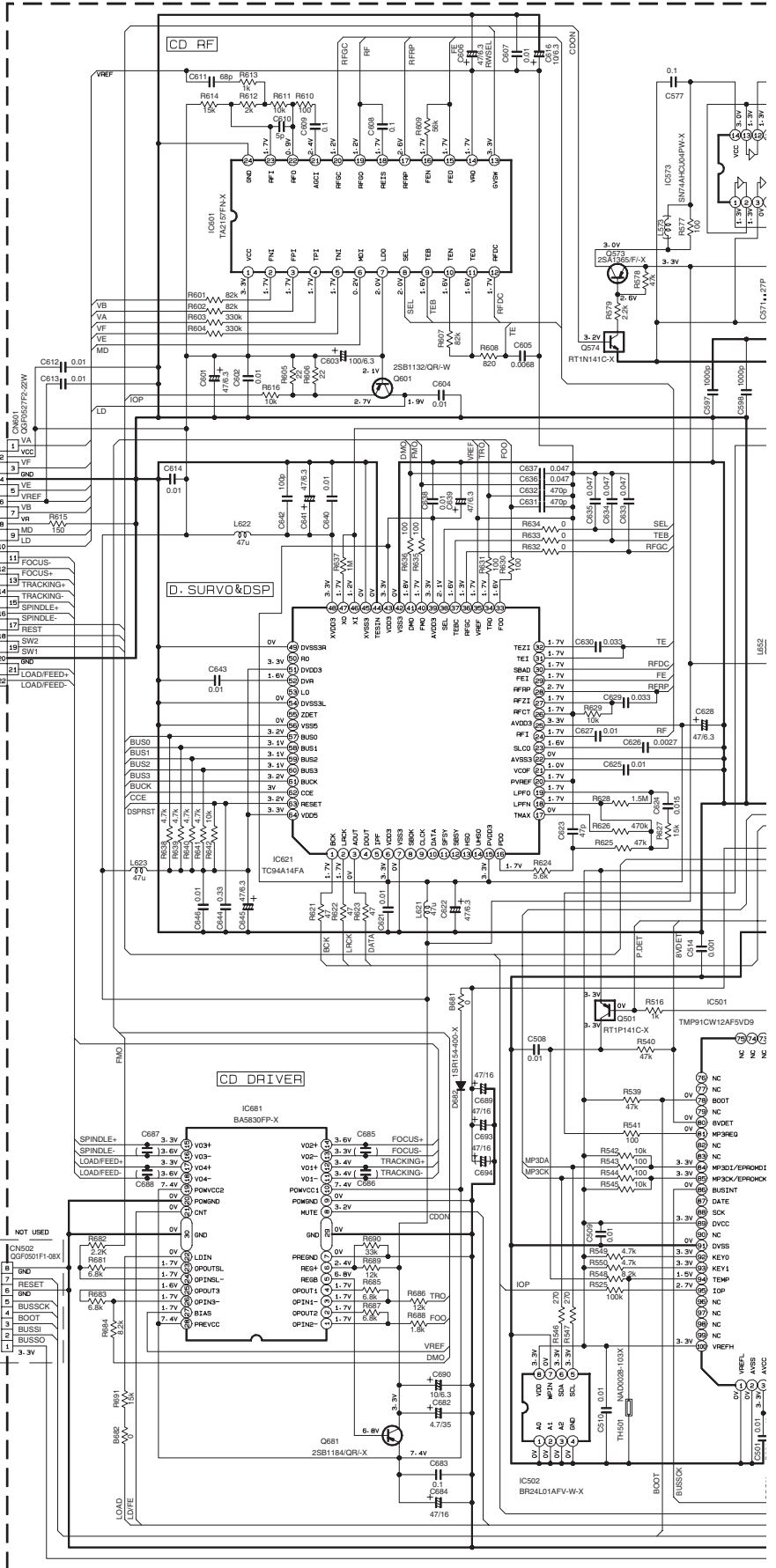

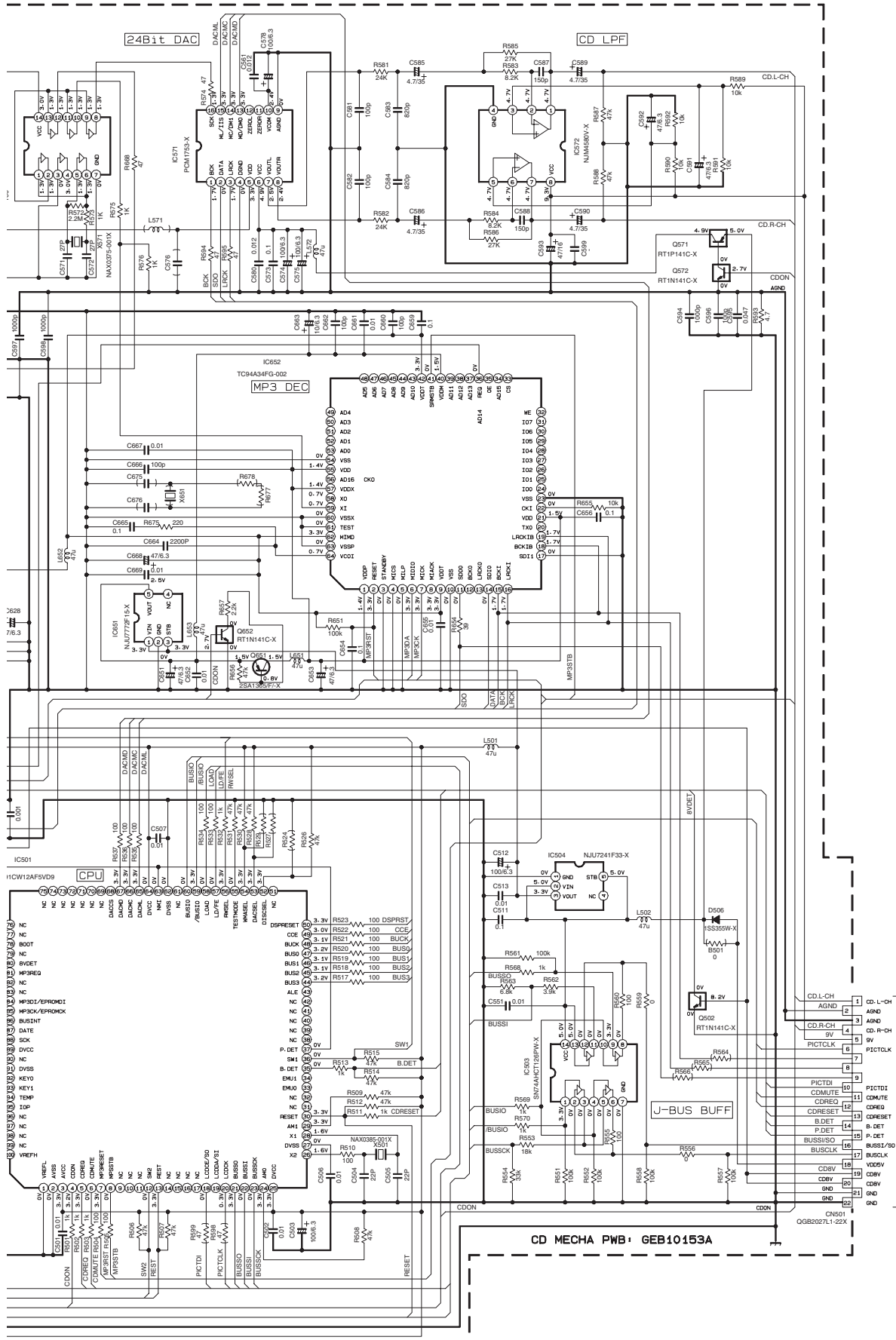

TO CN705  
(SHEET 1)

# Cassette mechanism control section (For KW-XC400)

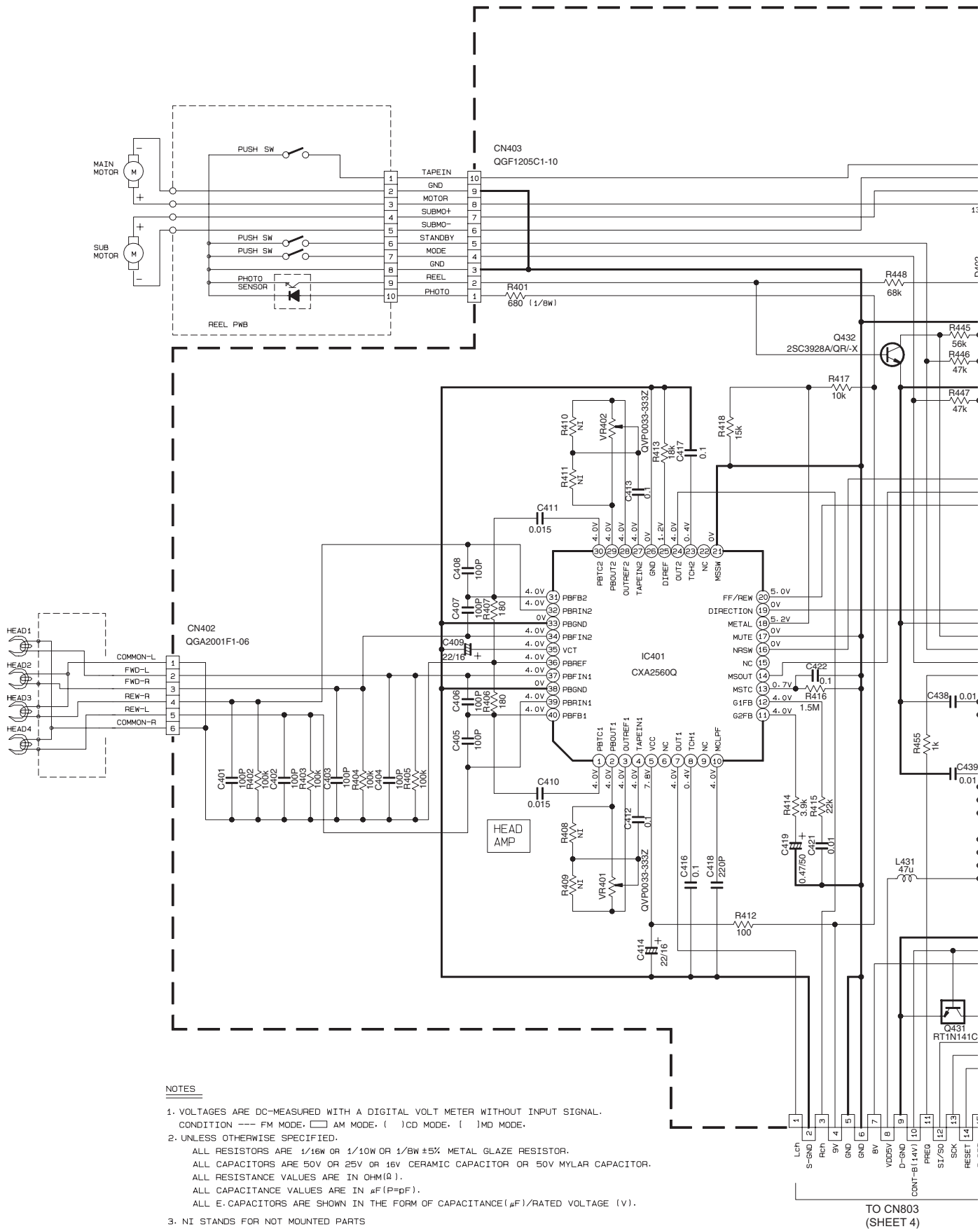

### NOTES

- VOLTAGES ARE DC-MEASURED WITH A DIGITAL VOLT METER WITHOUT INPUT SIGNAL. CONDITION --- FM MODE. □ AM MODE. ( ) CD MODE. [ ] MD MODE.
- UNLESS OTHERWISE SPECIFIED.
  - ALL RESISTORS ARE 1/16W OR 1/10W OR 1/8W ±5% METAL GLAZE RESISTOR.
  - ALL CAPACITORS ARE 50V OR 25V OR 16V CERAMIC CAPACITOR OR 50V MYLAR CAPACITOR.
  - ALL RESISTANCE VALUES ARE IN OHM(Ω).
  - ALL CAPACITANCE VALUES ARE IN μF(P=pF).
  - ALL E. CAPACITORS ARE SHOWN IN THE FORM OF CAPACITANCE(μF)/RATED VOLTAGE (V).
- NI STANDS FOR NOT MOUNTED PARTS

TO CN803 (SHEET 4)



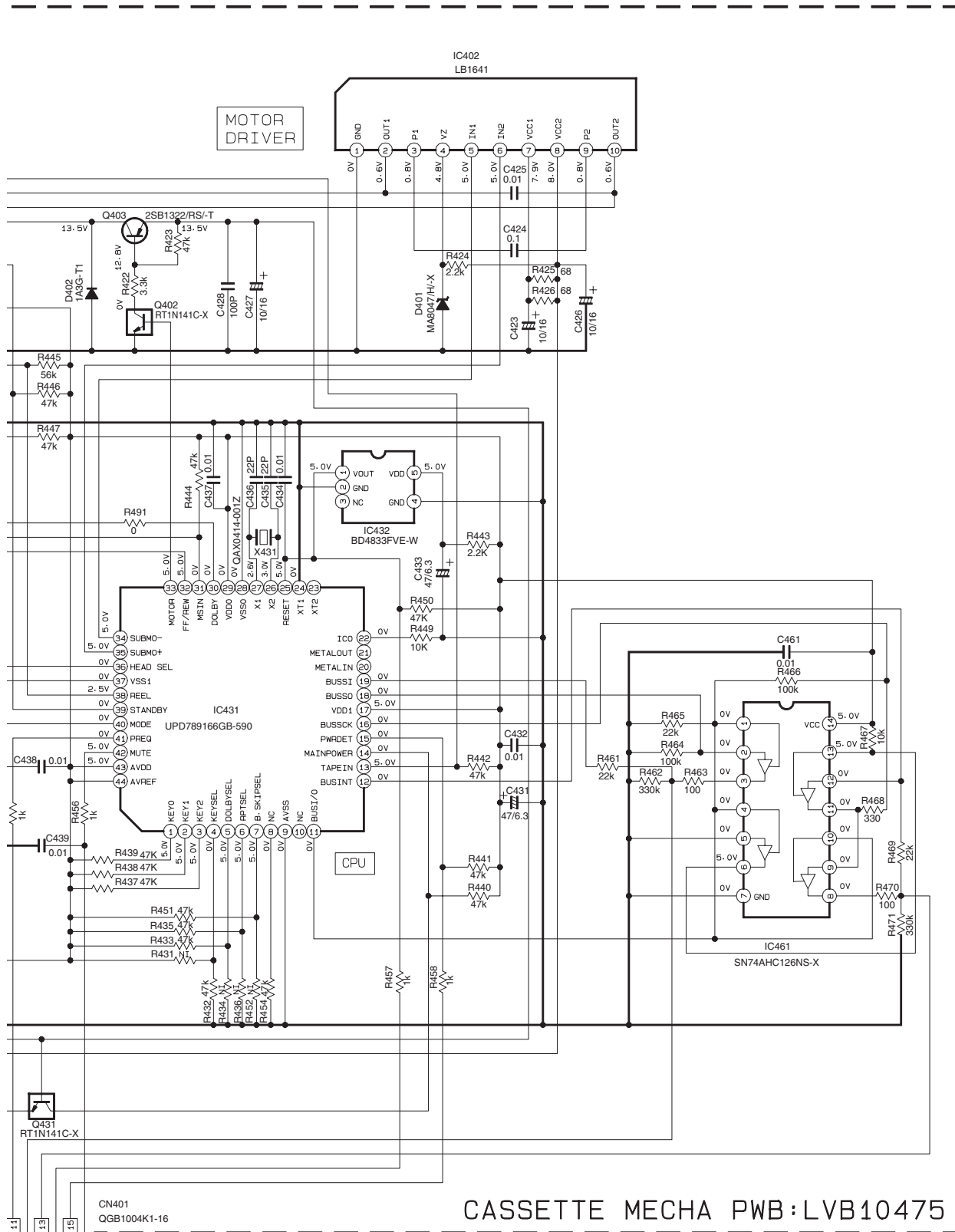

CASSETTE MECHA PWB:LVB10475

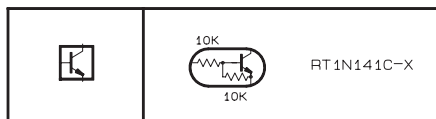



SW PWB:GEB10160A

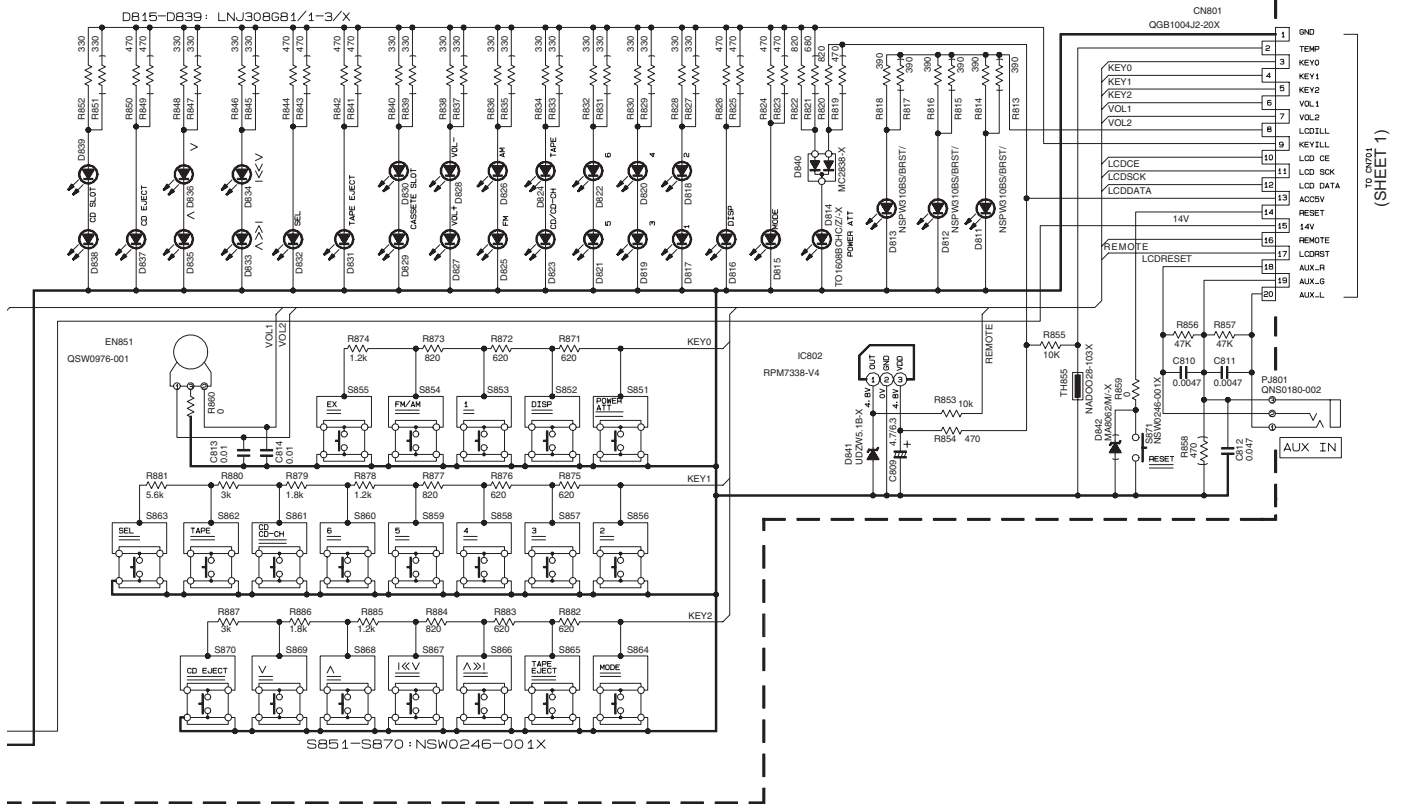

NOTES

- VOLTAGES ARE DC-MEASURED WITH A DIGITAL VOLT METER WITHOUT INPUT SIGNAL.  
CONDITION — FM MODE: [ ] AM MODE: [ ] CD MODE: [ ] TAPE MODE.
- UNLESS OTHERWISE SPECIFIED.  
ALL RESISTORS ARE 1/16W OR 1/10W OR 1/8W ±5% METAL GLAZE RESISTOR.  
ALL CAPACITORS ARE 50V OR 25V OR 16V CERAMIC CAPACITOR OR 50V MYLAR CAPACITOR.  
ALL RESISTANCE VALUES ARE IN OHM(Ω).  
ALL CAPACITANCE VALUES ARE IN μF(μF).  
ALL E-CAPACITORS ARE SHOWN IN THE FORM OF CAPACITANCE(μF)/RATED VOLTAGE (V).
- NI STANDS FOR NOT MOUNTED PARTS

# Main amplifier section (For KW-XC407)

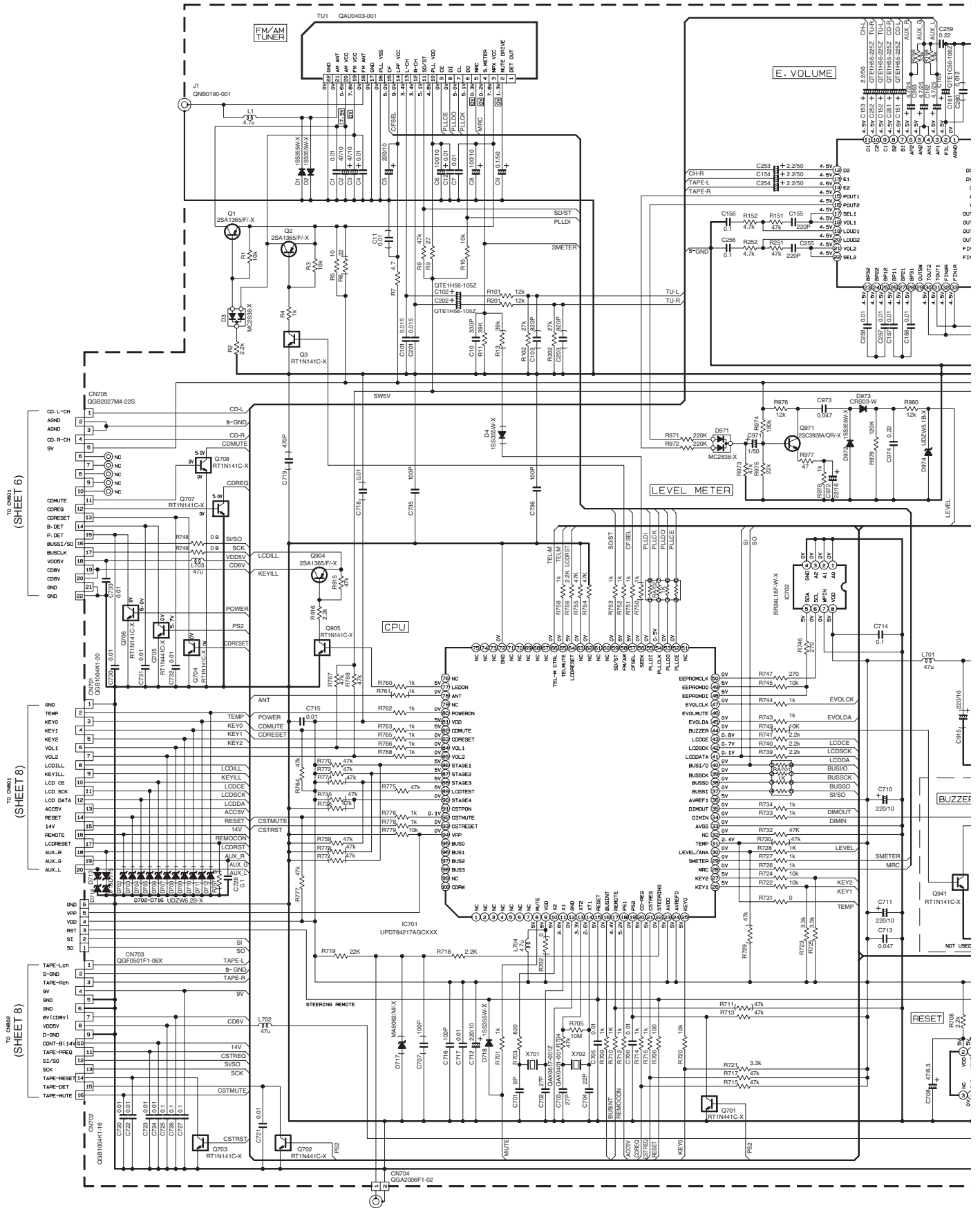

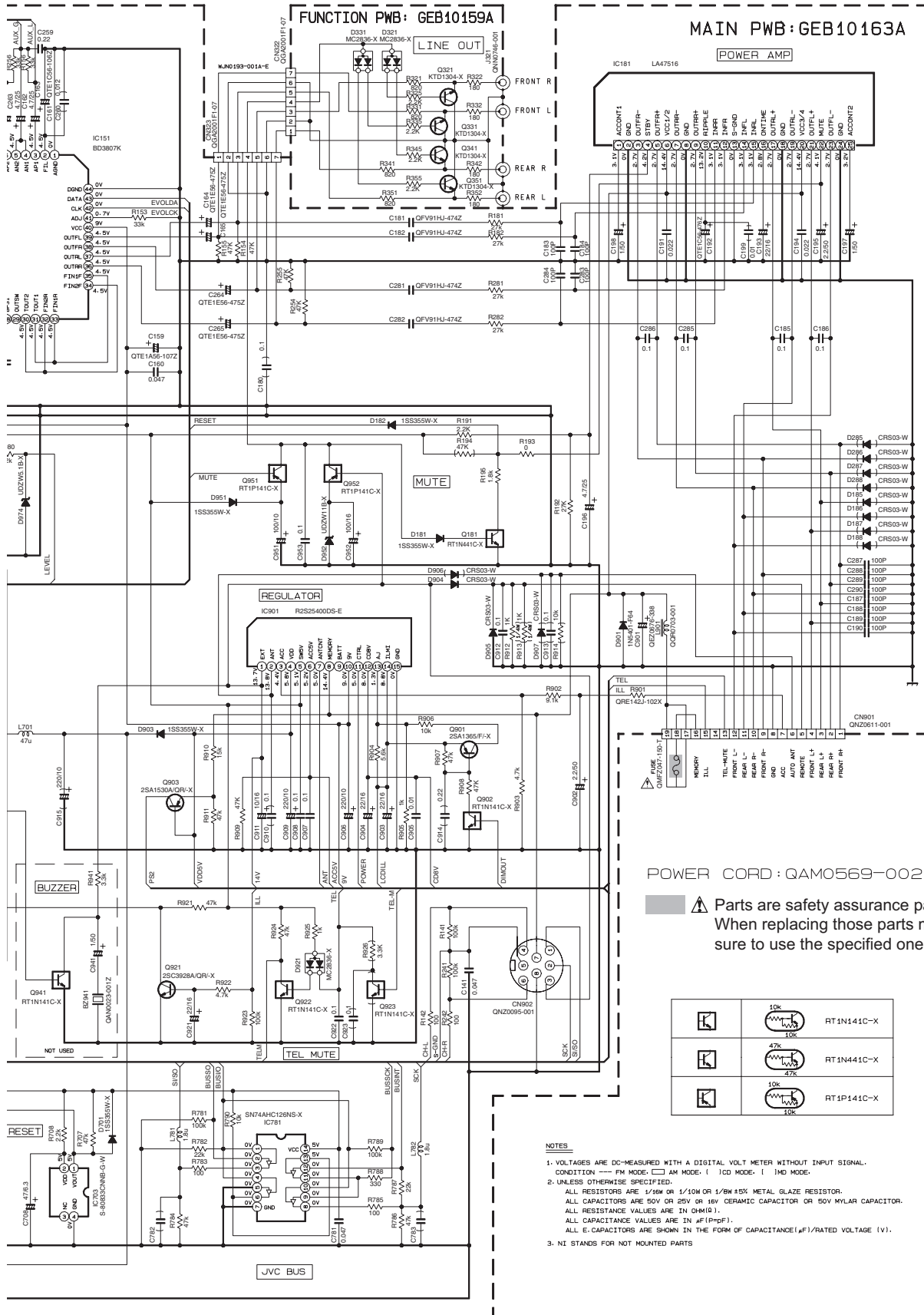

POWER CORD : QAM0569-002

⚠ Parts are safety assurance parts. When replacing those parts make sure to use the specified one.

	10k	RT1N141C-X
	47k	RT1N441C-X
	10k	RT1P141C-X

- NOTES
- VOLTAGES ARE DC-MEASURED WITH A DIGITAL VOLT METER WITHOUT INPUT SIGNAL. CONDITION: FM MODE: [ ] AM MODE: [ ] CD MODE: [ ] MD MODE: [ ]
  - UNLESS OTHERWISE SPECIFIED, ALL RESISTORS ARE 1/16W OR 1/10W OR 1/8W 45% METAL GLAZE RESISTOR. ALL CAPACITORS ARE 50V OR 25V OR 16V CERAMIC CAPACITOR OR 50V NYLON CAPACITOR. ALL RESISTANCE VALUES ARE IN OHM(Ω). ALL CAPACITANCE VALUES ARE IN μF(PpF). ALL E-CAPACITORS ARE SHOWN IN THE FORM OF CAPACITANCE(μF)/RATED VOLTAGE (V).
  - NI STANDS FOR NOT MOUNTED PARTS

# CD servo control section (For KW-XC407)

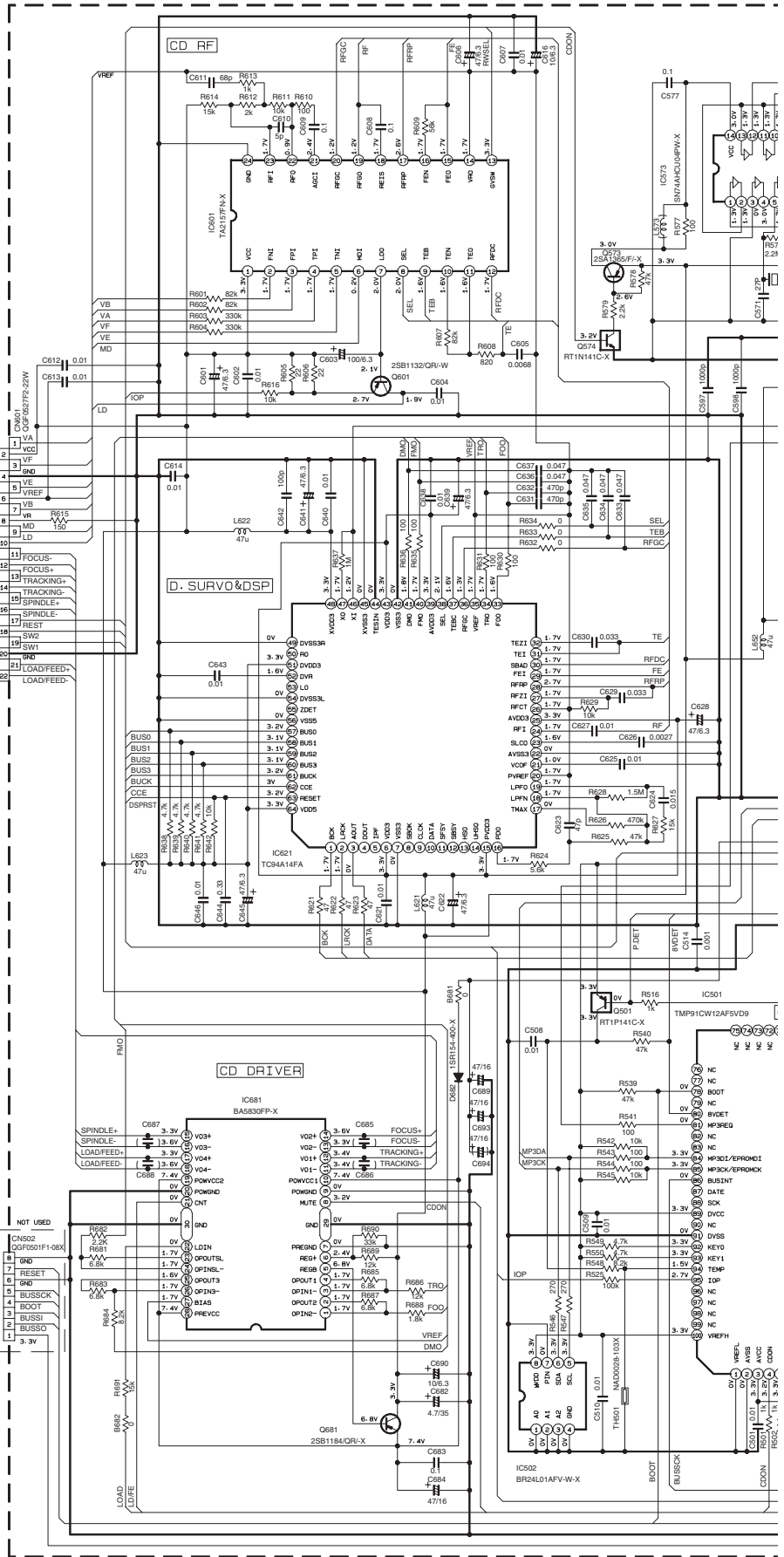
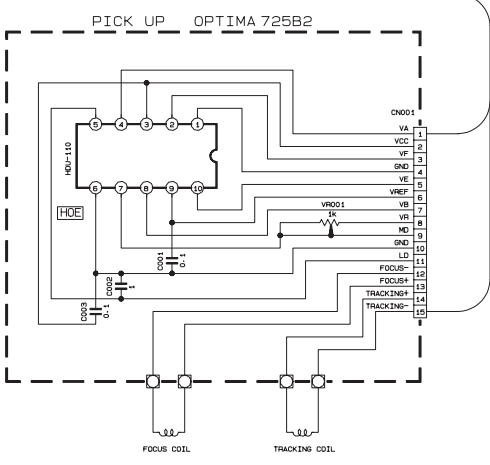
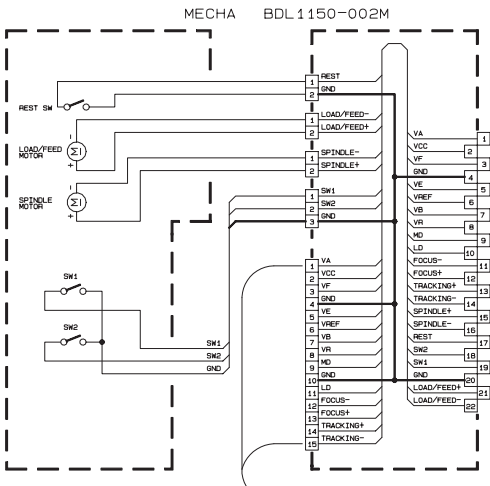

- NOTES**
- VOLTAGES ARE DC-MEASURED WITH A DIGITAL VOLT METER WITHOUT INPUT SIGNAL. CONDITION --- CD MODE.
  - UNLESS OTHERWISE SPECIFIED, ALL RESISTORS ARE 1/10W OR 1/8W OR 1/4W ±5% METAL GLAZE RESISTOR. ALL CAPACITORS ARE 50V OR 25V OR 16V CERAMIC CAPACITOR OR 50V MYLAR CAPACITOR. ALL RESISTANCE VALUES ARE IN Ω(MΩ).
  - ALL CAPACITANCE VALUES ARE IN μF(pF).
  - ALL CAPACITANCE VALUES ARE SHOWN IN THE FORM OF CAPACITANCE(μF)/RATED VOLTAGE (V).
  - COMPONENTS IN ( ) INDICATE NOT USE.

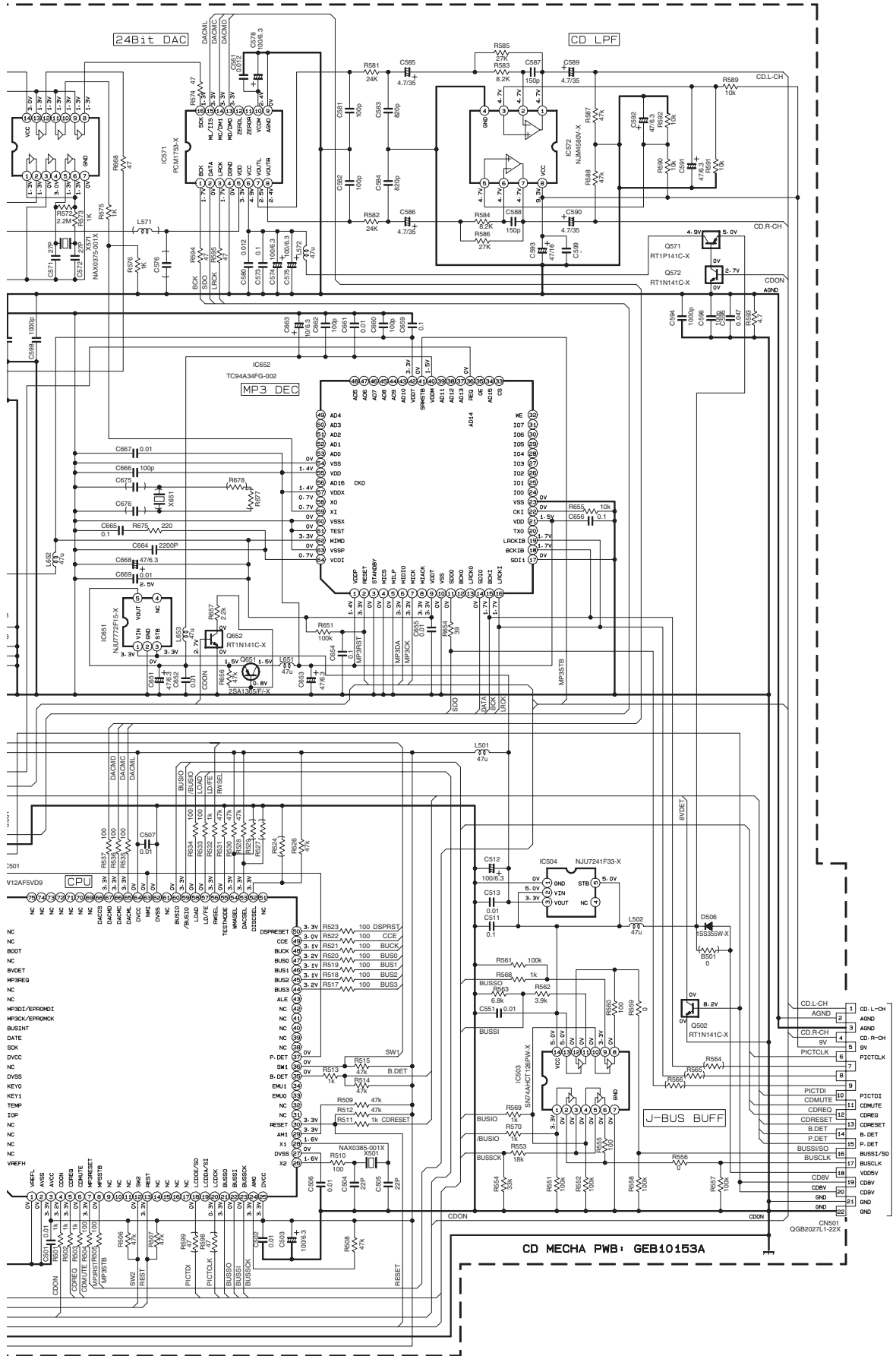

TO CN705  
(SHEET 5)

# ■ Cassette mechanism control section (For KW-XC407)

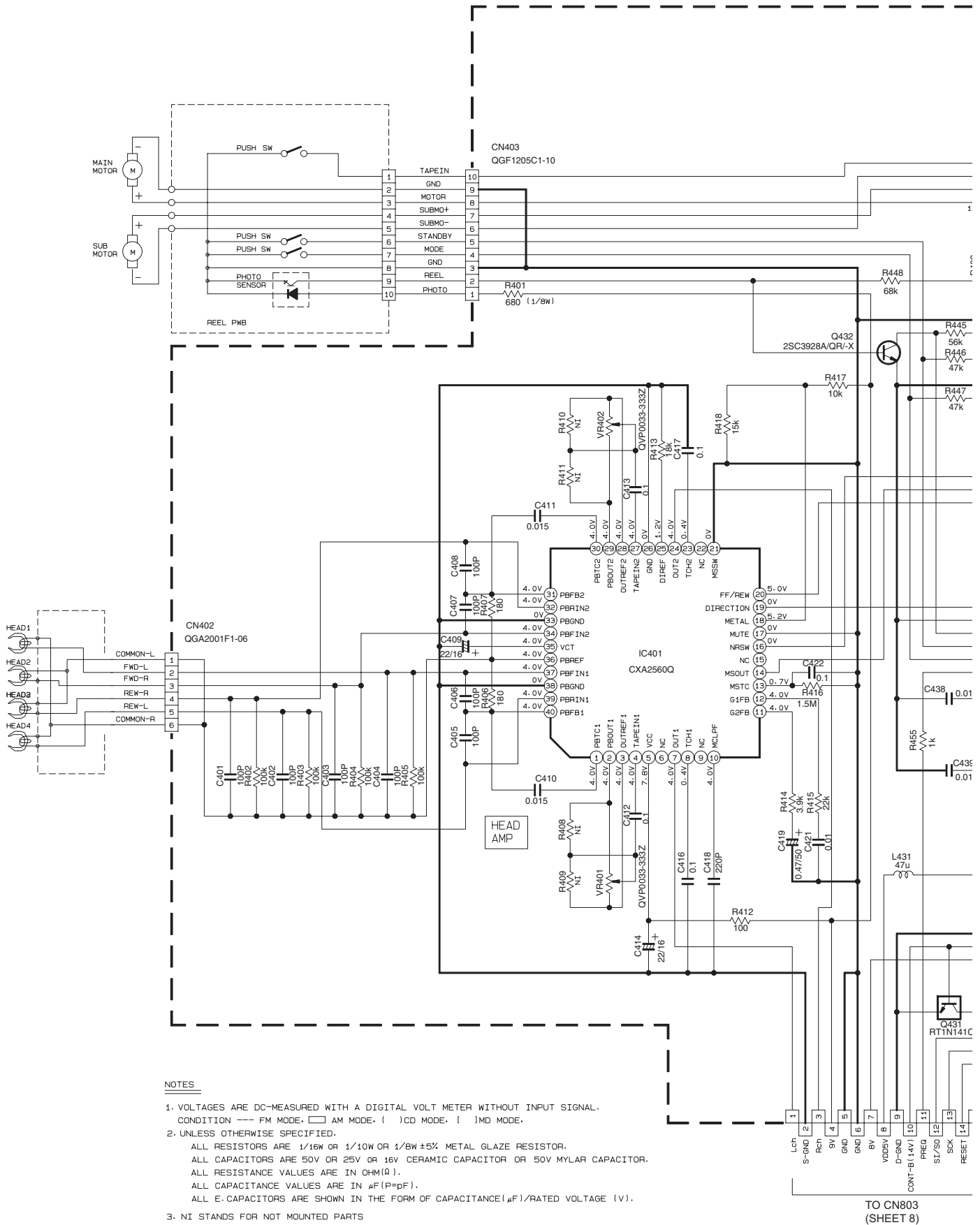

### NOTES

1. VOLTAGES ARE DC-MEASURED WITH A DIGITAL VOLT METER WITHOUT INPUT SIGNAL.  
 CONDITION --- FM MODE, □ AM MODE, ( ) CD MODE, [ ] MD MODE.
2. UNLESS OTHERWISE SPECIFIED.  
 ALL RESISTORS ARE 1/16W OR 1/10W OR 1/8W ±5% METAL GLAZE RESISTOR.  
 ALL CAPACITORS ARE 50V OR 25V OR 16V CERAMIC CAPACITOR OR 50V MYLAR CAPACITOR.  
 ALL RESISTANCE VALUES ARE IN OHM(Ω).  
 ALL CAPACITANCE VALUES ARE IN μF(P=pF).  
 ALL E-CAPACITORS ARE SHOWN IN THE FORM OF CAPACITANCE(μF)/RATED VOLTAGE (V).
3. NI STANDS FOR NOT MOUNTED PARTS

TO CN803  
(SHEET 8)



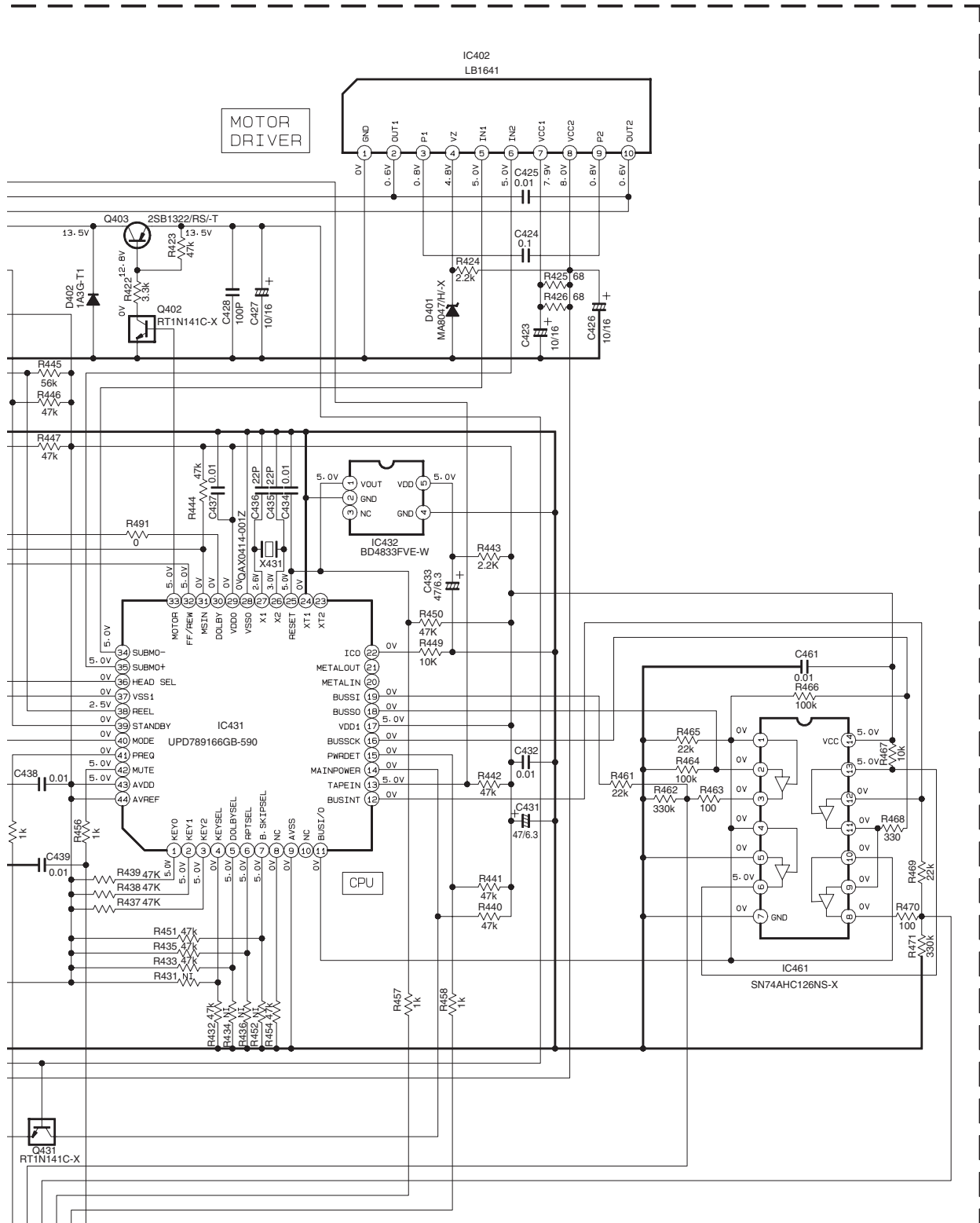

CASSETTE MECHA PWB:LVB10475

- 11 PREG
- 12 SL/SO
- 13 SCK
- 14 RESET
- 15 P.DET
- 16 A.MUTE

CN401  
QGB1004K1-16

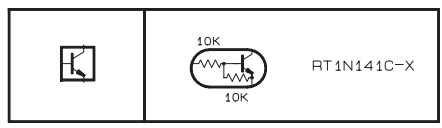

# LCD and user control keys section (For KW-XC407)

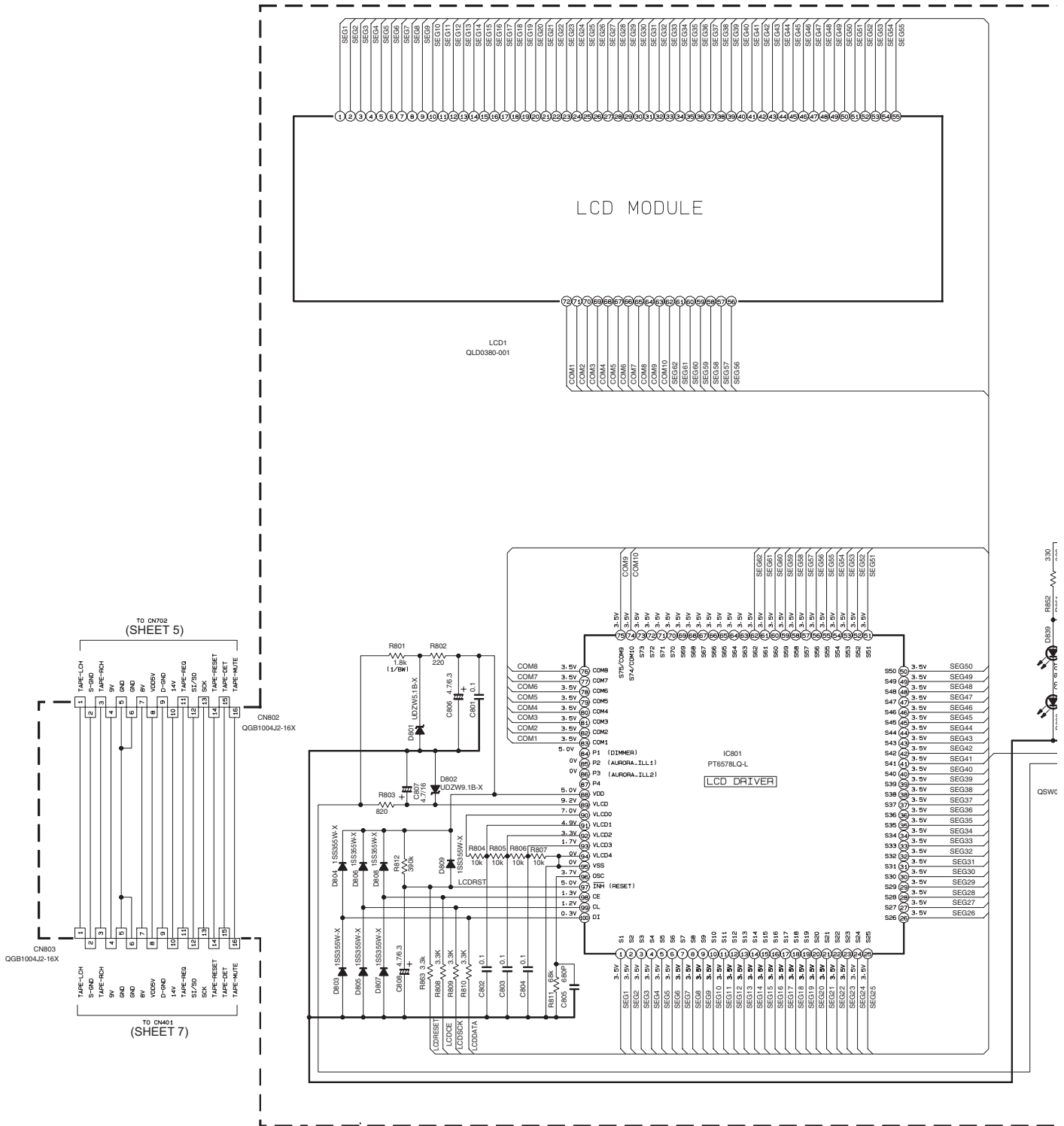

- NOTES
1. VOLTAGES AT CONDITION
  2. UNLESS OTH ALL REST ALL CAPA ALL REST ALL CAPA ALL E. CA
  3. NI STANDS

SW PWB: GEB10160A

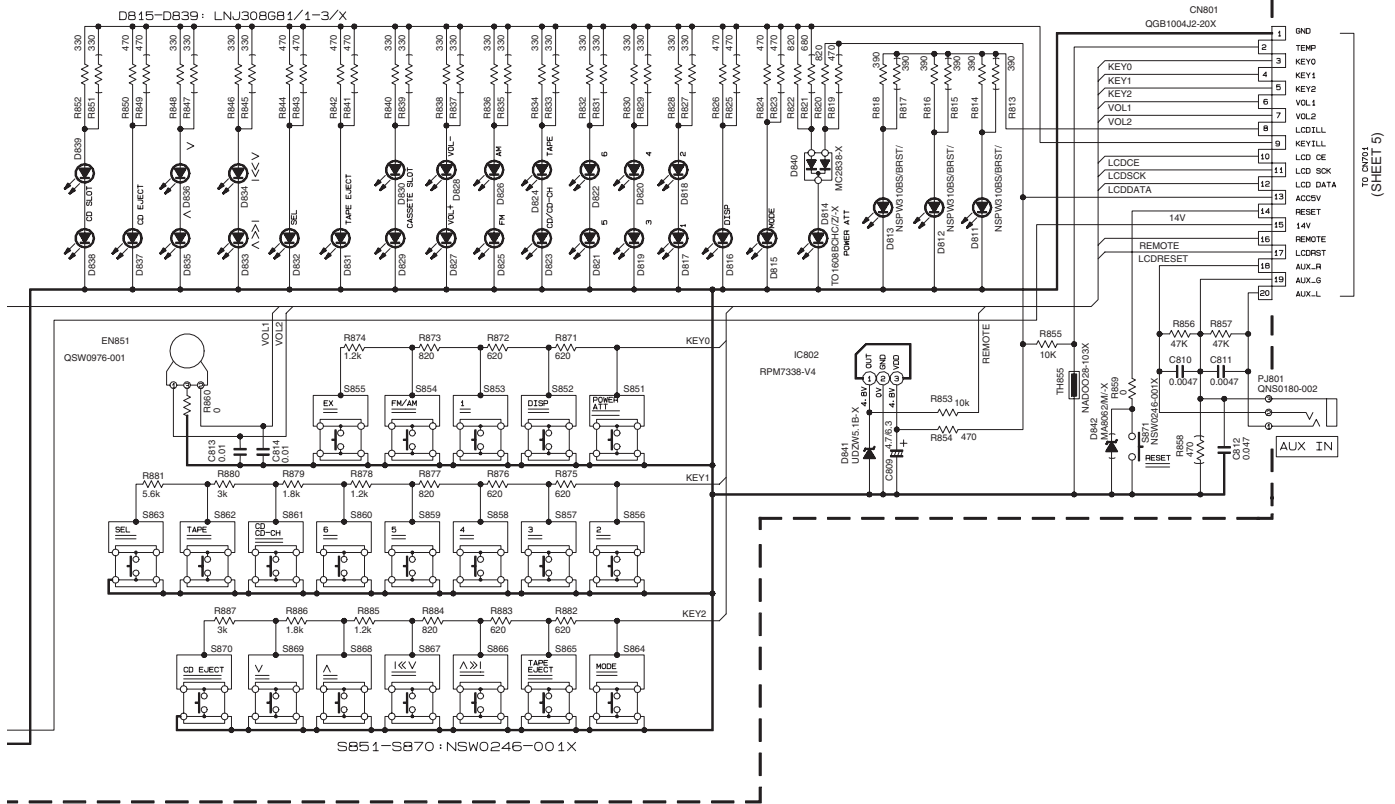

NOTES

- VOLTAGES ARE DC-MEASURED WITH A DIGITAL VOLT METER WITHOUT INPUT SIGNAL. CONDITION — FM MODE; □ AM MODE; ( ) CD MODE; { } TAPE MODE.
- UNLESS OTHERWISE SPECIFIED, ALL RESISTORS ARE 1/16W OR 1/10W OR 1/8W ±5% METAL GLAZE RESISTOR. ALL CAPACITORS ARE 50V OR 75V OR 85V CERAMIC CAPACITOR OR 50V MYLAR CAPACITOR. ALL RESISTANCE VALUES ARE IN OHM(Ω). ALL CAPACITANCE VALUES ARE IN #F(PPF). ALL E. CAPACITORS ARE SHOWN IN THE FORM OF CAPACITANCE(#F1)/RATED VOLTAGE (V).
- NI STANDS FOR NOT MOUNTED PARTS





■ **Function board** Lead free solder used in the board (material : Sn-Ag-Cu, melting point : 219 Centigrade)

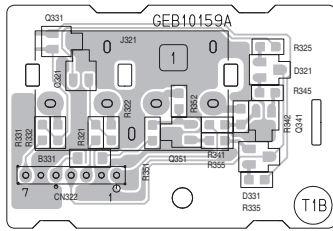

■ **Switch board** Lead free solder used in the board (material : Sn-Ag-Cu, melting point : 219 Centigrade)

Forward side

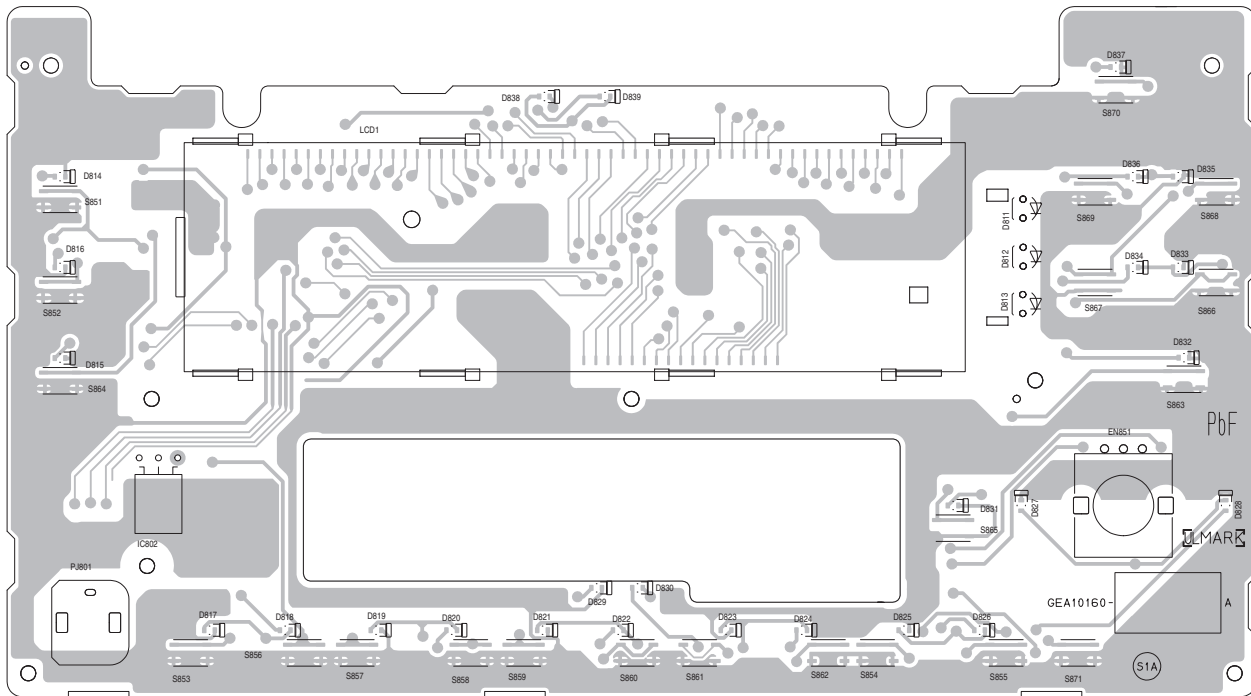

Reverse side

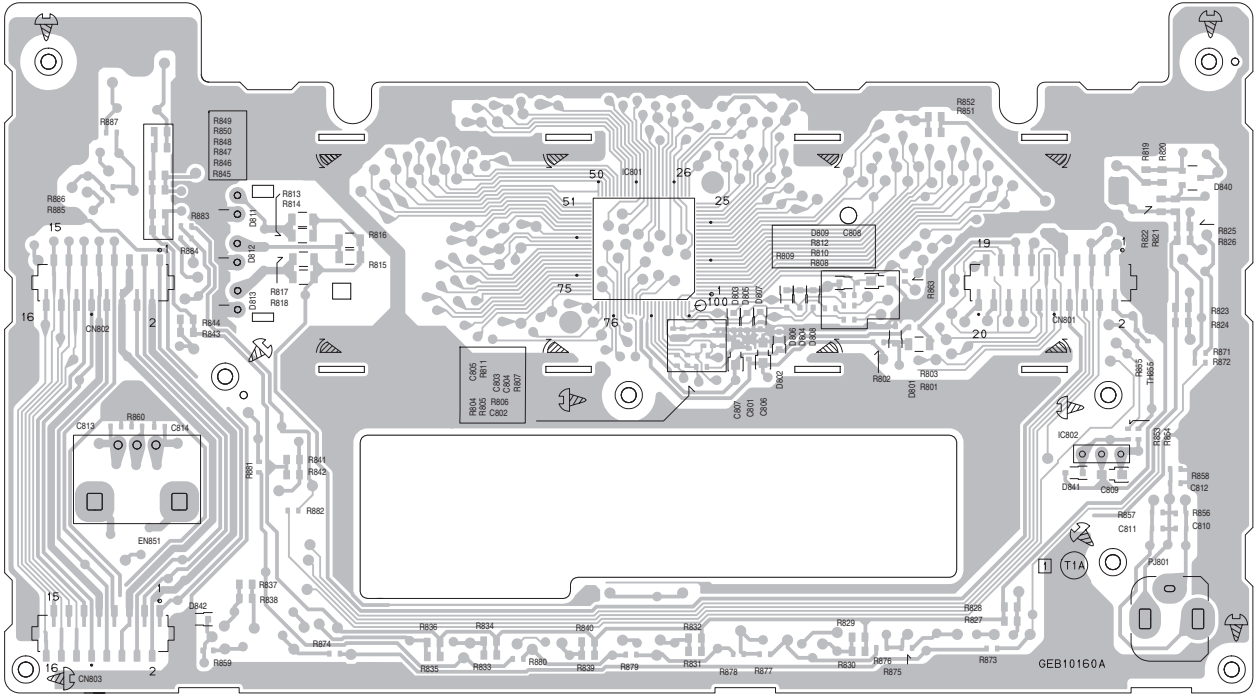

## CD servo control board

Lead free solder used in the board (material : Sn-Ag-Cu, melting point : 219 Centigrade)

Forward side

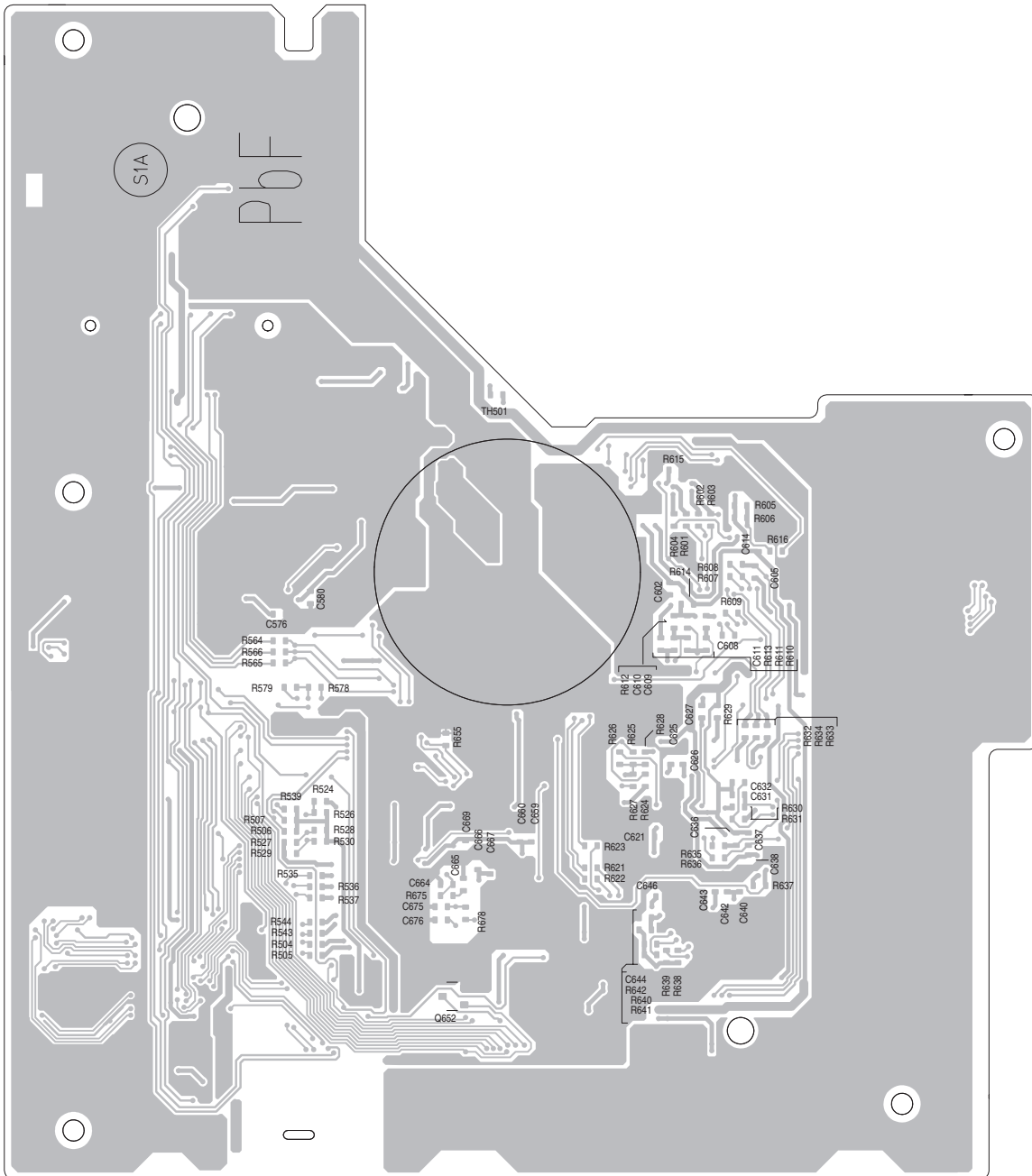





## ■ Cassette mechanism control board

Lead free solder used in the board (material : Sn-Ag-Cu, melting point : 219 Centigrade)

Forward side

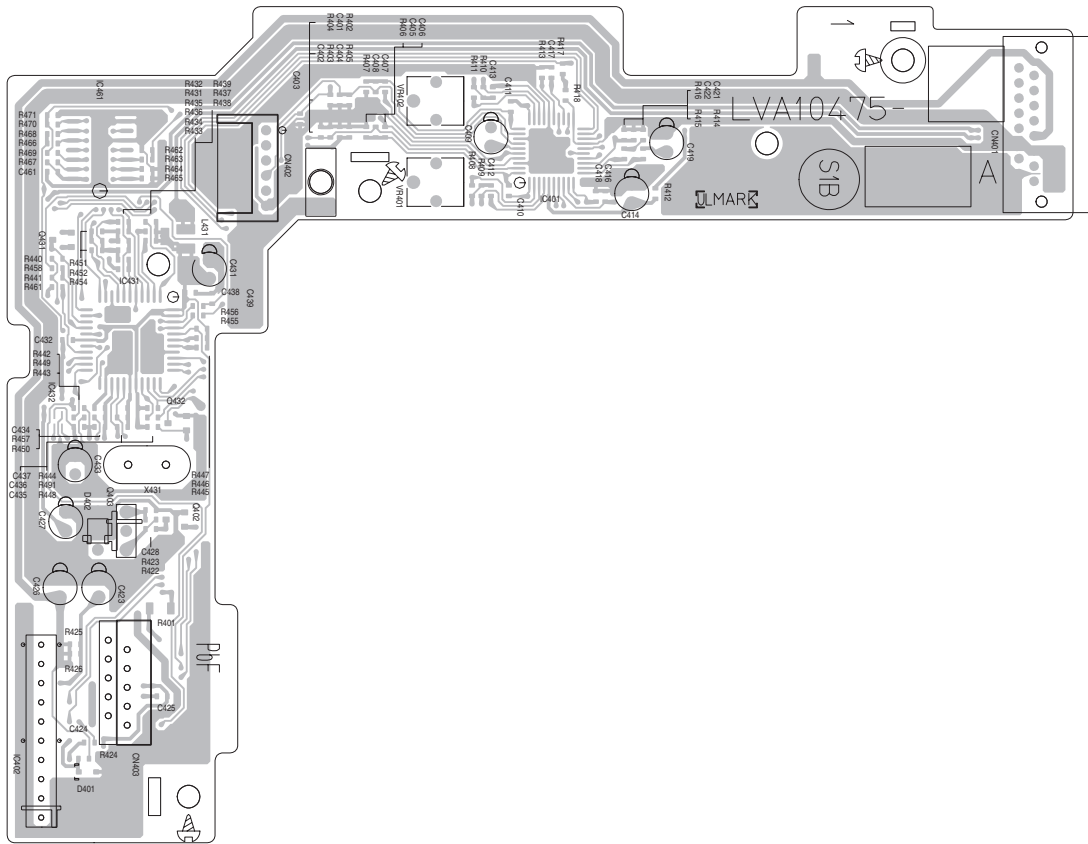

Reverse side

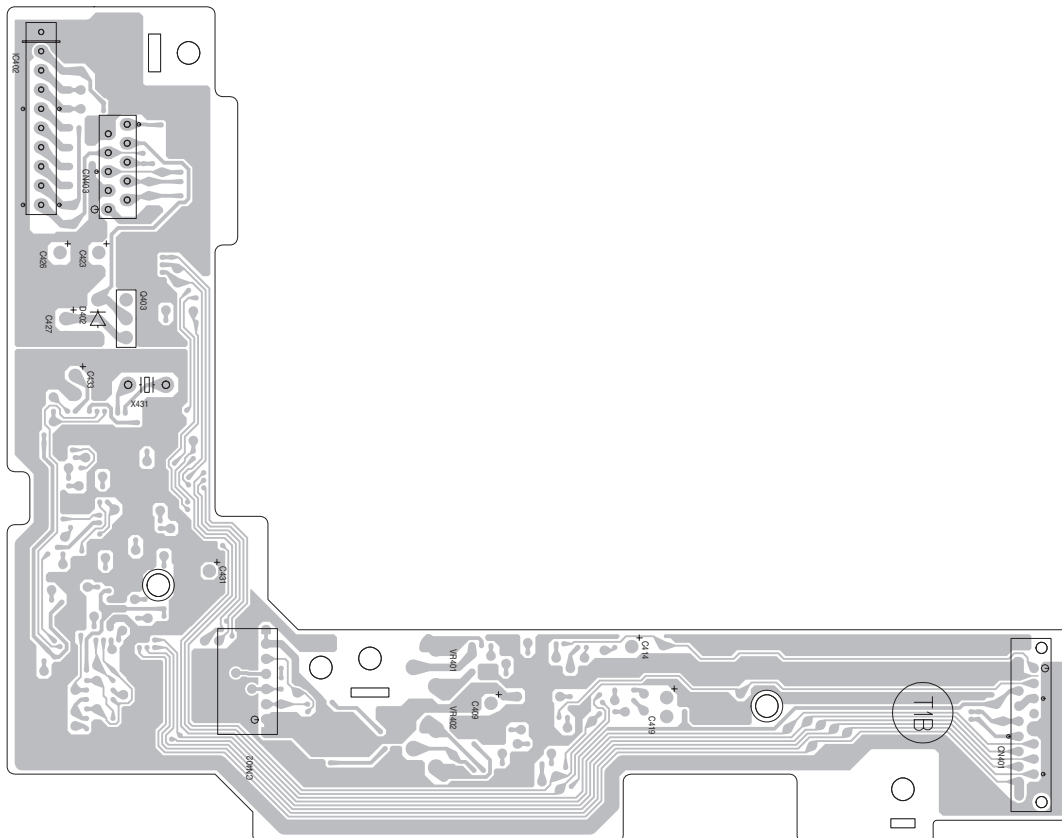

< MEMO >

**JVC**

Victor Company of Japan, Limited

Mobile Entertainment Business Group Mobile Entertainment Category 10-1,1chome,Ohwatari-machi,Maebashi-city,371-8543,Japan

(No.MA235SCH)



Printed in Japan  
VPT

# PARTS LIST

[ KW-XC400] [ KW-XC407]

\* All printed circuit boards and its assemblies are not available as service parts.

## **KW-XC400**

Area suffix

J ----- Northern America

## **KW-XC407**

Area suffix

EE ----- Russian Federation

### - Contents -

Exploded view of general assembly and parts list (Block No.M1) .....	3-2
Electrical parts list (Block No.01~05)(KW-XC400) .....	3-6
Electrical parts list (Block No.06~10)(KW-XC407) .....	3-12
Packing materials and accessories parts list (Block No.M3) .....	3-20

# Exploded view of general assembly and parts list

Block No. M 1 M M

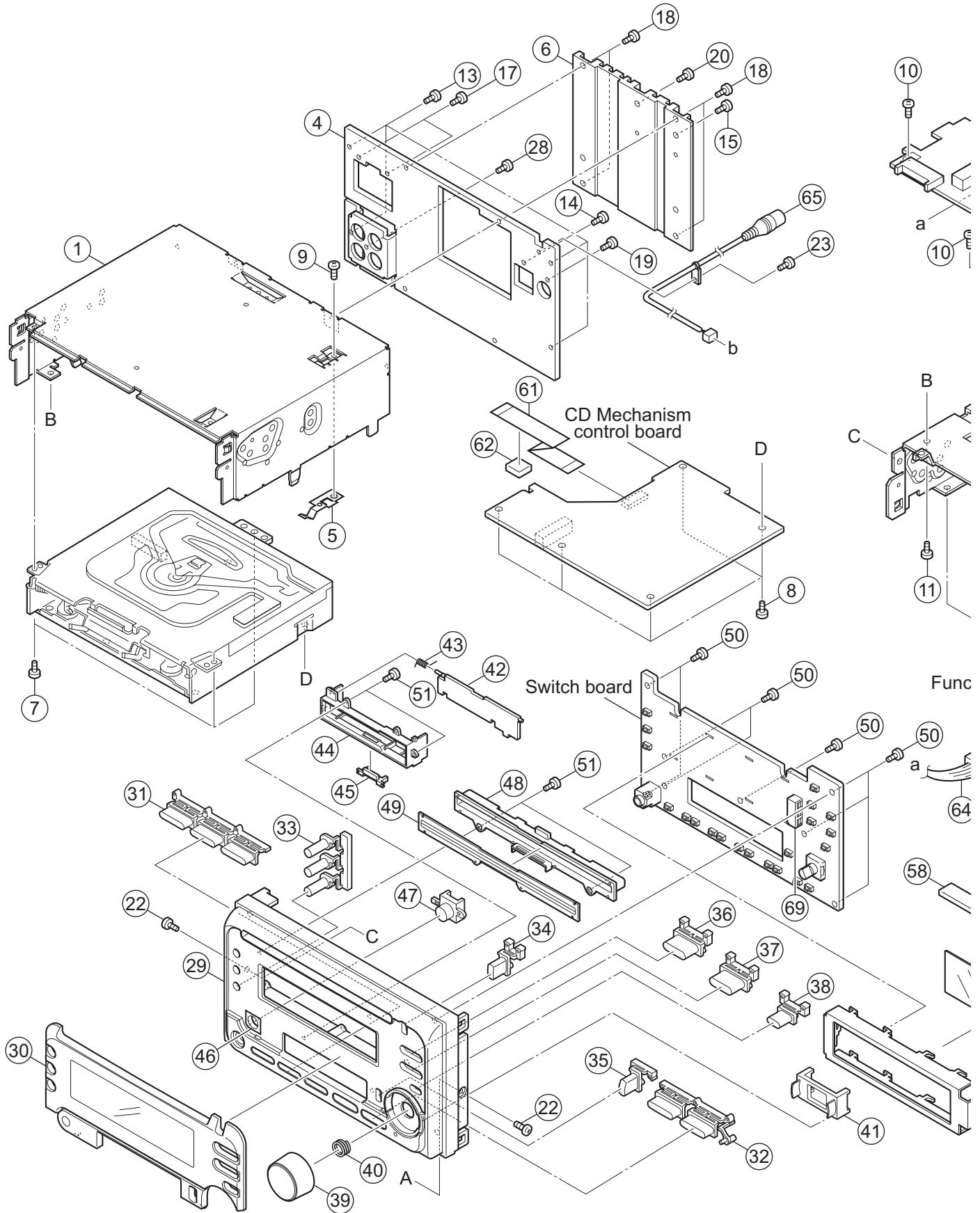

M

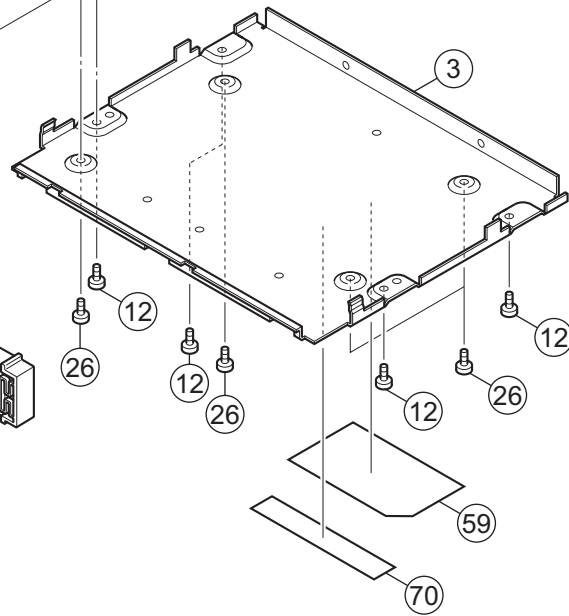
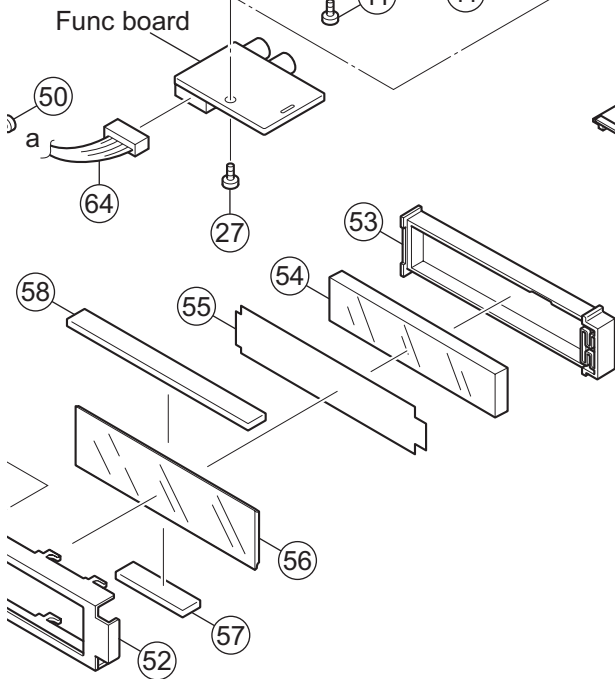
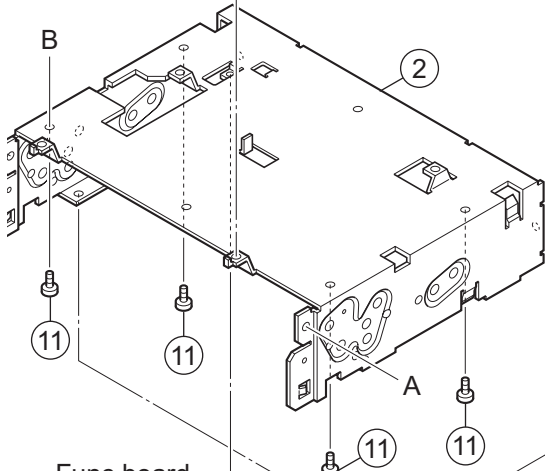
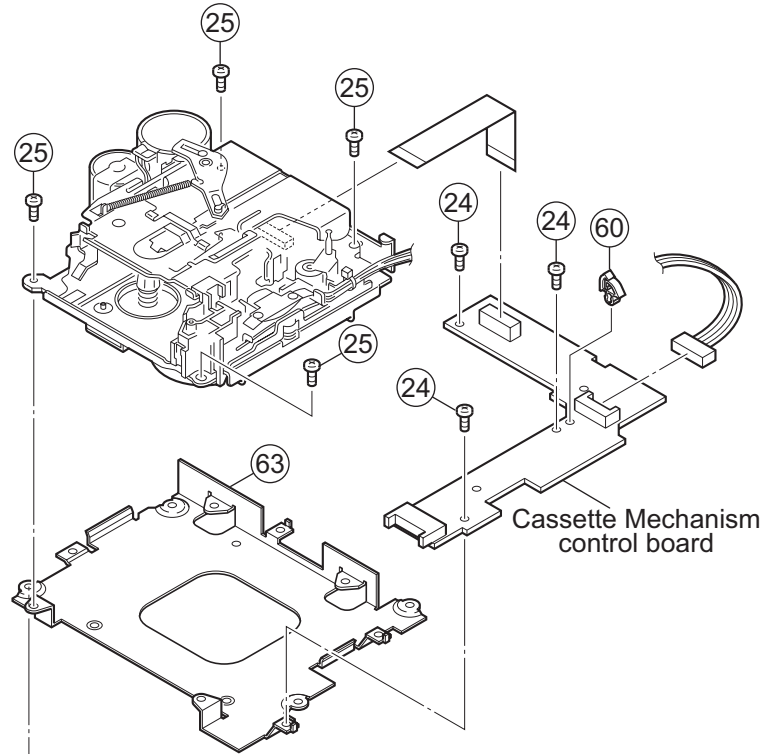
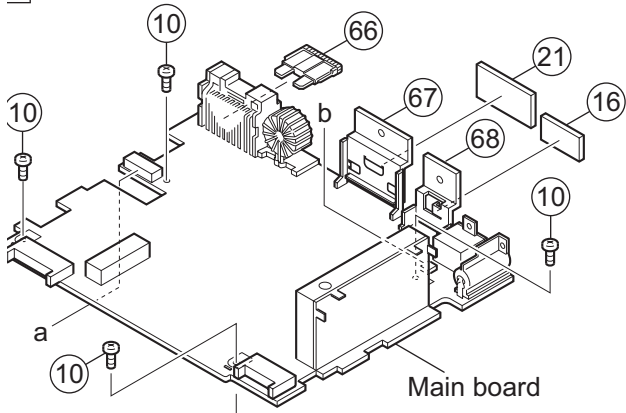

# General Assembly

Block No. [M][1][M][M]

△	Symbol No.	Part No.	Part Name	Description	Local
	1	LV10863-001A	TOP CHASSIS		
	2	LV10864-002A	MIDDLE CHASSIS		
	3	LV10865-001A	BOTTOM CHASSIS		
	4	GE31799-001A	REAR BRACKET		
	5	LV34654-001A	EARTH PLATE		
	6	LV34655-001A	HEAT SINK		
	7	QYSDST2604ZA	TAP SCREW	M2.6 x 4mm(x3)	
	8	QYSDST2004ZA	TAP SCREW	M2 x 4mm(x5)	
	9	QYSDST2606ZA	TAP SCREW	M2.6 x 6mm	
	10	GE40235-004A	SCREW	(x4)	
	11	QYSDST2606ZA	TAP SCREW	M2.6 x 6mm(x4)	
	12	QYSDST2606ZA	TAP SCREW	M2.6 x 6mm(x4)	
	13	QYSDST2606ZA	TAP SCREW	M2.6 x 6mm(x4)	
	14	QYSDST2606ZA	TAP SCREW	M2.6 x 6mm	
	15	QYSDST2606ZA	TAP SCREW	M2.6 x 6mm	
	16	LV43693-001A	COOLING RUBBER		
	17	QYSDSF2606ZA	TAP SCREW	M2.6 x 6mm(x2)	
	18	QYSDST2606ZA	TAP SCREW	M2.6 x 6mm(x4)	
	19	QYSDST2606ZA	TAP SCREW	M2.6 x 6mm	
	20	QYSDST2606ZA	TAP SCREW	M2.6 x 6mm	
	21	LV43694-001A	COOLING RUBBER		
	22	QYSDST2004ZA	TAP SCREW	M2 x 4mm(x2)	
	23	QYSDST2606ZA	TAP SCREW	M2.6 x 6mm	
	24	QYSDST2606ZA	TAP SCREW	M2.6 x 6mm(x3)	
	25	QYSDST2606ZA	TAP SCREW	M2.6 x 6mm(x4)	
	26	QYSDST2606ZA	TAP SCREW	M2.6 x 6mm(x4)	
	27	QYSDST2606ZA	TAP SCREW	M2.6 x 6mm	
	28	QYSDSF3006ZA	TAP SCREW	M3 x 6mm	
	29	GE10129-008A	FRONT PANEL		400J
	29	GE10129-006A	FRONT PANEL		407EE
	30	GE31801-006A	FINDER ASSY		400J
	30	GE31801-009A	FINDER ASSY		407EE
	31	GE31768-001A	PRESET BUTTON		400J
	31	GE31768-002A	PRESET BUTTON		407EE
	32	GE31769-001A	D FUNCTION BTN		400J
	32	GE31769-002A	D FUNCTION BTN		407EE
	33	GE31778-001A	BLOCK BUTTON		400J
	33	GE31778-002A	BLOCK BUTTON		407EE
	34	GE31779-001A	BUTTON(CDEJ)		400J
	34	GE31779-002A	BUTTON(CDEJ)		407EE
	35	GE31780-001A	CASS EJECT BTN		400J
	35	GE31780-002A	CASS EJECT BTN		407EE
	36	GE31781-001A	BUTTON(GROUP)		400J
	36	GE31781-002A	BUTTON(GROUP)		407EE
	37	GE31782-001A	SEEK BUTTON		400J
	37	GE31782-002A	SEEK BUTTON		407EE
	38	GE31783-001A	DISP BUTTON		400J
	38	GE31783-002A	DISP BUTTON		407EE
	39	GE31763-001A	VOLUME KNOB		400J
	39	GE31763-002A	VOL KNOB		407EE
	40	GE40127-001A	KNOB SPRING		
	41	GE31770-001A	RIM LENS		
	42	GE31775-001A	CASS.LID		
	43	VKW5312-001	DOOR SPRING		
	44	GE31767-001A	CASS.GUIDE		
	45	GE40288-001A	CASSETTE LENS		
	46	GE40291-001A	REMOTE SHEET		400J
	47	GE40295-001A	REMOTE LENS		
	48	LV34662-001A	DISC GUIDE		
	49	LV34709-001A	BLIND		
	50	VKZ4777-010	MINI SCREW	(x8)	
	51	VKZ4777-011	MINI SCREW	(x4)	
	52	GE31771-001A	LCD CASE		
	53	GE31772-001A	LENS CASE		
	54	GE31773-001A	LCD LENS		
	55	GE40285-001A	LIGHTING SHEET		
	56	QLD0380-001	LCD MODULE		
	57	QNZ0817-001	RUBBER CONNECTO		
	58	QNZ0818-001	RUBBER CONNECTO		
	59	GE32001-002A	NAME PLATE		400J
	59	GE32003-002A	NAME PLATE		407EE
	60	QZW0143-001	WIRE CLAMP		
	61	QUQL05-2207AE-E	FFC WIRE	22pin 7cm	
	62	VYSH101-009	SPACER		



△	Symbol No.	Part No.	Part Name	Description	Local
	63	LV21628-001A	CS MECHA BKT		
	64	WJN0193-001A-E	E-SH C WIRE C-C		
	65	QAM0686-001	STEERING REMOTE		
△	66	QMFZ047-150-T	FUSE	15A	
	67	LV34650-001A	IC BKT		
	68	LV34651-001A	REG BKT		
	69	GE31774-001A	LED HOLDER		
	70	LV41843-002A	LASER CAUTION		407EE

# Electrical parts list

## Main board (KW-XC400\_J)

Block No. [0][1]

△ Symbol No.	Part No.	Part Name	Description	Local
IC151	BD3807K	IC		
IC181	LA47516	POWER IC		
IC701	UPD784217AGC358	IC		
IC702	BR24L16F-W-X	IC		
IC703	S-80833CNNB-G-W	IC		
IC781	SN74AHC126NS-X	IC		
IC901	R2S25400DS-E	REGULATOR IC		
Q1	2SA1365/F/-X	TRANSISTOR		
Q2	2SA1365/F/-X	TRANSISTOR		
Q3	RT1N141C-X	DIGI TRANSISTOR		
Q181	RT1N441C-X	TRANSISTOR		
Q701	RT1N441C-X	TRANSISTOR		
Q702	RT1N441C-X	TRANSISTOR		
Q703	RT1N141C-X	DIGI TRANSISTOR		
Q704	RT1N141C-X	DIGI TRANSISTOR		
Q705	RT1N441C-X	TRANSISTOR		
Q706	RT1N141C-X	DIGI TRANSISTOR		
Q707	RT1N141C-X	DIGI TRANSISTOR		
Q708	RT1N141C-X	DIGI TRANSISTOR		
Q901	2SA1365/F/-X	TRANSISTOR		
Q902	RT1N141C-X	DIGI TRANSISTOR		
Q903	2SA1530A/QR/-X	TRANSISTOR		
Q904	2SA1365/F/-X	TRANSISTOR		
Q905	RT1N141C-X	DIGI TRANSISTOR		
Q921	2SC3928A/QR/-X	TRANSISTOR		
Q951	RT1P141C-X	DIGI TRANSISTOR		
Q952	RT1P141C-X	DIGI TRANSISTOR		
Q971	2SC3928A/QR/-X	TRANSISTOR		
D1	1SS355W-X	DIODE C.M		
D2	1SS355W-X	DIODE C.M		
D3	MC2838-X	DIODE		
D181	1SS355W-X	DIODE C.M		
D182	1SS355W-X	DIODE C.M		
D701	1SS355W-X	DIODE C.M		
D713	UDZW6.2B-X	DIODE		
D714	UDZW6.2B-X	DIODE		
D715	UDZW6.2B-X	DIODE		
D716	UDZW6.2B-X	DIODE		
D718	1SS355W-X	DIODE C.M		
D901	1N5401-F64	DIODE		
D903	1SS355W-X	DIODE C.M		
D904	CRS03-W	SB DIODE		
D905	CRS03-W	SB DIODE		
D951	1SS355W-X	DIODE C.M		
D952	UDZW11B-X	Z DIODE		
D971	MC2838-X	DIODE		
D972	1SS355W-X	DIODE C.M		
D973	CRS03-W	SB DIODE		
D974	UDZW5.1B-X	SI DIODE		
C1	NCB31HK-103X	C CAPACITOR	0.01uF 50V K	
C2	QERF1AM-476Z	E CAPACITOR	47uF 10V M	
C3	QERF1AM-476Z	E CAPACITOR	47uF 10V M	
C4	NCB31HK-103X	C CAPACITOR	0.01uF 50V K	
C5	QERF1AM-227Z	E CAPACITOR	220uF 10V M	
C6	QERF1AM-107Z	E CAPACITOR	100uF 10V M	
C7	NCB31HK-103X	C CAPACITOR	0.01uF 50V K	
C8	QERF1AM-107Z	E CAPACITOR	100uF 10V M	
C9	QERF1HM-104Z	E CAPACITOR	0.1uF 50V M	
C10	NCS31HJ-331X	C CAPACITOR	330pF 50V J	
C12	NCB31HK-103X	C CAPACITOR	0.01uF 50V K	
C101	NCB31HK-223X	C CAPACITOR	0.022uF 50V K	
C102	QTE1H56-105Z	E CAPACITOR	1uF 50V	
C141	NCB31CK-473X	C CAPACITOR	0.047uF 16V K	
C151	QTE1H55-225Z	E CAPACITOR	2.2uF 50V	
C152	QTE1H56-225Z	E CAPACITOR	2.2uF 50V	
C153	QERF1HM-225Z	E CAPACITOR	2.2uF 50V M	
C154	QERF1HM-225Z	E CAPACITOR	2.2uF 50V M	
C155	NCB31HK-221X	C CAPACITOR	220pF 50V K	
C156	NCB31CK-104X	C CAPACITOR	0.1uF 16V K	

△ Symbol No.	Part No.	Part Name	Description	Local
C157	NCB31HK-103X	C CAPACITOR	0.01uF 50V K	
C158	NCB31HK-103X	C CAPACITOR	0.01uF 50V K	
C159	QTE1A56-107Z	E CAPACITOR	100uF 10V	
C160	NCB31CK-473X	C CAPACITOR	0.047uF 16V K	
C161	QTE1C56-106Z	E CAPACITOR	10uF 16V	
C162	QERF1EM-475Z	E CAPACITOR	4.7uF 25V M	
C163	QERF1EM-475Z	E CAPACITOR	4.7uF 25V M	
C164	QTE1E56-475Z	E CAPACITOR	4.7uF 25V	
C165	QTE1E56-475Z	E CAPACITOR	4.7uF 25V	
C181	QFV91HJ-474Z	MF CAPACITOR	0.47uF 50V J	
C182	QFV91HJ-474Z	MF CAPACITOR	0.47uF 50V J	
C183	NDC31HJ-101X	C CAPACITOR	100pF 50V J	
C184	NDC31HJ-101X	C CAPACITOR	100pF 50V J	
C185	NCB31CK-104X	C CAPACITOR	0.1uF 16V K	
C186	NCB31CK-104X	C CAPACITOR	0.1uF 16V K	
C187	NDC31HJ-101X	C CAPACITOR	100pF 50V J	
C188	NDC31HJ-101X	C CAPACITOR	100pF 50V J	
C189	NDC31HJ-101X	C CAPACITOR	100pF 50V J	
C190	NDC31HJ-101X	C CAPACITOR	100pF 50V J	
C191	NCB31HK-223X	C CAPACITOR	0.022uF 50V K	
C192	QTE1C56-476Z	E CAPACITOR	47uF 16V	
C193	QERF1CM-226Z	E CAPACITOR	22uF 16V M	
C194	NCB31HK-223X	C CAPACITOR	0.022uF 50V K	
C195	QERF1HM-225Z	E CAPACITOR	2.2uF 50V M	
C196	QERF1EM-475Z	E CAPACITOR	4.7uF 25V M	
C197	QERF1HM-105Z	E CAPACITOR	1uF 50V M	
C198	QERF1HM-105Z	E CAPACITOR	1uF 50V M	
C201	NCB31HK-223X	C CAPACITOR	0.022uF 50V K	
C202	QTE1H56-105Z	E CAPACITOR	1uF 50V	
C251	QTE1H55-225Z	E CAPACITOR	2.2uF 50V	
C252	QTE1H56-225Z	E CAPACITOR	2.2uF 50V	
C253	QERF1HM-225Z	E CAPACITOR	2.2uF 50V M	
C254	QERF1HM-225Z	E CAPACITOR	2.2uF 50V M	
C255	NCB31HK-221X	C CAPACITOR	220pF 50V K	
C256	NCB31CK-104X	C CAPACITOR	0.1uF 16V K	
C257	NCB31HK-103X	C CAPACITOR	0.01uF 50V K	
C258	NCB31HK-103X	C CAPACITOR	0.01uF 50V K	
C259	NCB31CK-224X	C CAPACITOR	0.22uF 16V K	
C263	QERF1EM-475Z	E CAPACITOR	4.7uF 25V M	
C264	QTE1E56-475Z	E CAPACITOR	4.7uF 25V	
C265	QTE1E56-475Z	E CAPACITOR	4.7uF 25V	
C281	QFV91HJ-474Z	MF CAPACITOR	0.47uF 50V J	
C282	QFV91HJ-474Z	MF CAPACITOR	0.47uF 50V J	
C283	NDC31HJ-101X	C CAPACITOR	100pF 50V J	
C284	NDC31HJ-101X	C CAPACITOR	100pF 50V J	
C285	NCB31CK-104X	C CAPACITOR	0.1uF 16V K	
C286	NCB31CK-104X	C CAPACITOR	0.1uF 16V K	
C287	NDC31HJ-101X	C CAPACITOR	100pF 50V J	
C288	NDC31HJ-101X	C CAPACITOR	100pF 50V J	
C289	NDC31HJ-101X	C CAPACITOR	100pF 50V J	
C290	NDC31HJ-101X	C CAPACITOR	100pF 50V J	
C701	NDC31HJ-8R0X	C CAPACITOR	8pF 50V J	
C702	NDC31HJ-270X	C CAPACITOR	27pF 50V J	
C703	NDC31HJ-270X	C CAPACITOR	27pF 50V J	
C704	NDC31HJ-220X	C CAPACITOR	22pF 50V J	
C705	NCB31HK-103X	C CAPACITOR	0.01uF 50V K	
C706	NCB31HK-103X	C CAPACITOR	0.01uF 50V K	
C708	QERF0JM-476Z	E CAPACITOR	47uF 6.3V M	
C710	QERF1AM-227Z	E CAPACITOR	220uF 10V M	
C711	QERF1AM-227Z	E CAPACITOR	220uF 10V M	
C712	QERF1AM-227Z	E CAPACITOR	220uF 10V M	
C713	NCB31CK-473X	C CAPACITOR	0.047uF 16V K	
C714	NCB31CK-104X	C CAPACITOR	0.1uF 16V K	
C715	NCB31HK-103X	C CAPACITOR	0.01uF 50V K	
C716	NDC31HJ-101X	C CAPACITOR	100pF 50V J	
C717	NCB31HK-103X	C CAPACITOR	0.01uF 50V K	
C720	NCB31HK-103X	C CAPACITOR	0.01uF 50V K	
C721	NCB31HK-103X	C CAPACITOR	0.01uF 50V K	
C722	NCB31HK-103X	C CAPACITOR	0.01uF 50V K	
C723	NCB31HK-103X	C CAPACITOR	0.01uF 50V K	
C724	NCB31HK-103X	C CAPACITOR	0.01uF 50V K	
C725	NCB31CK-104X	C CAPACITOR	0.1uF 16V K	
C726	NCB31CK-104X	C CAPACITOR	0.1uF 16V K	
C727	NCB31CK-104X	C CAPACITOR	0.1uF 16V K	
C728	NCB31CK-104X	C CAPACITOR	0.1uF 16V K	
C730	NCB31HK-103X	C CAPACITOR	0.01uF 50V K	

△ Symbol No.	Part No.	Part Name	Description	Local	△ Symbol No.	Part No.	Part Name	Description	Local
C731	NCB31HK-103X	C CAPACITOR	0.01uF 50V K		R718	NRSA63J-222X	MG RESISTOR	2.2kΩ 1/16W J	
C732	NCB31HK-103X	C CAPACITOR	0.01uF 50V K		R719	NRSA63J-223X	MG RESISTOR	22kΩ 1/16W J	
C733	NCB31HK-103X	C CAPACITOR	0.01uF 50V K		R720	NRSA63J-103X	MG RESISTOR	10kΩ 1/16W J	
C735	NDC31HJ-101X	C CAPACITOR	100pF 50V J		R721	NRSA63J-332X	MG RESISTOR	3.3kΩ 1/16W J	
C736	NDC31HJ-101X	C CAPACITOR	100pF 50V J		R722	NRSA63J-103X	MG RESISTOR	10kΩ 1/16W J	
C781	NCB31CK-473X	C CAPACITOR	0.047uF 16V K		R723	NRSA63J-332X	MG RESISTOR	3.3kΩ 1/16W J	
C901	QEZ0676-338	E CAPACITOR	3300uF		R724	NRSA63J-103X	MG RESISTOR	10kΩ 1/16W J	
C902	QERF1HM-225Z	E CAPACITOR	2.2uF 50V M		R725	NRSA63J-332X	MG RESISTOR	3.3kΩ 1/16W J	
C903	QERF1CM-226Z	E CAPACITOR	22uF 16V M		R726	NRSA63J-102X	MG RESISTOR	1kΩ 1/16W J	
C904	QERF1CM-226Z	E CAPACITOR	22uF 16V M		R727	NRSA63J-102X	MG RESISTOR	1kΩ 1/16W J	
C905	NCB31HK-103X	C CAPACITOR	0.01uF 50V K		R728	NRSA63J-102X	MG RESISTOR	1kΩ 1/16W J	
C906	QERF1AM-227Z	E CAPACITOR	220uF 10V M		R731	NRSA63J-0R0X	MG RESISTOR	0Ω 1/16W J	
C907	NCB31CK-104X	C CAPACITOR	0.1uF 16V K		R732	NRSA63J-473X	MG RESISTOR	47kΩ 1/16W J	
C908	NCB31CK-104X	C CAPACITOR	0.1uF 16V K		R733	NRSA63J-102X	MG RESISTOR	1kΩ 1/16W J	
C909	QERF1AM-227Z	E CAPACITOR	220uF 10V M		R734	NRSA63J-102X	MG RESISTOR	1kΩ 1/16W J	
C911	QERF1CM-106Z	E CAPACITOR	10uF 16V M		R739	NRSA63J-222X	MG RESISTOR	2.2kΩ 1/16W J	
C912	NCB31CK-104X	C CAPACITOR	0.1uF 16V K		R740	NRSA63J-222X	MG RESISTOR	2.2kΩ 1/16W J	
C921	QERF1CM-226Z	E CAPACITOR	22uF 16V M		R741	NRSA63J-222X	MG RESISTOR	2.2kΩ 1/16W J	
C951	QERF1AM-107Z	E CAPACITOR	100uF 10V M		R743	NRSA63J-102X	MG RESISTOR	1kΩ 1/16W J	
C952	QERF1CM-107Z	E CAPACITOR	100uF 16V M		R744	NRSA63J-102X	MG RESISTOR	1kΩ 1/16W J	
C953	NCB31CK-104X	C CAPACITOR	0.1uF 16V K		R745	NRSA63J-103X	MG RESISTOR	10kΩ 1/16W J	
C971	QERF1HM-105Z	E CAPACITOR	1uF 50V M		R746	NRSA63J-271X	MG RESISTOR	270Ω 1/16W J	
C972	QERF1CM-226Z	E CAPACITOR	22uF 16V M		R747	NRSA63J-271X	MG RESISTOR	270Ω 1/16W J	
C973	NCB31EK-473X	C CAPACITOR	0.047uF 25V K		R748	NRSA63J-0R0X	MG RESISTOR	0Ω 1/16W J	
C974	NCB31CK-224X	C CAPACITOR	0.22uF 16V K		R749	NRSA63J-0R0X	MG RESISTOR	0Ω 1/16W J	
R1	NRSA63J-103X	MG RESISTOR	10kΩ 1/16W J		R751	NRSA63J-102X	MG RESISTOR	1kΩ 1/16W J	
R2	NRSA63J-222X	MG RESISTOR	2.2kΩ 1/16W J		R752	NRSA63J-102X	MG RESISTOR	1kΩ 1/16W J	
R3	NRSA63J-103X	MG RESISTOR	10kΩ 1/16W J		R753	NRSA63J-102X	MG RESISTOR	1kΩ 1/16W J	
R4	NRSA63J-102X	MG RESISTOR	1kΩ 1/16W J		R754	NRSA63J-473X	MG RESISTOR	47kΩ 1/16W J	
R5	NRS181J-100X	MG RESISTOR	10Ω 1/8W J		R755	NRSA63J-473X	MG RESISTOR	47kΩ 1/16W J	
R7	NRS181J-4R7X	MG RESISTOR	4.7Ω 1/8W J		R756	NRSA63J-222X	MG RESISTOR	2.2kΩ 1/16W J	
R8	NRSA63J-473X	MG RESISTOR	47kΩ 1/16W J		R759	NRSA63J-473X	MG RESISTOR	47kΩ 1/16W J	
R9	NRSA63J-270X	MG RESISTOR	27Ω 1/16W J		R760	NRSA63J-102X	MG RESISTOR	1kΩ 1/16W J	
R10	NRSA63J-103X	MG RESISTOR	10kΩ 1/16W J		R762	NRSA63J-102X	MG RESISTOR	1kΩ 1/16W J	
R11	NRSA63J-393X	MG RESISTOR	39kΩ 1/16W J		R763	NRSA63J-102X	MG RESISTOR	1kΩ 1/16W J	
R101	NRSA63J-822X	MG RESISTOR	8.2kΩ 1/16W J		R764	NRSA63J-473X	MG RESISTOR	47kΩ 1/16W J	
R102	NRSA63J-682X	MG RESISTOR	6.8kΩ 1/16W J		R765	NRSA63J-102X	MG RESISTOR	1kΩ 1/16W J	
R141	NRSA63J-104X	MG RESISTOR	100kΩ 1/16W J		R766	NRSA63J-102X	MG RESISTOR	1kΩ 1/16W J	
R142	NRSA63J-101X	MG RESISTOR	100Ω 1/16W J		R767	NRSA63J-473X	MG RESISTOR	47kΩ 1/16W J	
R151	NRSA63J-473X	MG RESISTOR	47kΩ 1/16W J		R768	NRSA63J-102X	MG RESISTOR	1kΩ 1/16W J	
R152	NRSA63J-472X	MG RESISTOR	4.7kΩ 1/16W J		R769	NRSA63J-473X	MG RESISTOR	47kΩ 1/16W J	
R153	NRSA63J-333X	MG RESISTOR	33kΩ 1/16W J		R770	NRSA63J-473X	MG RESISTOR	47kΩ 1/16W J	
R154	NRSA63J-473X	MG RESISTOR	47kΩ 1/16W J		R773	NRSA63J-473X	MG RESISTOR	47kΩ 1/16W J	
R155	NRSA63J-473X	MG RESISTOR	47kΩ 1/16W J		R775	NRSA63J-473X	MG RESISTOR	47kΩ 1/16W J	
R156	NRSA63J-333X	MG RESISTOR	33kΩ 1/16W J		R776	NRSA63J-102X	MG RESISTOR	1kΩ 1/16W J	
R181	NRSA63J-273X	MG RESISTOR	27kΩ 1/16W J		R777	NRSA63J-473X	MG RESISTOR	47kΩ 1/16W J	
R182	NRSA63J-273X	MG RESISTOR	27kΩ 1/16W J		R778	NRSA63J-102X	MG RESISTOR	1kΩ 1/16W J	
R191	NRSA63J-222X	MG RESISTOR	2.2kΩ 1/16W J		R779	NRSA63J-103X	MG RESISTOR	10kΩ 1/16W J	
R192	NRSA63J-273X	MG RESISTOR	27kΩ 1/16W J		R781	NRSA63J-104X	MG RESISTOR	100kΩ 1/16W J	
R193	NRSA63J-0R0X	MG RESISTOR	0Ω 1/16W J		R782	NRSA63J-223X	MG RESISTOR	22kΩ 1/16W J	
R195	NRSA63J-182X	MG RESISTOR	1.8kΩ 1/16W J		R783	NRSA63J-101X	MG RESISTOR	100Ω 1/16W J	
R201	NRSA63J-822X	MG RESISTOR	8.2kΩ 1/16W J		R784	NRSA63J-473X	MG RESISTOR	47kΩ 1/16W J	
R202	NRSA63J-682X	MG RESISTOR	6.8kΩ 1/16W J		R785	NRSA63J-101X	MG RESISTOR	100Ω 1/16W J	
R241	NRSA63J-104X	MG RESISTOR	100kΩ 1/16W J		R786	NRSA63J-473X	MG RESISTOR	47kΩ 1/16W J	
R242	NRSA63J-101X	MG RESISTOR	100Ω 1/16W J		R787	NRSA63J-223X	MG RESISTOR	22kΩ 1/16W J	
R251	NRSA63J-473X	MG RESISTOR	47kΩ 1/16W J		R788	NRSA63J-331X	MG RESISTOR	330Ω 1/16W J	
R252	NRSA63J-472X	MG RESISTOR	4.7kΩ 1/16W J		R789	NRSA63J-104X	MG RESISTOR	100kΩ 1/16W J	
R254	NRSA63J-473X	MG RESISTOR	47kΩ 1/16W J		R790	NRSA63J-103X	MG RESISTOR	10kΩ 1/16W J	
R255	NRSA63J-473X	MG RESISTOR	47kΩ 1/16W J		R901	QRE142J-102X	C RESISTOR	1kΩ 1/4W J	
R256	NRSA63J-333X	MG RESISTOR	33kΩ 1/16W J		R902	NRSA63J-912X	MG RESISTOR	9.1kΩ 1/16W J	
R281	NRSA63J-273X	MG RESISTOR	27kΩ 1/16W J		R903	NRSA63J-472X	MG RESISTOR	4.7kΩ 1/16W J	
R282	NRSA63J-273X	MG RESISTOR	27kΩ 1/16W J		R904	NRSA63J-562X	MG RESISTOR	5.6kΩ 1/16W J	
R701	NRSA63J-102X	MG RESISTOR	1kΩ 1/16W J		R905	NRSA63J-102X	MG RESISTOR	1kΩ 1/16W J	
R703	NRSA63J-821X	MG RESISTOR	820Ω 1/16W J		R906	NRSA63J-103X	MG RESISTOR	10kΩ 1/16W J	
R704	NRSA63J-473X	MG RESISTOR	47kΩ 1/16W J		R907	NRSA63J-473X	MG RESISTOR	47kΩ 1/16W J	
R705	NRSA63J-106X	MG RESISTOR	10MΩ 1/16W J		R908	NRSA63J-473X	MG RESISTOR	47kΩ 1/16W J	
R706	NRSA63J-101X	MG RESISTOR	100Ω 1/16W J		R909	NRSA63J-473X	MG RESISTOR	47kΩ 1/16W J	
R707	NRSA63J-473X	MG RESISTOR	47kΩ 1/16W J		R910	NRSA63J-153X	MG RESISTOR	15kΩ 1/16W J	
R708	NRSA63J-222X	MG RESISTOR	2.2kΩ 1/16W J		R911	NRSA63J-473X	MG RESISTOR	47kΩ 1/16W J	
R709	NRSA63J-102X	MG RESISTOR	1kΩ 1/16W J		R912	NRS181J-102X	MG RESISTOR	1kΩ 1/8W J	
R710	NRSA63J-102X	MG RESISTOR	1kΩ 1/16W J		R915	NRSA63J-473X	MG RESISTOR	47kΩ 1/16W J	
R712	NRSA63J-102X	MG RESISTOR	1kΩ 1/16W J		R916	NRSA63J-222X	MG RESISTOR	2.2kΩ 1/16W J	
R713	NRSA63J-473X	MG RESISTOR	47kΩ 1/16W J		R921	NRSA63J-473X	MG RESISTOR	47kΩ 1/16W J	
R714	NRSA63J-102X	MG RESISTOR	1kΩ 1/16W J		R922	NRSA63J-472X	MG RESISTOR	4.7kΩ 1/16W J	
R715	NRSA63J-473X	MG RESISTOR	47kΩ 1/16W J		R923	NRSA63J-104X	MG RESISTOR	100kΩ 1/16W J	
R716	NRSA63J-102X	MG RESISTOR	1kΩ 1/16W J		R971	NRSA63J-224X	MG RESISTOR	220kΩ 1/16W J	
R717	NRSA63J-473X	MG RESISTOR	47kΩ 1/16W J		R972	NRSA63J-224X	MG RESISTOR	220kΩ 1/16W J	
					R973	NRSA63J-473X	MG RESISTOR	47kΩ 1/16W J	

△ Symbol No.	Part No.	Part Name	Description	Local
R974	NRSA63J-184X	MG RESISTOR	180kΩ 1/16W J	
R975	NRSA63J-223X	MG RESISTOR	22kΩ 1/16W J	
R976	NRSA63J-123X	MG RESISTOR	12kΩ 1/16W J	
R977	NRSA63J-470X	MG RESISTOR	47Ω 1/16W J	
R978	NRSA63J-102X	MG RESISTOR	1kΩ 1/16W J	
R979	NRSA63J-124X	MG RESISTOR	120kΩ 1/16W J	
R980	NRSA63J-123X	MG RESISTOR	12kΩ 1/16W J	
RA701	NRZ0065-102X	NET RESISTOR	1kΩ 1/16W J	
RA702	NRZ0065-102X	NET RESISTOR	1kΩ 1/16W J	
L1	QQL244J-4R7Z	COIL	4.7uH J	
L701	QQL244J-470Z	COIL	47uH J	
L702	QQL244J-470Z	COIL	47uH J	
L703	QQL244J-470Z	COIL	47uH J	
L704	NQL114M-4R7X	COIL	4.7uH M	
L781	NQL093K-1R8X	COIL	1.8uH K	
L782	NQL093K-1R8X	COIL	1.8uH K	
L901	QQR0703-001	CHOKO COIL		
CN323	QGA2001F1-07	CONNECTOR	W-B (1-7)	
CN701	QGB1004K1-20	CONNECTOR	B-B (1-20)	
CN702	QGB1004K1-16	CONNECTOR	B-B (1-16)	
CN704	QGA2006F1-02	CONNECTOR	W-B (1-2)	
CN705	QGB2027M4-22S	CONNECTOR	B-B (1-22)	
CN901	QNZ0611-001	16P CONNECTOR		
CN902	QNZ0095-001	CONNECTOR		
J1	QNB0190-001	ANTENNA JACK		
PP1	QZW0010-001	STYLE PIN		
TU1	QAU0403-001	TUNER PACK		
X701	QAX0617-001Z	CRYSTAL	12.500MHz	
X702	QAX0401-001	CRYSTAL	32.768KHz	

## Func board (KW-XC400\_J)

Block No. [0][2]

△ Symbol No.	Part No.	Part Name	Description	Local
Q321	KTD1304-X	TRANSISTOR		
Q331	KTD1304-X	TRANSISTOR		
Q341	KTD1304-X	TRANSISTOR		
Q351	KTD1304-X	TRANSISTOR		
D321	MC2836-X	DIODE		
D331	MC2836-X	DIODE		
R321	NRSA63J-821X	MG RESISTOR	820Ω 1/16W J	
R322	NRSA63J-181X	MG RESISTOR	180Ω 1/16W J	
R325	NRSA63J-222X	MG RESISTOR	2.2kΩ 1/16W J	
R331	NRSA63J-821X	MG RESISTOR	820Ω 1/16W J	
R332	NRSA63J-181X	MG RESISTOR	180Ω 1/16W J	
R335	NRSA63J-222X	MG RESISTOR	2.2kΩ 1/16W J	
R341	NRSA63J-821X	MG RESISTOR	820Ω 1/16W J	
R342	NRSA63J-181X	MG RESISTOR	180Ω 1/16W J	
R345	NRSA63J-222X	MG RESISTOR	2.2kΩ 1/16W J	
R351	NRSA63J-821X	MG RESISTOR	820Ω 1/16W J	
R352	NRSA63J-181X	MG RESISTOR	180Ω 1/16W J	
R355	NRSA63J-222X	MG RESISTOR	2.2kΩ 1/16W J	
CN322	QGA2001F1-07	CONNECTOR	W-B (1-7)	
J321	QNN0746-001	PIN JACK		

## Switch board (KW-XC400\_J)

Block No. [0][3]

△ Symbol No.	Part No.	Part Name	Description	Local
IC801	PT6578LQ-L	IC		
IC802	RPM7338-V4	RM.RECEIVER		
D801	UDZW5.1B-X	SI DIODE		

△ Symbol No.	Part No.	Part Name	Description	Local
D802	UDZW9.1B-X	Z DIODE		
D803	1SS355W-X	DIODE C.M		
D804	1SS355W-X	DIODE C.M		
D805	1SS355W-X	DIODE C.M		
D806	1SS355W-X	DIODE C.M		
D807	1SS355W-X	DIODE C.M		
D808	1SS355W-X	DIODE C.M		
D809	1SS355W-X	DIODE C.M		
D811	NSPW310BS/BRST/	LED		
D812	NSPW310BS/BRST/	LED		
D813	NSPW310BS/BRST/	LED		
D814	TO1608BCHC/Z/X	LED		
D815	LNJ308G81/1-3/X	LED		
D816	LNJ308G81/1-3/X	LED		
D817	LNJ308G81/1-3/X	LED		
D818	LNJ308G81/1-3/X	LED		
D819	LNJ308G81/1-3/X	LED		
D820	LNJ308G81/1-3/X	LED		
D821	LNJ308G81/1-3/X	LED		
D822	LNJ308G81/1-3/X	LED		
D823	LNJ308G81/1-3/X	LED		
D824	LNJ308G81/1-3/X	LED		
D825	LNJ308G81/1-3/X	LED		
D826	LNJ308G81/1-3/X	LED		
D827	LNJ308G81/1-3/X	LED		
D828	LNJ308G81/1-3/X	LED		
D829	LNJ308G81/1-3/X	LED		
D830	LNJ308G81/1-3/X	LED		
D831	LNJ308G81/1-3/X	LED		
D832	LNJ308G81/1-3/X	LED		
D833	LNJ308G81/1-3/X	LED		
D834	LNJ308G81/1-3/X	LED		
D835	LNJ308G81/1-3/X	LED		
D836	LNJ308G81/1-3/X	LED		
D837	LNJ308G81/1-3/X	LED		
D838	LNJ308G81/1-3/X	LED		
D839	LNJ308G81/1-3/X	LED		
D840	MC2838-X	DIODE		
D841	UDZW5.1B-X	SI DIODE		
C801	NCB31CK-104X	C CAPACITOR	0.1uF 16V K	
C802	NCB31CK-104X	C CAPACITOR	0.1uF 16V K	
C803	NCB31CK-104X	C CAPACITOR	0.1uF 16V K	
C804	NCB31CK-104X	C CAPACITOR	0.1uF 16V K	
C805	NCS31HJ-681X	C CAPACITOR	680pF 50V J	
C806	NBE20JM-475X	TA E CAPACITOR	4.7uF 6.3V M	
C807	NBE21CM-475X	TA E CAPACITOR	4.7uF 16V M	
C808	NBE20JM-475X	TA E CAPACITOR	4.7uF 6.3V M	
C809	NBE20JM-475X	TA E CAPACITOR	4.7uF 6.3V M	
C810	NCB31HK-472X	C CAPACITOR	4700pF 50V K	
C811	NCB31HK-472X	C CAPACITOR	4700pF 50V K	
C812	NCB31CK-473X	C CAPACITOR	0.047uF 16V K	
C813	NCB31HK-103X	C CAPACITOR	0.01uF 50V K	
C814	NCB31HK-103X	C CAPACITOR	0.01uF 50V K	
R801	NRS181J-182X	MG RESISTOR	1.8kΩ 1/8W J	
R802	NRSA63J-221X	MG RESISTOR	220Ω 1/16W J	
R803	NRSA63J-821X	MG RESISTOR	820Ω 1/16W J	
R804	NRSA63J-103X	MG RESISTOR	10kΩ 1/16W J	
R805	NRSA63J-103X	MG RESISTOR	10kΩ 1/16W J	
R806	NRSA63J-103X	MG RESISTOR	10kΩ 1/16W J	
R807	NRSA63J-103X	MG RESISTOR	10kΩ 1/16W J	
R808	NRSA63J-332X	MG RESISTOR	3.3kΩ 1/16W J	
R809	NRSA63J-332X	MG RESISTOR	3.3kΩ 1/16W J	
R810	NRSA63J-332X	MG RESISTOR	3.3kΩ 1/16W J	
R811	NRSA63J-683X	MG RESISTOR	68kΩ 1/16W J	
R812	NRSA63J-394X	MG RESISTOR	390kΩ 1/16W J	
R814	NRS181J-391X	MG RESISTOR	390Ω 1/8W J	
R816	NRS181J-391X	MG RESISTOR	390Ω 1/8W J	
R818	NRS181J-391X	MG RESISTOR	390Ω 1/8W J	
R820	NRSA02J-821X	MG RESISTOR	820Ω 1/10W J	
R822	NRSA02J-821X	MG RESISTOR	820Ω 1/10W J	
R824	NRSA02J-471X	MG RESISTOR	470Ω 1/10W J	
R826	NRSA02J-471X	MG RESISTOR	470Ω 1/10W J	
R828	NRSA02J-331X	MG RESISTOR	330Ω 1/10W J	
R830	NRSA02J-331X	MG RESISTOR	330Ω 1/10W J	
R832	NRSA02J-331X	MG RESISTOR	330Ω 1/10W J	
R834	NRSA02J-331X	MG RESISTOR	330Ω 1/10W J	

△ Symbol No.	Part No.	Part Name	Description	Local	△ Symbol No.	Part No.	Part Name	Description	Local
R836	NRSA02J-331X	MG RESISTOR	330Ω 1/10W J		IC571	PCM1753-X	IC		
R838	NRSA02J-331X	MG RESISTOR	330Ω 1/10W J		IC572	NJM4580V-X	IC		
R840	NRSA02J-331X	MG RESISTOR	330Ω 1/10W J		IC573	SN74AHC04PW-X	IC		
R842	NRSA02J-471X	MG RESISTOR	470Ω 1/10W J		IC601	TA2157FN-X	RF AMP IC		
R844	NRSA02J-471X	MG RESISTOR	470Ω 1/10W J		IC621	TC94A14FA	IC		
R846	NRSA02J-331X	MG RESISTOR	330Ω 1/10W J		IC651	NJU7772F15-X	IC		
R848	NRSA02J-331X	MG RESISTOR	330Ω 1/10W J		IC652	TC94A34FG-002	IC		
R850	NRSA02J-471X	MG RESISTOR	470Ω 1/10W J		IC681	BA5830FP-X	IC		
R852	NRSA02J-331X	MG RESISTOR	330Ω 1/10W J						
R853	NRSA63J-103X	MG RESISTOR	10kΩ 1/16W J		Q501	RT1P141C-X	DIGI TRANSISTOR		
R854	NRSA63J-471X	MG RESISTOR	470Ω 1/16W J		Q502	RT1N141C-X	DIGI TRANSISTOR		
R855	NRSA63J-103X	MG RESISTOR	10kΩ 1/16W J		Q571	RT1P141C-X	DIGI TRANSISTOR		
R856	NRSA63J-473X	MG RESISTOR	47kΩ 1/16W J		Q572	RT1N141C-X	DIGI TRANSISTOR		
R857	NRSA63J-473X	MG RESISTOR	47kΩ 1/16W J		Q573	2SA1365/F-X	TRANSISTOR		
R859	NRSA63J-0R0X	MG RESISTOR	0Ω 1/16W J		Q574	RT1N141C-X	DIGI TRANSISTOR		
R860	NRSA63J-0R0X	MG RESISTOR	0Ω 1/16W J		Q601	2SA1947/E-X	CHIP.TR.C.M		
R863	NRSA63J-332X	MG RESISTOR	3.3kΩ 1/16W J		Q651	2SA1365/F-X	TRANSISTOR		
R871	NRSA63J-621X	MG RESISTOR	620Ω 1/16W J		Q652	RT1N141C-X	DIGI TRANSISTOR		
R872	NRSA63J-621X	MG RESISTOR	620Ω 1/16W J		Q681	2SB1184/QR-X	TRANSISTOR		
R873	NRSA63J-821X	MG RESISTOR	820Ω 1/16W J						
R874	NRSA63J-122X	MG RESISTOR	1.2kΩ 1/16W J		D506	1SS355W-X	DIODE C.M		
R875	NRSA63J-621X	MG RESISTOR	620Ω 1/16W J		D682	1SR154-400-X	DIODE		
R876	NRSA63J-621X	MG RESISTOR	620Ω 1/16W J						
R877	NRSA63J-821X	MG RESISTOR	820Ω 1/16W J		C501	NCB31HK-103X	C CAPACITOR	0.01uF 50V K	
R878	NRSA63J-122X	MG RESISTOR	1.2kΩ 1/16W J		C502	NCB31HK-103X	C CAPACITOR	0.01uF 50V K	
R879	NRSA63J-182X	MG RESISTOR	1.8kΩ 1/16W J		C503	NEAG0JM-107X	E CAPACITOR	100uF 6.3V M	
R880	NRSA63J-302X	MG RESISTOR	3kΩ 1/16W J		C504	NDC31HJ-220X	C CAPACITOR	22pF 50V J	
R881	NRSA63J-562X	MG RESISTOR	5.6kΩ 1/16W J		C505	NDC31HJ-220X	C CAPACITOR	22pF 50V J	
R882	NRSA63J-621X	MG RESISTOR	620Ω 1/16W J		C506	NCB31HK-103X	C CAPACITOR	0.01uF 50V K	
R883	NRSA63J-621X	MG RESISTOR	620Ω 1/16W J		C507	NCB31HK-103X	C CAPACITOR	0.01uF 50V K	
R884	NRSA63J-821X	MG RESISTOR	820Ω 1/16W J		C508	NCB31HK-103X	C CAPACITOR	0.01uF 50V K	
R885	NRSA63J-122X	MG RESISTOR	1.2kΩ 1/16W J		C509	NCB31HK-103X	C CAPACITOR	0.01uF 50V K	
R886	NRSA63J-182X	MG RESISTOR	1.8kΩ 1/16W J		C510	NCB31HK-103X	C CAPACITOR	0.01uF 50V K	
R887	NRSA63J-302X	MG RESISTOR	3kΩ 1/16W J		C511	NCB31CK-104X	C CAPACITOR	0.1uF 16V K	
					C512	NEAG0JM-107X	E CAPACITOR	100uF 6.3V M	
CN801	QGB1004J2-20X	CONNECTOR	B-B (1-20)		C513	NCB31HK-103X	C CAPACITOR	0.01uF 50V K	
CN802	QGB1004J2-16X	CONNECTOR	B-B (1-16)		C514	NCS31HJ-102X	C CAPACITOR	1000pF 50V J	
CN803	QGB1004J2-16X	CONNECTOR	B-B (1-16)		C551	NCB31HK-103X	C CAPACITOR	0.01uF 50V K	
EN851	QSW0976-001	ROTARY ENCODER			C561	NCB31HK-123X	C CAPACITOR	0.012uF 50V K	
PJ801	QNS0180-002	3.5 JACK			C571	NDC31HJ-270X	C CAPACITOR	27pF 50V J	
S851	NSW0246-001X	TACK SW			C572	NDC31HJ-270X	C CAPACITOR	27pF 50V J	
S852	NSW0246-001X	TACK SW			C573	NCB31CK-104X	C CAPACITOR	0.1uF 16V K	
S853	NSW0246-001X	TACK SW			C574	NEAG0JM-107X	E CAPACITOR	100uF 6.3V M	
S854	NSW0246-001X	TACK SW			C575	NEAG0JM-107X	E CAPACITOR	100uF 6.3V M	
S855	NSW0246-001X	TACK SW			C577	NCB31CK-104X	C CAPACITOR	0.1uF 16V K	
S856	NSW0246-001X	TACK SW			C578	NEAG0JM-107X	E CAPACITOR	100uF 6.3V M	
S857	NSW0246-001X	TACK SW			C580	NCB31HK-123X	C CAPACITOR	0.012uF 50V K	
S858	NSW0246-001X	TACK SW			C581	NDC31HJ-101X	C CAPACITOR	100pF 50V J	
S859	NSW0246-001X	TACK SW			C582	NDC31HJ-101X	C CAPACITOR	100pF 50V J	
S860	NSW0246-001X	TACK SW			C583	NCS31HJ-821X	C CAPACITOR	820pF 50V J	
S861	NSW0246-001X	TACK SW			C584	NCS31HJ-821X	C CAPACITOR	820pF 50V J	
S862	NSW0246-001X	TACK SW			C585	NEAG1VM-475X	E CAPACITOR	4.7uF 35V M	
S863	NSW0246-001X	TACK SW			C586	NEAG1VM-475X	E CAPACITOR	4.7uF 35V M	
S864	NSW0246-001X	TACK SW			C587	NDC31HJ-151X	C CAPACITOR	150pF 50V J	
S865	NSW0246-001X	TACK SW			C588	NDC31HJ-151X	C CAPACITOR	150pF 50V J	
S866	NSW0246-001X	TACK SW			C589	NEAG1VM-475X	E CAPACITOR	4.7uF 35V M	
S867	NSW0246-001X	TACK SW			C590	NEAG1VM-475X	E CAPACITOR	4.7uF 35V M	
S868	NSW0246-001X	TACK SW			C591	NEAG0JM-476X	E CAPACITOR	47uF 6.3V M	
S869	NSW0246-001X	TACK SW			C592	NEAG0JM-476X	E CAPACITOR	47uF 6.3V M	
S870	NSW0246-001X	TACK SW			C593	NEAG1CM-476X	E CAPACITOR	47uF 16V M	
S871	NSW0246-001X	TACK SW			C594	NCS31HJ-102X	C CAPACITOR	1000pF 50V J	
TH855	NAD0028-103X	N THERMISTOR	10kΩ		C595	NCB31CK-473X	C CAPACITOR	0.047uF 16V K	
					C596	NDC31HJ-101X	C CAPACITOR	100pF 50V J	
					C597	NCS31HJ-102X	C CAPACITOR	1000pF 50V J	
					C598	NCS31HJ-102X	C CAPACITOR	1000pF 50V J	
					C601	NEAG0JM-476X	E CAPACITOR	47uF 6.3V M	
					C602	NCB31HK-103X	C CAPACITOR	0.01uF 50V K	
					C603	NEAG0JM-107X	E CAPACITOR	100uF 6.3V M	
					C604	NCB31HK-103X	C CAPACITOR	0.01uF 50V K	
					C605	NCB31HK-682X	C CAPACITOR	6800pF 50V K	
					C606	NEAG0JM-476X	E CAPACITOR	47uF 6.3V M	
					C607	NCB31HK-103X	C CAPACITOR	0.01uF 50V K	
					C608	NCB31CK-104X	C CAPACITOR	0.1uF 16V K	
					C609	NCB31CK-104X	C CAPACITOR	0.1uF 16V K	
					C610	NDC31HJ-5R0X	C CAPACITOR	5pF 50V J	
					C611	NDC31HJ-680X	C CAPACITOR	68pF 50V J	
					C612	NCB31HK-103X	C CAPACITOR	0.01uF 50V K	
					C613	NCB31HK-103X	C CAPACITOR	0.01uF 50V K	

## CD mechanism control board (KW-XC400\_J)

Block No. [0][4]

△ Symbol No.	Part No.	Part Name	Description	Local
IC501	TMP91CW12AF5VD9	IC		
IC502	BR24L01AFV-W-X	IC		
IC503	SN74AHCT126PW-X	IC(DIGITAL)		
IC504	NJU7241F33-X	IC		

△ Symbol No.	Part No.	Part Name	Description	Local	△ Symbol No.	Part No.	Part Name	Description	Local
C614	NCB31HK-103X	C CAPACITOR	0.01uF 50V K		R530	NRSA63J-473X	MG RESISTOR	47kΩ 1/16W J	
C616	NBE20JM-106X	TA E CAPACITOR	10uF 6.3V M		R531	NRSA63J-473X	MG RESISTOR	47kΩ 1/16W J	
C621	NCB31HK-103X	C CAPACITOR	0.01uF 50V K		R532	NRSA63J-102X	MG RESISTOR	1kΩ 1/16W J	
C622	NEAG0JM-476X	E CAPACITOR	47uF 6.3V M		R533	NRSA63J-101X	MG RESISTOR	100Ω 1/16W J	
C623	NDC31HJ-470X	C CAPACITOR	47pF 50V J		R534	NRSA63J-101X	MG RESISTOR	100Ω 1/16W J	
C624	NCB31HK-153X	C CAPACITOR	0.015uF 50V K		R535	NRSA63J-101X	MG RESISTOR	100Ω 1/16W J	
C625	NCB31HK-103X	C CAPACITOR	0.01uF 50V K		R536	NRSA63J-101X	MG RESISTOR	100Ω 1/16W J	
C626	NCB31HK-272X	C CAPACITOR	2700pF 50V K		R537	NRSA63J-101X	MG RESISTOR	100Ω 1/16W J	
C627	NCB31HK-103X	C CAPACITOR	0.01uF 50V K		R539	NRSA63J-473X	MG RESISTOR	47kΩ 1/16W J	
C628	NEAG0JM-476X	E CAPACITOR	47uF 6.3V M		R540	NRSA63J-473X	MG RESISTOR	47kΩ 1/16W J	
C629	NCB31EK-333X	C CAPACITOR	0.033uF 25V K		R541	NRSA63J-101X	MG RESISTOR	100Ω 1/16W J	
C630	NCB31EK-333X	C CAPACITOR	0.033uF 25V K		R542	NRSA63J-103X	MG RESISTOR	10kΩ 1/16W J	
C631	NDC31HJ-471X	C CAPACITOR	470pF 50V J		R543	NRSA63J-101X	MG RESISTOR	100Ω 1/16W J	
C632	NDC31HJ-471X	C CAPACITOR	470pF 50V J		R544	NRSA63J-101X	MG RESISTOR	100Ω 1/16W J	
C633	NCB31CK-473X	C CAPACITOR	0.047uF 16V K		R545	NRSA63J-103X	MG RESISTOR	10kΩ 1/16W J	
C634	NCB31CK-473X	C CAPACITOR	0.047uF 16V K		R546	NRSA63J-271X	MG RESISTOR	270Ω 1/16W J	
C635	NCB31CK-473X	C CAPACITOR	0.047uF 16V K		R547	NRSA63J-271X	MG RESISTOR	270Ω 1/16W J	
C636	NCB31CK-473X	C CAPACITOR	0.047uF 16V K		R548	NRSA63J-822X	MG RESISTOR	8.2kΩ 1/16W J	
C637	NCB31CK-473X	C CAPACITOR	0.047uF 16V K		R549	NRSA63J-472X	MG RESISTOR	4.7kΩ 1/16W J	
C638	NCB31HK-103X	C CAPACITOR	0.01uF 50V K		R550	NRSA63J-472X	MG RESISTOR	4.7kΩ 1/16W J	
C639	NEAG0JM-476X	E CAPACITOR	47uF 6.3V M		R551	NRSA63J-104X	MG RESISTOR	100kΩ 1/16W J	
C640	NCB31HK-103X	C CAPACITOR	0.01uF 50V K		R552	NRSA63J-104X	MG RESISTOR	100kΩ 1/16W J	
C641	NEAG0JM-476X	E CAPACITOR	47uF 6.3V M		R553	NRSA63J-183X	MG RESISTOR	18kΩ 1/16W J	
C642	NDC31HJ-101X	C CAPACITOR	100pF 50V J		R554	NRSA63J-333X	MG RESISTOR	33kΩ 1/16W J	
C643	NCB31HK-103X	C CAPACITOR	0.01uF 50V K		R555	NRSA63J-101X	MG RESISTOR	100Ω 1/16W J	
C644	NCB31AK-334X	C CAPACITOR	0.33uF 10V K		R556	NRSA63J-0R0X	MG RESISTOR	0Ω 1/16W J	
C645	NEAG0JM-476X	E CAPACITOR	47uF 6.3V M		R557	NRSA63J-104X	MG RESISTOR	100kΩ 1/16W J	
C646	NCB31HK-103X	C CAPACITOR	0.01uF 50V K		R558	NRSA63J-104X	MG RESISTOR	100kΩ 1/16W J	
C651	NEAG0JM-476X	E CAPACITOR	47uF 6.3V M		R559	NRSA63J-0R0X	MG RESISTOR	0Ω 1/16W J	
C652	NCB31HK-103X	C CAPACITOR	0.01uF 50V K		R560	NRSA63J-101X	MG RESISTOR	100Ω 1/16W J	
C653	NEAG0JM-476X	E CAPACITOR	47uF 6.3V M		R561	NRSA63J-104X	MG RESISTOR	100kΩ 1/16W J	
C654	NCB31CK-104X	C CAPACITOR	0.1uF 16V K		R562	NRSA63J-392X	MG RESISTOR	3.9kΩ 1/16W J	
C655	NCB31HK-103X	C CAPACITOR	0.01uF 50V K		R563	NRSA63J-682X	MG RESISTOR	6.8kΩ 1/16W J	
C656	NCB31CK-104X	C CAPACITOR	0.1uF 16V K		R568	NRSA63J-102X	MG RESISTOR	1kΩ 1/16W J	
C659	NCB31CK-104X	C CAPACITOR	0.1uF 16V K		R569	NRSA63J-102X	MG RESISTOR	1kΩ 1/16W J	
C660	NDC31HJ-101X	C CAPACITOR	100pF 50V J		R570	NRSA63J-102X	MG RESISTOR	1kΩ 1/16W J	
C661	NCB31HK-103X	C CAPACITOR	0.01uF 50V K		R572	NRSA63J-225X	MG RESISTOR	2.2MΩ 1/16W J	
C662	NDC31HJ-101X	C CAPACITOR	100pF 50V J		R573	NRSA63J-102X	MG RESISTOR	1kΩ 1/16W J	
C663	NBE20JM-106X	TA E CAPACITOR	10uF 6.3V M		R574	NRSA63J-470X	MG RESISTOR	47Ω 1/16W J	
C664	NCB31HK-222X	C CAPACITOR	2200pF 50V K		R575	NRSA63J-102X	MG RESISTOR	1kΩ 1/16W J	
C665	NCB31CK-104X	C CAPACITOR	0.1uF 16V K		R576	NRSA63J-102X	MG RESISTOR	1kΩ 1/16W J	
C666	NDC31HJ-101X	C CAPACITOR	100pF 50V J		R577	NRSA63J-101X	MG RESISTOR	100Ω 1/16W J	
C667	NCB31HK-103X	C CAPACITOR	0.01uF 50V K		R578	NRSA63J-473X	MG RESISTOR	47kΩ 1/16W J	
C668	NEAG0JM-476X	E CAPACITOR	47uF 6.3V M		R579	NRSA63J-222X	MG RESISTOR	2.2kΩ 1/16W J	
C669	NCB31HK-103X	C CAPACITOR	0.01uF 50V K		R581	NRSA63J-243X	MG RESISTOR	24kΩ 1/16W J	
C682	NEAG1VM-475X	E CAPACITOR	4.7uF 35V M		R582	NRSA63J-243X	MG RESISTOR	24kΩ 1/16W J	
C683	NCB31CK-104X	C CAPACITOR	0.1uF 16V K		R583	NRSA63J-822X	MG RESISTOR	8.2kΩ 1/16W J	
C684	NEAG1CM-476X	E CAPACITOR	47uF 16V M		R584	NRSA63J-822X	MG RESISTOR	8.2kΩ 1/16W J	
C689	NEAG1CM-476X	E CAPACITOR	47uF 16V M		R585	NRSA63J-273X	MG RESISTOR	27kΩ 1/16W J	
C690	NBE20JM-106X	TA E CAPACITOR	10uF 6.3V M		R586	NRSA63J-273X	MG RESISTOR	27kΩ 1/16W J	
C693	NEAG1CM-476X	E CAPACITOR	47uF 16V M		R587	NRSA63J-473X	MG RESISTOR	47kΩ 1/16W J	
					R588	NRSA63J-473X	MG RESISTOR	47kΩ 1/16W J	
R501	NRSA63J-102X	MG RESISTOR	1kΩ 1/16W J		R589	NRSA63J-103X	MG RESISTOR	10kΩ 1/16W J	
R502	NRSA63J-102X	MG RESISTOR	1kΩ 1/16W J		R590	NRSA63J-103X	MG RESISTOR	10kΩ 1/16W J	
R503	NRSA63J-102X	MG RESISTOR	1kΩ 1/16W J		R591	NRSA63J-103X	MG RESISTOR	10kΩ 1/16W J	
R504	NRSA63J-101X	MG RESISTOR	100Ω 1/16W J		R592	NRSA63J-103X	MG RESISTOR	10kΩ 1/16W J	
R505	NRSA63J-101X	MG RESISTOR	100Ω 1/16W J		R593	NRSA63J-4R7X	MG RESISTOR	4.7Ω 1/16W J	
R506	NRSA63J-473X	MG RESISTOR	47kΩ 1/16W J		R594	NRSA63J-470X	MG RESISTOR	47Ω 1/16W J	
R507	NRSA63J-473X	MG RESISTOR	47kΩ 1/16W J		R595	NRSA63J-470X	MG RESISTOR	47Ω 1/16W J	
R508	NRSA63J-473X	MG RESISTOR	47kΩ 1/16W J		R601	NRSA63J-823X	MG RESISTOR	82kΩ 1/16W J	
R509	NRSA63J-473X	MG RESISTOR	47kΩ 1/16W J		R602	NRSA63J-823X	MG RESISTOR	82kΩ 1/16W J	
R510	NRSA63J-101X	MG RESISTOR	100Ω 1/16W J		R603	NRSA63J-334X	MG RESISTOR	330kΩ 1/16W J	
R511	NRSA63J-102X	MG RESISTOR	1kΩ 1/16W J		R604	NRSA63J-334X	MG RESISTOR	330kΩ 1/16W J	
R512	NRSA63J-473X	MG RESISTOR	47kΩ 1/16W J		R605	NRSA63J-220X	MG RESISTOR	22Ω 1/16W J	
R513	NRSA63J-102X	MG RESISTOR	1kΩ 1/16W J		R606	NRSA63J-220X	MG RESISTOR	22Ω 1/16W J	
R514	NRSA63J-473X	MG RESISTOR	47kΩ 1/16W J		R607	NRSA63J-823X	MG RESISTOR	82kΩ 1/16W J	
R515	NRSA63J-473X	MG RESISTOR	47kΩ 1/16W J		R608	NRSA63J-821X	MG RESISTOR	820Ω 1/16W J	
R516	NRSA63J-102X	MG RESISTOR	1kΩ 1/16W J		R609	NRSA63J-563X	MG RESISTOR	56kΩ 1/16W J	
R517	NRSA63J-101X	MG RESISTOR	100Ω 1/16W J		R610	NRSA63J-101X	MG RESISTOR	100Ω 1/16W J	
R518	NRSA63J-101X	MG RESISTOR	100Ω 1/16W J		R611	NRSA63J-103X	MG RESISTOR	10kΩ 1/16W J	
R519	NRSA63J-101X	MG RESISTOR	100Ω 1/16W J		R612	NRSA63J-202X	MG RESISTOR	2kΩ 1/16W J	
R520	NRSA63J-101X	MG RESISTOR	100Ω 1/16W J		R613	NRSA63J-102X	MG RESISTOR	1kΩ 1/16W J	
R521	NRSA63J-101X	MG RESISTOR	100Ω 1/16W J		R614	NRSA63J-153X	MG RESISTOR	15kΩ 1/16W J	
R522	NRSA63J-101X	MG RESISTOR	100Ω 1/16W J		R615	NRSA63J-151X	MG RESISTOR	150Ω 1/16W J	
R523	NRSA63J-101X	MG RESISTOR	100Ω 1/16W J		R616	NRSA63J-103X	MG RESISTOR	10kΩ 1/16W J	
R525	NRSA63J-104X	MG RESISTOR	100kΩ 1/16W J		R621	NRSA63J-470X	MG RESISTOR	47Ω 1/16W J	
R526	NRSA63J-473X	MG RESISTOR	47kΩ 1/16W J		R622	NRSA63J-470X	MG RESISTOR	47Ω 1/16W J	
R528	NRSA63J-473X	MG RESISTOR	47kΩ 1/16W J		R623	NRSA63J-470X	MG RESISTOR	47Ω 1/16W J	

△ Symbol No.	Part No.	Part Name	Description	Local	△ Symbol No.	Part No.	Part Name	Description	Local
R624	NRSA63J-562X	MG RESISTOR	5.6kΩ 1/16W J						
R625	NRSA63J-473X	MG RESISTOR	47kΩ 1/16W J		C401	NDC31HJ-101X	C CAPACITOR	100pF 50V J	
R626	NRSA63J-474X	MG RESISTOR	470kΩ 1/16W J		C402	NDC31HJ-101X	C CAPACITOR	100pF 50V J	
R627	NRSA63J-153X	MG RESISTOR	15kΩ 1/16W J		C403	NDC31HJ-101X	C CAPACITOR	100pF 50V J	
R628	NRSA63J-155X	MG RESISTOR	1.5MΩ 1/16W J		C404	NDC31HJ-101X	C CAPACITOR	100pF 50V J	
R629	NRSA63J-103X	MG RESISTOR	10kΩ 1/16W J		C405	NDC31HJ-101X	C CAPACITOR	100pF 50V J	
R630	NRSA63J-101X	MG RESISTOR	100Ω 1/16W J		C406	NDC31HJ-101X	C CAPACITOR	100pF 50V J	
R631	NRSA63J-101X	MG RESISTOR	100Ω 1/16W J		C407	NDC31HJ-101X	C CAPACITOR	100pF 50V J	
R632	NRSA63J-0R0X	MG RESISTOR	0Ω 1/16W J		C408	NDC31HJ-101X	C CAPACITOR	100pF 50V J	
R633	NRSA63J-0R0X	MG RESISTOR	0Ω 1/16W J		C409	QEKJ1CM-226Z	E CAPACITOR	22uF 16V M	
R634	NRSA63J-0R0X	MG RESISTOR	0Ω 1/16W J		C410	NCB31HK-153X	C CAPACITOR	0.015uF 50V K	
R635	NRSA63J-101X	MG RESISTOR	100Ω 1/16W J		C411	NCB31HK-153X	C CAPACITOR	0.015uF 50V K	
R636	NRSA63J-101X	MG RESISTOR	100Ω 1/16W J		C412	NCB31CK-104X	C CAPACITOR	0.1uF 16V K	
R637	NRSA63J-105X	MG RESISTOR	1MΩ 1/16W J		C413	NCB31CK-104X	C CAPACITOR	0.1uF 16V K	
R638	NRSA63J-472X	MG RESISTOR	4.7kΩ 1/16W J		C414	QEKJ1CM-226Z	E CAPACITOR	22uF 16V M	
R639	NRSA63J-472X	MG RESISTOR	4.7kΩ 1/16W J		C416	NCB31CK-104X	C CAPACITOR	0.1uF 16V K	
R640	NRSA63J-472X	MG RESISTOR	4.7kΩ 1/16W J		C417	NCB31CK-104X	C CAPACITOR	0.1uF 16V K	
R641	NRSA63J-472X	MG RESISTOR	4.7kΩ 1/16W J		C418	NDC31HJ-221X	C CAPACITOR	220pF 50V J	
R642	NRSA63J-103X	MG RESISTOR	10kΩ 1/16W J		C419	QEKJ1HM-474Z	E CAPACITOR	0.47uF 50V M	
R651	NRSA63J-104X	MG RESISTOR	100kΩ 1/16W J		C421	NCB31HK-103X	C CAPACITOR	0.01uF 50V K	
R654	NRSA63J-390X	MG RESISTOR	39Ω 1/16W J		C422	NCB31CK-104X	C CAPACITOR	0.1uF 16V K	
R655	NRSA63J-103X	MG RESISTOR	10kΩ 1/16W J		C423	QEKJ1CM-106Z	E CAPACITOR	10uF 16V M	
R656	NRSA63J-473X	MG RESISTOR	47kΩ 1/16W J		C424	NCB31CK-104X	C CAPACITOR	0.1uF 16V K	
R657	NRSA63J-222X	MG RESISTOR	2.2kΩ 1/16W J		C425	NCB31HK-103X	C CAPACITOR	0.01uF 50V K	
R668	NRSA63J-470X	MG RESISTOR	47Ω 1/16W J		C426	QEKJ1CM-106Z	E CAPACITOR	10uF 16V M	
R675	NRSA63J-221X	MG RESISTOR	220Ω 1/16W J		C427	QEKJ1CM-106Z	E CAPACITOR	10uF 16V M	
R681	NRSA63J-682X	MG RESISTOR	6.8kΩ 1/16W J		C428	NDC31HJ-101X	C CAPACITOR	100pF 50V J	
R682	NRSA63J-222X	MG RESISTOR	2.2kΩ 1/16W J		C431	QEKJOJM-476Z	E CAPACITOR	47uF 6.3V M	
R683	NRSA63J-682X	MG RESISTOR	6.8kΩ 1/16W J		C432	NCB31HK-103X	C CAPACITOR	0.01uF 50V K	
R684	NRSA63J-822X	MG RESISTOR	8.2kΩ 1/16W J		C433	QEKJOJM-476Z	E CAPACITOR	47uF 6.3V M	
R685	NRSA63J-682X	MG RESISTOR	6.8kΩ 1/16W J		C434	NCB31HK-103X	C CAPACITOR	0.01uF 50V K	
R686	NRSA63J-123X	MG RESISTOR	12kΩ 1/16W J		C435	NDC31HJ-220X	C CAPACITOR	22pF 50V J	
R687	NRSA63J-682X	MG RESISTOR	6.8kΩ 1/16W J		C436	NDC31HJ-220X	C CAPACITOR	22pF 50V J	
R688	NRSA63J-182X	MG RESISTOR	1.8kΩ 1/16W J		C437	NCB31HK-103X	C CAPACITOR	0.01uF 50V K	
R689	NRSA63J-123X	MG RESISTOR	12kΩ 1/16W J		C438	NCB31HK-103X	C CAPACITOR	0.01uF 50V K	
R690	NRSA63J-333X	MG RESISTOR	33kΩ 1/16W J		C439	NCB31HK-103X	C CAPACITOR	0.01uF 50V K	
R691	NRSA63J-153X	MG RESISTOR	15kΩ 1/16W J		C461	NCB31HK-103X	C CAPACITOR	0.01uF 50V K	
L501	NQL 114K-470X	COIL	47uH K		R401	NRS181J-681X	MG RESISTOR	680Ω 1/8W J	
L502	NQL 114K-470X	COIL	47uH K		R402	NRSA63J-104X	MG RESISTOR	100kΩ 1/16W J	
L572	NQL 114K-470X	COIL	47uH K		R403	NRSA63J-104X	MG RESISTOR	100kΩ 1/16W J	
L621	NQL 114K-470X	COIL	47uH K		R404	NRSA63J-104X	MG RESISTOR	100kΩ 1/16W J	
L622	NQL 114K-470X	COIL	47uH K		R405	NRSA63J-104X	MG RESISTOR	100kΩ 1/16W J	
L623	NQL 114K-470X	COIL	47uH K		R406	NRSA63J-181X	MG RESISTOR	180Ω 1/16W J	
L651	NQL 114K-470X	COIL	47uH K		R407	NRSA63J-181X	MG RESISTOR	180Ω 1/16W J	
L652	NQL 114K-470X	COIL	47uH K		R412	NRSA63J-101X	MG RESISTOR	100Ω 1/16W J	
L653	NQL 114K-470X	COIL	47uH K		R413	NRSA63J-183X	MG RESISTOR	18kΩ 1/16W J	
CN501	QGB2027L1-22X	CONNECTOR	B-B (1-22)		R414	NRSA63J-392X	MG RESISTOR	3.9kΩ 1/16W J	
CN601	QGF0501F8-22X	CONNECTOR	FFC/FPC (1-22)		R415	NRSA63J-223X	MG RESISTOR	22kΩ 1/16W J	
TH501	NAD0028-103X	N THERMISTOR	10kΩ		R416	NRSA63J-155X	MG RESISTOR	1.5MΩ 1/16W J	
X501	NAX0385-001X	CRYSTAL	24.576MHz		R417	NRSA63J-103X	MG RESISTOR	10kΩ 1/16W J	
X571	NAX0375-001X	CRYSTAL	16.9344MHz		R418	NRSA63J-153X	MG RESISTOR	15kΩ 1/16W J	
					R422	NRSA63J-332X	MG RESISTOR	3.3kΩ 1/16W J	
					R423	NRSA63J-473X	MG RESISTOR	47kΩ 1/16W J	
					R424	NRSA63J-222X	MG RESISTOR	2.2kΩ 1/16W J	
					R425	NRSA63J-680X	MG RESISTOR	68Ω 1/16W J	
					R426	NRSA63J-680X	MG RESISTOR	68Ω 1/16W J	
					R432	NRSA63J-473X	MG RESISTOR	47kΩ 1/16W J	
					R433	NRSA63J-473X	MG RESISTOR	47kΩ 1/16W J	
					R435	NRSA63J-473X	MG RESISTOR	47kΩ 1/16W J	
					R437	NRSA63J-473X	MG RESISTOR	47kΩ 1/16W J	
					R438	NRSA63J-473X	MG RESISTOR	47kΩ 1/16W J	
					R439	NRSA63J-473X	MG RESISTOR	47kΩ 1/16W J	
					R440	NRSA63J-473X	MG RESISTOR	47kΩ 1/16W J	
					R441	NRSA63J-473X	MG RESISTOR	47kΩ 1/16W J	
					R442	NRSA63J-473X	MG RESISTOR	47kΩ 1/16W J	
					R443	NRSA63J-222X	MG RESISTOR	2.2kΩ 1/16W J	
					R444	NRSA63J-473X	MG RESISTOR	47kΩ 1/16W J	
					R445	NRSA63J-563X	MG RESISTOR	56kΩ 1/16W J	
					R446	NRSA63J-473X	MG RESISTOR	47kΩ 1/16W J	
					R447	NRSA63J-473X	MG RESISTOR	47kΩ 1/16W J	
					R448	NRSA63J-683X	MG RESISTOR	68kΩ 1/16W J	
					R449	NRSA63J-103X	MG RESISTOR	10kΩ 1/16W J	
					R450	NRSA63J-473X	MG RESISTOR	47kΩ 1/16W J	
					R451	NRSA63J-473X	MG RESISTOR	47kΩ 1/16W J	
					R454	NRSA63J-473X	MG RESISTOR	47kΩ 1/16W J	
					R455	NRSA63J-102X	MG RESISTOR	1kΩ 1/16W J	
					R456	NRSA63J-102X	MG RESISTOR	1kΩ 1/16W J	

## Cassette mechanism control board (KW-XC400\_J)

Block No. [0][5]

△ Symbol No.	Part No.	Part Name	Description	Local
IC401	CXA2560Q	IC		
IC402	LB1641	IC		
IC431	UPD789166GB-590	IC		
IC432	BD4833FVE-W	IC		
IC461	SN74AHC126NS-X	IC		
Q402	RT1N141C-X	DIGI TRANSISTOR		
Q403	2SB1322/RS/-T	TRANSISTOR		
Q431	RT1N141C-X	DIGI TRANSISTOR		
Q432	2SC3928A/QR/-X	TRANSISTOR		
D401	MA8047/H/-X	Z DIODE		
D402	1A3G-T1	SI DIODE		

△ Symbol No.	Part No.	Part Name	Description	Local	△ Symbol No.	Part No.	Part Name	Description	Local
R457	NRSA63J-102X	MG RESISTOR	1kΩ 1/16W J		D905	CRS03-W	SB DIODE		
R458	NRSA63J-102X	MG RESISTOR	1kΩ 1/16W J		D921	MC2836-X	DIODE		
R461	NRSA63J-223X	MG RESISTOR	22kΩ 1/16W J		D951	1SS355W-X	DIODE C.M		
R462	NRSA63J-334X	MG RESISTOR	330kΩ 1/16W J		D952	UDZW11B-X	Z DIODE		
R463	NRSA63J-101X	MG RESISTOR	100Ω 1/16W J		D971	MC2838-X	DIODE		
R464	NRSA63J-104X	MG RESISTOR	100kΩ 1/16W J		D972	1SS355W-X	DIODE C.M		
R465	NRSA63J-223X	MG RESISTOR	22kΩ 1/16W J		D973	CRS03-W	SB DIODE		
R466	NRSA63J-104X	MG RESISTOR	100kΩ 1/16W J		D974	UDZW5.1B-X	SI DIODE		
R467	NRSA63J-103X	MG RESISTOR	10kΩ 1/16W J						
R468	NRSA63J-331X	MG RESISTOR	330Ω 1/16W J		C1	NCB31HK-103X	C CAPACITOR	0.01uF 50V K	
R469	NRSA63J-223X	MG RESISTOR	22kΩ 1/16W J		C2	QERF1AM-476Z	E CAPACITOR	47uF 10V M	
R470	NRSA63J-101X	MG RESISTOR	100Ω 1/16W J		C3	QERF1AM-476Z	E CAPACITOR	47uF 10V M	
R471	NRSA63J-334X	MG RESISTOR	330kΩ 1/16W J		C4	NCB31HK-103X	C CAPACITOR	0.01uF 50V K	
R491	NRSA63J-0R0X	MG RESISTOR	0Ω 1/16W J		C5	QERF1AM-227Z	E CAPACITOR	220uF 10V M	
VR401	QVP0033-333Z	TRIM RESISTOR	33kΩ		C6	QERF1AM-107Z	E CAPACITOR	100uF 10V M	
VR402	QVP0033-333Z	TRIM RESISTOR	33kΩ		C7	NCB31HK-103X	C CAPACITOR	0.01uF 50V K	
					C8	QERF1AM-107Z	E CAPACITOR	100uF 10V M	
L431	NQL114K-470X	COIL	47uH K		C9	QERF1HM-104Z	E CAPACITOR	0.1uF 50V M	
					C10	NCS31HJ-331X	C CAPACITOR	330pF 50V J	
CN401	QGB1004K1-16	CONNECTOR	B-B (1-16)		C12	NCB31HK-103X	C CAPACITOR	0.01uF 50V K	
CN402	QGA2001F1-06	CONNECTOR	W-B (1-6)		C101	NCB31HK-153X	C CAPACITOR	0.015uF 50V K	
CN403	QGF1205C2-10	CONNECTOR	FFC/FPC (1-10)		C102	QTE1H56-105Z	E CAPACITOR	1uF 50V	
X431	QAX0414-001Z	CRYSTAL	4.19430MHz		C141	NCB31CK-473X	C CAPACITOR	0.047uF 16V K	

## Main board (KW-XC407\_EE)

Block No. [0][6]

△ Symbol No.	Part No.	Part Name	Description	Local	△ Symbol No.	Part No.	Part Name	Description	Local
IC151	BD3807K	IC			C156	NCB31CK-104X	C CAPACITOR	0.1uF 16V K	
IC181	LA47516	POWER IC			C157	NCB31HK-103X	C CAPACITOR	0.01uF 50V K	
IC701	UPD784217AGC358	IC			C158	NCB31HK-103X	C CAPACITOR	0.01uF 50V K	
IC702	BR24L16F-W-X	IC			C159	QTE1A56-107Z	E CAPACITOR	100uF 10V	
IC703	S-80833CNNB-G-W	IC			C160	NCB31CK-473X	C CAPACITOR	0.047uF 16V K	
IC781	SN74AHC126NS-X	IC			C161	QTE1C56-106Z	E CAPACITOR	10uF 16V	
IC901	R2S25400DS-E	REGULATOR IC			C162	QERF1EM-475Z	E CAPACITOR	4.7uF 25V M	
					C163	QERF1EM-475Z	E CAPACITOR	4.7uF 25V M	
Q1	2SA1365/F/-X	TRANSISTOR			C164	QTE1E56-475Z	E CAPACITOR	4.7uF 25V	
Q2	2SA1365/F/-X	TRANSISTOR			C165	QTE1E56-475Z	E CAPACITOR	4.7uF 25V	
Q3	RT1N141C-X	DIGI TRANSISTOR			C181	QFV91HJ-474Z	MF CAPACITOR	0.47uF 50V J	
Q181	RT1N441C-X	TRANSISTOR			C182	QFV91HJ-474Z	MF CAPACITOR	0.47uF 50V J	
Q701	RT1N441C-X	TRANSISTOR			C183	NDC31HJ-101X	C CAPACITOR	100pF 50V J	
Q702	RT1N441C-X	TRANSISTOR			C184	NDC31HJ-101X	C CAPACITOR	100pF 50V J	
Q703	RT1N141C-X	DIGI TRANSISTOR			C185	NCB31CK-104X	C CAPACITOR	0.1uF 16V K	
Q704	RT1N141C-X	DIGI TRANSISTOR			C186	NCB31CK-104X	C CAPACITOR	0.1uF 16V K	
Q705	RT1N441C-X	TRANSISTOR			C187	NDC31HJ-101X	C CAPACITOR	100pF 50V J	
Q706	RT1N141C-X	DIGI TRANSISTOR			C188	NDC31HJ-101X	C CAPACITOR	100pF 50V J	
Q707	RT1N141C-X	DIGI TRANSISTOR			C189	NDC31HJ-101X	C CAPACITOR	100pF 50V J	
Q708	RT1N141C-X	DIGI TRANSISTOR			C190	NDC31HJ-101X	C CAPACITOR	100pF 50V J	
Q901	2SA1365/F/-X	TRANSISTOR			C191	NCB31HK-223X	C CAPACITOR	0.022uF 50V K	
Q902	RT1N141C-X	DIGI TRANSISTOR			C192	QTE1C56-476Z	E CAPACITOR	47uF 16V	
Q903	2SA1530A/QR/-X	TRANSISTOR			C193	QERF1CM-226Z	E CAPACITOR	22uF 16V M	
Q904	2SA1365/F/-X	TRANSISTOR			C194	NCB31HK-223X	C CAPACITOR	0.022uF 50V K	
Q905	RT1N141C-X	DIGI TRANSISTOR			C195	QERF1HM-225Z	E CAPACITOR	2.2uF 50V M	
Q921	2SC3928A/QR/-X	TRANSISTOR			C196	QERF1EM-475Z	E CAPACITOR	4.7uF 25V M	
Q922	RT1N141C-X	DIGI TRANSISTOR			C197	QERF1HM-105Z	E CAPACITOR	1uF 50V M	
Q951	RT1P141C-X	DIGI TRANSISTOR			C198	QERF1HM-105Z	E CAPACITOR	1uF 50V M	
Q952	RT1P141C-X	DIGI TRANSISTOR			C201	NCB31HK-153X	C CAPACITOR	0.015uF 50V K	
Q971	2SC3928A/QR/-X	TRANSISTOR			C202	QTE1H56-105Z	E CAPACITOR	1uF 50V	
					C251	QTE1H55-225Z	E CAPACITOR	2.2uF 50V	
D1	1SS355W-X	DIODE C.M			C252	QTE1H56-225Z	E CAPACITOR	2.2uF 50V	
D2	1SS355W-X	DIODE C.M			C253	QERF1HM-225Z	E CAPACITOR	2.2uF 50V M	
D3	MC2838-X	DIODE			C254	QERF1HM-225Z	E CAPACITOR	2.2uF 50V M	
D181	1SS355W-X	DIODE C.M			C255	NCB31HK-221X	C CAPACITOR	220pF 50V K	
D182	1SS355W-X	DIODE C.M			C256	NCB31CK-104X	C CAPACITOR	0.1uF 16V K	
D701	1SS355W-X	DIODE C.M			C257	NCB31HK-103X	C CAPACITOR	0.01uF 50V K	
D713	UDZW6.2B-X	DIODE			C258	NCB31HK-103X	C CAPACITOR	0.01uF 50V K	
D714	UDZW6.2B-X	DIODE			C259	NCB31CK-224X	C CAPACITOR	0.22uF 16V K	
D715	UDZW6.2B-X	DIODE			C263	QERF1EM-475Z	E CAPACITOR	4.7uF 25V M	
D716	UDZW6.2B-X	DIODE			C264	QTE1E56-475Z	E CAPACITOR	4.7uF 25V	
D718	1SS355W-X	DIODE C.M			C265	QTE1E56-475Z	E CAPACITOR	4.7uF 25V	
D901	1N5401-F64	DIODE			C281	QFV91HJ-474Z	MF CAPACITOR	0.47uF 50V J	
D903	1SS355W-X	DIODE C.M			C282	QFV91HJ-474Z	MF CAPACITOR	0.47uF 50V J	
D904	CRS03-W	SB DIODE			C283	NDC31HJ-101X	C CAPACITOR	100pF 50V J	
					C284	NDC31HJ-101X	C CAPACITOR	100pF 50V J	
					C285	NCB31CK-104X	C CAPACITOR	0.1uF 16V K	
					C286	NCB31CK-104X	C CAPACITOR	0.1uF 16V K	
					C287	NDC31HJ-101X	C CAPACITOR	100pF 50V J	
					C288	NDC31HJ-101X	C CAPACITOR	100pF 50V J	



△ Symbol No.	Part No.	Part Name	Description	Local	△ Symbol No.	Part No.	Part Name	Description	Local
C289	NDC31HJ-101X	C CAPACITOR	100pF 50V J		R193	NRSA63J-0R0X	MG RESISTOR	0Ω 1/16W J	
C290	NDC31HJ-101X	C CAPACITOR	100pF 50V J		R195	NRSA63J-182X	MG RESISTOR	1.8kΩ 1/16W J	
C701	NDC31HJ-8R0X	C CAPACITOR	8pF 50V J		R201	NRSA63J-123X	MG RESISTOR	12kΩ 1/16W J	
C702	NDC31HJ-270X	C CAPACITOR	27pF 50V J		R202	NRSA63J-273X	MG RESISTOR	27kΩ 1/16W J	
C703	NDC31HJ-270X	C CAPACITOR	27pF 50V J		R241	NRSA63J-104X	MG RESISTOR	100kΩ 1/16W J	
C704	NDC31HJ-220X	C CAPACITOR	22pF 50V J		R242	NRSA63J-101X	MG RESISTOR	100Ω 1/16W J	
C705	NCB31HK-103X	C CAPACITOR	0.01uF 50V K		R251	NRSA63J-473X	MG RESISTOR	47kΩ 1/16W J	
C706	NCB31HK-103X	C CAPACITOR	0.01uF 50V K		R252	NRSA63J-472X	MG RESISTOR	4.7kΩ 1/16W J	
C708	QERF0JM-476Z	E CAPACITOR	47uF 6.3V M		R254	NRSA63J-473X	MG RESISTOR	47kΩ 1/16W J	
C710	QERF1AM-227Z	E CAPACITOR	220uF 10V M		R255	NRSA63J-473X	MG RESISTOR	47kΩ 1/16W J	
C711	QERF1AM-227Z	E CAPACITOR	220uF 10V M		R256	NRSA63J-333X	MG RESISTOR	33kΩ 1/16W J	
C712	QERF1AM-227Z	E CAPACITOR	220uF 10V M		R281	NRSA63J-273X	MG RESISTOR	27kΩ 1/16W J	
C713	NCB31CK-473X	C CAPACITOR	0.047uF 16V K		R282	NRSA63J-273X	MG RESISTOR	27kΩ 1/16W J	
C714	NCB31CK-104X	C CAPACITOR	0.1uF 16V K		R701	NRSA63J-102X	MG RESISTOR	1kΩ 1/16W J	
C715	NCB31HK-103X	C CAPACITOR	0.01uF 50V K		R703	NRSA63J-821X	MG RESISTOR	820Ω 1/16W J	
C716	NDC31HJ-101X	C CAPACITOR	100pF 50V J		R704	NRSA63J-473X	MG RESISTOR	47kΩ 1/16W J	
C717	NCB31HK-103X	C CAPACITOR	0.01uF 50V K		R705	NRSA63J-106X	MG RESISTOR	10MΩ 1/16W J	
C720	NCB31HK-103X	C CAPACITOR	0.01uF 50V K		R706	NRSA63J-101X	MG RESISTOR	100Ω 1/16W J	
C721	NCB31HK-103X	C CAPACITOR	0.01uF 50V K		R707	NRSA63J-473X	MG RESISTOR	47kΩ 1/16W J	
C722	NCB31HK-103X	C CAPACITOR	0.01uF 50V K		R708	NRSA63J-222X	MG RESISTOR	2.2kΩ 1/16W J	
C723	NCB31HK-103X	C CAPACITOR	0.01uF 50V K		R709	NRSA63J-102X	MG RESISTOR	1kΩ 1/16W J	
C724	NCB31HK-103X	C CAPACITOR	0.01uF 50V K		R710	NRSA63J-102X	MG RESISTOR	1kΩ 1/16W J	
C725	NCB31CK-104X	C CAPACITOR	0.1uF 16V K		R712	NRSA63J-102X	MG RESISTOR	1kΩ 1/16W J	
C726	NCB31CK-104X	C CAPACITOR	0.1uF 16V K		R713	NRSA63J-473X	MG RESISTOR	47kΩ 1/16W J	
C727	NCB31CK-104X	C CAPACITOR	0.1uF 16V K		R714	NRSA63J-102X	MG RESISTOR	1kΩ 1/16W J	
C728	NCB31CK-104X	C CAPACITOR	0.1uF 16V K		R715	NRSA63J-473X	MG RESISTOR	47kΩ 1/16W J	
C730	NCB31HK-103X	C CAPACITOR	0.01uF 50V K		R716	NRSA63J-102X	MG RESISTOR	1kΩ 1/16W J	
C731	NCB31HK-103X	C CAPACITOR	0.01uF 50V K		R717	NRSA63J-473X	MG RESISTOR	47kΩ 1/16W J	
C732	NCB31HK-103X	C CAPACITOR	0.01uF 50V K		R718	NRSA63J-222X	MG RESISTOR	2.2kΩ 1/16W J	
C733	NCB31HK-103X	C CAPACITOR	0.01uF 50V K		R719	NRSA63J-223X	MG RESISTOR	22kΩ 1/16W J	
C735	NDC31HJ-101X	C CAPACITOR	100pF 50V J		R720	NRSA63J-103X	MG RESISTOR	10kΩ 1/16W J	
C736	NDC31HJ-101X	C CAPACITOR	100pF 50V J		R721	NRSA63J-332X	MG RESISTOR	3.3kΩ 1/16W J	
C781	NCB31CK-473X	C CAPACITOR	0.047uF 16V K		R722	NRSA63J-103X	MG RESISTOR	10kΩ 1/16W J	
C901	QEZ0676-338	E CAPACITOR	3300uF		R723	NRSA63J-332X	MG RESISTOR	3.3kΩ 1/16W J	
C902	QERF1HM-225Z	E CAPACITOR	2.2uF 50V M		R724	NRSA63J-103X	MG RESISTOR	10kΩ 1/16W J	
C903	QERF1CM-226Z	E CAPACITOR	22uF 16V M		R725	NRSA63J-332X	MG RESISTOR	3.3kΩ 1/16W J	
C904	QERF1CM-226Z	E CAPACITOR	22uF 16V M		R726	NRSA63J-102X	MG RESISTOR	1kΩ 1/16W J	
C905	NCB31HK-103X	C CAPACITOR	0.01uF 50V K		R727	NRSA63J-102X	MG RESISTOR	1kΩ 1/16W J	
C906	QERF1AM-227Z	E CAPACITOR	220uF 10V M		R728	NRSA63J-102X	MG RESISTOR	1kΩ 1/16W J	
C907	NCB31CK-104X	C CAPACITOR	0.1uF 16V K		R731	NRSA63J-0R0X	MG RESISTOR	0Ω 1/16W J	
C908	NCB31CK-104X	C CAPACITOR	0.1uF 16V K		R732	NRSA63J-473X	MG RESISTOR	47kΩ 1/16W J	
C909	QERF1AM-227Z	E CAPACITOR	220uF 10V M		R733	NRSA63J-102X	MG RESISTOR	1kΩ 1/16W J	
C911	QERF1CM-106Z	E CAPACITOR	10uF 16V M		R734	NRSA63J-102X	MG RESISTOR	1kΩ 1/16W J	
C912	NCB31CK-104X	C CAPACITOR	0.1uF 16V K		R739	NRSA63J-222X	MG RESISTOR	2.2kΩ 1/16W J	
C921	QERF1CM-226Z	E CAPACITOR	22uF 16V M		R740	NRSA63J-222X	MG RESISTOR	2.2kΩ 1/16W J	
C922	NCB31CK-104X	C CAPACITOR	0.1uF 16V K		R741	NRSA63J-222X	MG RESISTOR	2.2kΩ 1/16W J	
C951	QERF1AM-107Z	E CAPACITOR	100uF 10V M		R743	NRSA63J-102X	MG RESISTOR	1kΩ 1/16W J	
C952	QERF1CM-107Z	E CAPACITOR	100uF 16V M		R744	NRSA63J-102X	MG RESISTOR	1kΩ 1/16W J	
C953	NCB31CK-104X	C CAPACITOR	0.1uF 16V K		R745	NRSA63J-103X	MG RESISTOR	10kΩ 1/16W J	
C971	QERF1HM-105Z	E CAPACITOR	1uF 50V M		R746	NRSA63J-271X	MG RESISTOR	270Ω 1/16W J	
C972	QERF1CM-226Z	E CAPACITOR	22uF 16V M		R747	NRSA63J-271X	MG RESISTOR	270Ω 1/16W J	
C973	NCB31EK-473X	C CAPACITOR	0.047uF 25V K		R748	NRSA63J-0R0X	MG RESISTOR	0Ω 1/16W J	
C974	NCB31CK-224X	C CAPACITOR	0.22uF 16V K		R749	NRSA63J-0R0X	MG RESISTOR	0Ω 1/16W J	
R1	NRSA63J-103X	MG RESISTOR	10kΩ 1/16W J		R751	NRSA63J-102X	MG RESISTOR	1kΩ 1/16W J	
R2	NRSA63J-222X	MG RESISTOR	2.2kΩ 1/16W J		R752	NRSA63J-102X	MG RESISTOR	1kΩ 1/16W J	
R3	NRSA63J-103X	MG RESISTOR	10kΩ 1/16W J		R753	NRSA63J-102X	MG RESISTOR	1kΩ 1/16W J	
R4	NRSA63J-102X	MG RESISTOR	1kΩ 1/16W J		R754	NRSA63J-473X	MG RESISTOR	47kΩ 1/16W J	
R5	NRS181J-100X	MG RESISTOR	10Ω 1/8W J		R755	NRSA63J-473X	MG RESISTOR	47kΩ 1/16W J	
R7	NRS181J-4R7X	MG RESISTOR	4.7Ω 1/8W J		R756	NRSA63J-222X	MG RESISTOR	2.2kΩ 1/16W J	
R8	NRSA63J-473X	MG RESISTOR	47kΩ 1/16W J		R758	NRSA63J-102X	MG RESISTOR	1kΩ 1/16W J	
R9	NRSA63J-270X	MG RESISTOR	27Ω 1/16W J		R759	NRSA63J-473X	MG RESISTOR	47kΩ 1/16W J	
R10	NRSA63J-103X	MG RESISTOR	10kΩ 1/16W J		R760	NRSA63J-102X	MG RESISTOR	1kΩ 1/16W J	
R11	NRSA63J-393X	MG RESISTOR	39kΩ 1/16W J		R762	NRSA63J-102X	MG RESISTOR	1kΩ 1/16W J	
R101	NRSA63J-123X	MG RESISTOR	12kΩ 1/16W J		R763	NRSA63J-102X	MG RESISTOR	1kΩ 1/16W J	
R102	NRSA63J-273X	MG RESISTOR	27kΩ 1/16W J		R764	NRSA63J-473X	MG RESISTOR	47kΩ 1/16W J	
R141	NRSA63J-104X	MG RESISTOR	100kΩ 1/16W J		R765	NRSA63J-102X	MG RESISTOR	1kΩ 1/16W J	
R142	NRSA63J-101X	MG RESISTOR	100Ω 1/16W J		R766	NRSA63J-102X	MG RESISTOR	1kΩ 1/16W J	
R151	NRSA63J-473X	MG RESISTOR	47kΩ 1/16W J		R767	NRSA63J-473X	MG RESISTOR	47kΩ 1/16W J	
R152	NRSA63J-472X	MG RESISTOR	4.7kΩ 1/16W J		R768	NRSA63J-102X	MG RESISTOR	1kΩ 1/16W J	
R153	NRSA63J-333X	MG RESISTOR	33kΩ 1/16W J		R769	NRSA63J-473X	MG RESISTOR	47kΩ 1/16W J	
R154	NRSA63J-473X	MG RESISTOR	47kΩ 1/16W J		R770	NRSA63J-473X	MG RESISTOR	47kΩ 1/16W J	
R155	NRSA63J-473X	MG RESISTOR	47kΩ 1/16W J		R772	NRSA63J-473X	MG RESISTOR	47kΩ 1/16W J	
R156	NRSA63J-333X	MG RESISTOR	33kΩ 1/16W J		R775	NRSA63J-473X	MG RESISTOR	47kΩ 1/16W J	
R181	NRSA63J-273X	MG RESISTOR	27kΩ 1/16W J		R776	NRSA63J-102X	MG RESISTOR	1kΩ 1/16W J	
R182	NRSA63J-273X	MG RESISTOR	27kΩ 1/16W J		R777	NRSA63J-473X	MG RESISTOR	47kΩ 1/16W J	
R191	NRSA63J-222X	MG RESISTOR	2.2kΩ 1/16W J		R778	NRSA63J-102X	MG RESISTOR	1kΩ 1/16W J	
R192	NRSA63J-273X	MG RESISTOR	27kΩ 1/16W J		R779	NRSA63J-103X	MG RESISTOR	10kΩ 1/16W J	
					R781	NRSA63J-104X	MG RESISTOR	100kΩ 1/16W J	

Symbol No.	Part No.	Part Name	Description	Local
R782	NRSA63J-223X	MG RESISTOR	22kΩ 1/16W J	
R783	NRSA63J-101X	MG RESISTOR	100Ω 1/16W J	
R784	NRSA63J-473X	MG RESISTOR	47kΩ 1/16W J	
R785	NRSA63J-101X	MG RESISTOR	100Ω 1/16W J	
R786	NRSA63J-473X	MG RESISTOR	47kΩ 1/16W J	
R787	NRSA63J-223X	MG RESISTOR	22kΩ 1/16W J	
R788	NRSA63J-331X	MG RESISTOR	330Ω 1/16W J	
R789	NRSA63J-104X	MG RESISTOR	100kΩ 1/16W J	
R790	NRSA63J-103X	MG RESISTOR	10kΩ 1/16W J	
R901	QRE142J-102X	C RESISTOR	1kΩ 1/4W J	
R902	NRSA63J-912X	MG RESISTOR	9.1kΩ 1/16W J	
R903	NRSA63J-472X	MG RESISTOR	4.7kΩ 1/16W J	
R904	NRSA63J-562X	MG RESISTOR	5.6kΩ 1/16W J	
R905	NRSA63J-102X	MG RESISTOR	1kΩ 1/16W J	
R906	NRSA63J-103X	MG RESISTOR	10kΩ 1/16W J	
R907	NRSA63J-473X	MG RESISTOR	47kΩ 1/16W J	
R908	NRSA63J-473X	MG RESISTOR	47kΩ 1/16W J	
R909	NRSA63J-473X	MG RESISTOR	47kΩ 1/16W J	
R910	NRSA63J-153X	MG RESISTOR	15kΩ 1/16W J	
R911	NRSA63J-473X	MG RESISTOR	47kΩ 1/16W J	
R912	NRS181J-102X	MG RESISTOR	1kΩ 1/8W J	
R915	NRSA63J-473X	MG RESISTOR	47kΩ 1/16W J	
R916	NRSA63J-222X	MG RESISTOR	2.2kΩ 1/16W J	
R921	NRSA63J-473X	MG RESISTOR	47kΩ 1/16W J	
R922	NRSA63J-472X	MG RESISTOR	4.7kΩ 1/16W J	
R923	NRSA63J-104X	MG RESISTOR	100kΩ 1/16W J	
R924	NRSA63J-473X	MG RESISTOR	47kΩ 1/16W J	
R925	NRSA63J-102X	MG RESISTOR	1kΩ 1/16W J	
R971	NRSA63J-224X	MG RESISTOR	220kΩ 1/16W J	
R972	NRSA63J-224X	MG RESISTOR	220kΩ 1/16W J	
R973	NRSA63J-473X	MG RESISTOR	47kΩ 1/16W J	
R974	NRSA63J-184X	MG RESISTOR	180kΩ 1/16W J	
R975	NRSA63J-223X	MG RESISTOR	22kΩ 1/16W J	
R976	NRSA63J-123X	MG RESISTOR	12kΩ 1/16W J	
R977	NRSA63J-470X	MG RESISTOR	47Ω 1/16W J	
R978	NRSA63J-102X	MG RESISTOR	1kΩ 1/16W J	
R979	NRSA63J-124X	MG RESISTOR	120kΩ 1/16W J	
R980	NRSA63J-123X	MG RESISTOR	12kΩ 1/16W J	
RA701	NRZ0065-102X	NET RESISTOR	1kΩ 1/16W J	
RA702	NRZ0065-102X	NET RESISTOR	1kΩ 1/16W J	

L1	QQL244J-4R7Z	COIL	4.7uH J	
L701	QQL244J-470Z	COIL	47uH J	
L702	QQL244J-470Z	COIL	47uH J	
L703	QQL244J-470Z	COIL	47uH J	
L704	NQL114M-4R7X	COIL	4.7uH M	
L781	NQL093K-1R8X	COIL	1.8uH K	
L782	NQL093K-1R8X	COIL	1.8uH K	
L901	QQR0703-001	CHOKE COIL		

CN323	QGA2001F1-07	CONNECTOR	W-B (1-7)	
CN701	QGB1004K1-20	CONNECTOR	B-B (1-20)	
CN702	QGB1004K1-16	CONNECTOR	B-B (1-16)	
CN704	QGA2006F1-02	CONNECTOR	W-B (1-2)	
CN705	QGB2027M4-22S	CONNECTOR	B-B (1-22)	
CN901	QNZ0611-001	16P CONNECTOR		
CN902	QNZ0095-001	CONNECTOR		
J1	QNB0190-001	ANTENNA JACK		
PP1	QZW0010-001	STYLE PIN		
TU1	QAU0403-001	TUNER PACK		
X701	QAX0617-001Z	CRYSTAL	12.500MHz	
X702	QAX0401-001	CRYSTAL	32.768KHz	

## Func board (KW-XC407\_EE)

Block No. [0][7]

Symbol No.	Part No.	Part Name	Description	Local
Q321	KTD1304-X	TRANSISTOR		
Q331	KTD1304-X	TRANSISTOR		
Q341	KTD1304-X	TRANSISTOR		
Q351	KTD1304-X	TRANSISTOR		
D321	MC2836-X	DIODE		

Symbol No.	Part No.	Part Name	Description	Local
D331	MC2836-X	DIODE		
R321	NRSA63J-821X	MG RESISTOR	820Ω 1/16W J	
R322	NRSA63J-181X	MG RESISTOR	180Ω 1/16W J	
R325	NRSA63J-222X	MG RESISTOR	2.2kΩ 1/16W J	
R331	NRSA63J-821X	MG RESISTOR	820Ω 1/16W J	
R332	NRSA63J-181X	MG RESISTOR	180Ω 1/16W J	
R335	NRSA63J-222X	MG RESISTOR	2.2kΩ 1/16W J	
R341	NRSA63J-821X	MG RESISTOR	820Ω 1/16W J	
R342	NRSA63J-181X	MG RESISTOR	180Ω 1/16W J	
R345	NRSA63J-222X	MG RESISTOR	2.2kΩ 1/16W J	
R351	NRSA63J-821X	MG RESISTOR	820Ω 1/16W J	
R352	NRSA63J-181X	MG RESISTOR	180Ω 1/16W J	
R355	NRSA63J-222X	MG RESISTOR	2.2kΩ 1/16W J	
CN322	QGA2001F1-07	CONNECTOR	W-B (1-7)	
J321	QNN0746-001	PIN JACK		

## Switch board (KW-XC407\_EE)

Block No. [0][8]

Symbol No.	Part No.	Part Name	Description	Local
IC801	PT6578LQ-L	IC		
IC802	RPM7338-V4	RM.RECEIVER		
D801	UDZW5.1B-X	SI DIODE		
D802	UDZW9.1B-X	Z DIODE		
D803	1SS355W-X	DIODE C.M		
D804	1SS355W-X	DIODE C.M		
D805	1SS355W-X	DIODE C.M		
D806	1SS355W-X	DIODE C.M		
D807	1SS355W-X	DIODE C.M		
D808	1SS355W-X	DIODE C.M		
D809	1SS355W-X	DIODE C.M		
D811	NSPW310BS/BRST/	LED		
D812	NSPW310BS/BRST/	LED		
D813	NSPW310BS/BRST/	LED		
D814	TO1608BCHC/Z/-X	LED		
D815	LNJ308G81/1-3/X	LED		
D816	LNJ308G81/1-3/X	LED		
D817	LNJ308G81/1-3/X	LED		
D818	LNJ308G81/1-3/X	LED		
D819	LNJ308G81/1-3/X	LED		
D820	LNJ308G81/1-3/X	LED		
D821	LNJ308G81/1-3/X	LED		
D822	LNJ308G81/1-3/X	LED		
D823	LNJ308G81/1-3/X	LED		
D824	LNJ308G81/1-3/X	LED		
D825	LNJ308G81/1-3/X	LED		
D826	LNJ308G81/1-3/X	LED		
D827	LNJ308G81/1-3/X	LED		
D828	LNJ308G81/1-3/X	LED		
D829	LNJ308G81/1-3/X	LED		
D830	LNJ308G81/1-3/X	LED		
D831	LNJ308G81/1-3/X	LED		
D832	LNJ308G81/1-3/X	LED		
D833	LNJ308G81/1-3/X	LED		
D834	LNJ308G81/1-3/X	LED		
D835	LNJ308G81/1-3/X	LED		
D836	LNJ308G81/1-3/X	LED		
D837	LNJ308G81/1-3/X	LED		
D838	LNJ308G81/1-3/X	LED		
D839	LNJ308G81/1-3/X	LED		
D840	MC2838-X	DIODE		
D841	UDZW5.1B-X	SI DIODE		
C801	NCB31CK-104X	C CAPACITOR	0.1uF 16V K	
C802	NCB31CK-104X	C CAPACITOR	0.1uF 16V K	
C803	NCB31CK-104X	C CAPACITOR	0.1uF 16V K	
C804	NCB31CK-104X	C CAPACITOR	0.1uF 16V K	
C805	NCS31HJ-681X	C CAPACITOR	680pF 50V J	
C806	NBE20JM-475X	TA E CAPACITOR	4.7uF 6.3V M	
C807	NBE21CM-475X	TA E CAPACITOR	4.7uF 16V M	

△ Symbol No.	Part No.	Part Name	Description	Local	△ Symbol No.	Part No.	Part Name	Description	Local
C808	NBE20JM-475X	TA E CAPACITOR	4.7uF 6.3V M		S858	NSW0246-001X	TACK SW		
C809	NBE20JM-475X	TA E CAPACITOR	4.7uF 6.3V M		S859	NSW0246-001X	TACK SW		
C810	NCB31HK-472X	C CAPACITOR	4700pF 50V K		S860	NSW0246-001X	TACK SW		
C811	NCB31HK-472X	C CAPACITOR	4700pF 50V K		S861	NSW0246-001X	TACK SW		
C812	NCB31CK-473X	C CAPACITOR	0.047uF 16V K		S862	NSW0246-001X	TACK SW		
C813	NCB31HK-103X	C CAPACITOR	0.01uF 50V K		S863	NSW0246-001X	TACK SW		
C814	NCB31HK-103X	C CAPACITOR	0.01uF 50V K		S864	NSW0246-001X	TACK SW		
R801	NRS181J-182X	MG RESISTOR	1.8kΩ 1/8W J		S865	NSW0246-001X	TACK SW		
R802	NRSA63J-221X	MG RESISTOR	220Ω 1/16W J		S866	NSW0246-001X	TACK SW		
R803	NRSA63J-821X	MG RESISTOR	820Ω 1/16W J		S867	NSW0246-001X	TACK SW		
R804	NRSA63J-103X	MG RESISTOR	10kΩ 1/16W J		S868	NSW0246-001X	TACK SW		
R805	NRSA63J-103X	MG RESISTOR	10kΩ 1/16W J		S869	NSW0246-001X	TACK SW		
R806	NRSA63J-103X	MG RESISTOR	10kΩ 1/16W J		S870	NSW0246-001X	TACK SW		
R807	NRSA63J-103X	MG RESISTOR	10kΩ 1/16W J		S871	NSW0246-001X	TACK SW		
R808	NRSA63J-332X	MG RESISTOR	3.3kΩ 1/16W J		TH855	NAD0028-103X	N THERMISTOR	10kΩ	
R809	NRSA63J-332X	MG RESISTOR	3.3kΩ 1/16W J						
R810	NRSA63J-332X	MG RESISTOR	3.3kΩ 1/16W J						
R811	NRSA63J-683X	MG RESISTOR	68kΩ 1/16W J						
R812	NRSA63J-394X	MG RESISTOR	390kΩ 1/16W J						
R814	NRS181J-391X	MG RESISTOR	390Ω 1/8W J						
R816	NRS181J-391X	MG RESISTOR	390Ω 1/8W J						
R818	NRS181J-391X	MG RESISTOR	390Ω 1/8W J						
R820	NRSA02J-821X	MG RESISTOR	820Ω 1/10W J						
R822	NRSA02J-821X	MG RESISTOR	820Ω 1/10W J						
R824	NRSA02J-471X	MG RESISTOR	470Ω 1/10W J						
R826	NRSA02J-471X	MG RESISTOR	470Ω 1/10W J						
R828	NRSA02J-331X	MG RESISTOR	330Ω 1/10W J						
R830	NRSA02J-331X	MG RESISTOR	330Ω 1/10W J						
R832	NRSA02J-331X	MG RESISTOR	330Ω 1/10W J						
R834	NRSA02J-331X	MG RESISTOR	330Ω 1/10W J						
R836	NRSA02J-331X	MG RESISTOR	330Ω 1/10W J						
R838	NRSA02J-331X	MG RESISTOR	330Ω 1/10W J						
R840	NRSA02J-331X	MG RESISTOR	330Ω 1/10W J						
R842	NRSA02J-471X	MG RESISTOR	470Ω 1/10W J						
R844	NRSA02J-471X	MG RESISTOR	470Ω 1/10W J						
R846	NRSA02J-331X	MG RESISTOR	330Ω 1/10W J						
R848	NRSA02J-331X	MG RESISTOR	330Ω 1/10W J						
R850	NRSA02J-471X	MG RESISTOR	470Ω 1/10W J						
R852	NRSA02J-331X	MG RESISTOR	330Ω 1/10W J						
R853	NRSA63J-103X	MG RESISTOR	10kΩ 1/16W J						
R854	NRSA63J-471X	MG RESISTOR	470Ω 1/16W J						
R855	NRSA63J-103X	MG RESISTOR	10kΩ 1/16W J						
R856	NRSA63J-473X	MG RESISTOR	47kΩ 1/16W J						
R857	NRSA63J-473X	MG RESISTOR	47kΩ 1/16W J						
R859	NRSA63J-0R0X	MG RESISTOR	0Ω 1/16W J						
R860	NRSA63J-0R0X	MG RESISTOR	0Ω 1/16W J						
R863	NRSA63J-332X	MG RESISTOR	3.3kΩ 1/16W J						
R871	NRSA63J-621X	MG RESISTOR	620Ω 1/16W J						
R872	NRSA63J-621X	MG RESISTOR	620Ω 1/16W J						
R873	NRSA63J-821X	MG RESISTOR	820Ω 1/16W J						
R874	NRSA63J-122X	MG RESISTOR	1.2kΩ 1/16W J						
R875	NRSA63J-621X	MG RESISTOR	620Ω 1/16W J						
R876	NRSA63J-621X	MG RESISTOR	620Ω 1/16W J						
R877	NRSA63J-821X	MG RESISTOR	820Ω 1/16W J						
R878	NRSA63J-122X	MG RESISTOR	1.2kΩ 1/16W J						
R879	NRSA63J-182X	MG RESISTOR	1.8kΩ 1/16W J						
R880	NRSA63J-302X	MG RESISTOR	3kΩ 1/16W J						
R881	NRSA63J-562X	MG RESISTOR	5.6kΩ 1/16W J						
R882	NRSA63J-621X	MG RESISTOR	620Ω 1/16W J						
R883	NRSA63J-621X	MG RESISTOR	620Ω 1/16W J						
R884	NRSA63J-821X	MG RESISTOR	820Ω 1/16W J						
R885	NRSA63J-122X	MG RESISTOR	1.2kΩ 1/16W J						
R886	NRSA63J-182X	MG RESISTOR	1.8kΩ 1/16W J						
R887	NRSA63J-302X	MG RESISTOR	3kΩ 1/16W J						
CN801	QGB1004J2-20X	CONNECTOR	B-B (1-20)						
CN802	QGB1004J2-16X	CONNECTOR	B-B (1-16)						
CN803	QGB1004J2-16X	CONNECTOR	B-B (1-16)						
EN851	QSW0976-001	ROTARY ENCODER							
PJ801	QNS0180-002	3.5 JACK							
S851	NSW0246-001X	TACK SW							
S852	NSW0246-001X	TACK SW							
S853	NSW0246-001X	TACK SW							
S854	NSW0246-001X	TACK SW							
S855	NSW0246-001X	TACK SW							
S856	NSW0246-001X	TACK SW							
S857	NSW0246-001X	TACK SW							
S858	NSW0246-001X	TACK SW							
S859	NSW0246-001X	TACK SW							
S860	NSW0246-001X	TACK SW							
S861	NSW0246-001X	TACK SW							
S862	NSW0246-001X	TACK SW							
S863	NSW0246-001X	TACK SW							
S864	NSW0246-001X	TACK SW							
S865	NSW0246-001X	TACK SW							
S866	NSW0246-001X	TACK SW							
S867	NSW0246-001X	TACK SW							
S868	NSW0246-001X	TACK SW							
S869	NSW0246-001X	TACK SW							
S870	NSW0246-001X	TACK SW							
S871	NSW0246-001X	TACK SW							
TH855	NAD0028-103X	N THERMISTOR						10kΩ	

## CD mechanism control board (KW-XC407\_EE)

Block No. [0][9]

△ Symbol No.	Part No.	Part Name	Description	Local
IC501	TMP91CW12AF5VD9	IC		
IC502	BR24L01AFV-W-X	IC		
IC503	SN74AHCT126PW-X	IC(DIGITAL)		
IC504	NJU7241F33-X	IC		
IC571	PCM1753-X	IC		
IC572	NJM4580V-X	IC		
IC573	SN74AHC04PW-X	IC		
IC601	TA2157FN-X	RF AMP IC		
IC621	TC94A14FA	IC		
IC651	NJU7772F15-X	IC		
IC652	TC94A34FG-002	IC		
IC681	BA5830FP-X	IC		
Q501	RT1P141C-X	DIGI TRANSISTOR		
Q502	RT1N141C-X	DIGI TRANSISTOR		
Q571	RT1P141C-X	DIGI TRANSISTOR		
Q572	RT1N141C-X	DIGI TRANSISTOR		
Q573	2SA1365/F/-X	TRANSISTOR		
Q574	RT1N141C-X	DIGI TRANSISTOR		
Q601	2SA1947/E/-X	CHIP.TR.C.M		
Q651	2SA1365/F/-X	TRANSISTOR		
Q652	RT1N141C-X	DIGI TRANSISTOR		
Q681	2SB1184/QR/-X	TRANSISTOR		
D506	1SS355W-X	DIODE C.M		
D682	1SR154-400-X	DIODE		
C501	NCB31HK-103X	C CAPACITOR	0.01uF 50V K	
C502	NCB31HK-103X	C CAPACITOR	0.01uF 50V K	
C503	NEAG0JM-107X	E CAPACITOR	100uF 6.3V M	
C504	NDC31HJ-220X	C CAPACITOR	22pF 50V J	
C505	NDC31HJ-220X	C CAPACITOR	22pF 50V J	
C506	NCB31HK-103X	C CAPACITOR	0.01uF 50V K	
C507	NCB31HK-103X	C CAPACITOR	0.01uF 50V K	
C508	NCB31HK-103X	C CAPACITOR	0.01uF 50V K	
C509	NCB31HK-103X	C CAPACITOR	0.01uF 50V K	
C510	NCB31HK-103X	C CAPACITOR	0.01uF 50V K	
C511	NCB31CK-104X	C CAPACITOR	0.1uF 16V K	
C512	NEAG0JM-107X	E CAPACITOR	100uF 6.3V M	
C513	NCB31HK-103X	C CAPACITOR	0.01uF 50V K	
C514	NCS31HJ-102X	C CAPACITOR	1000pF 50V J	
C551	NCB31HK-103X	C CAPACITOR	0.01uF 50V K	
C561	NCB31HK-123X	C CAPACITOR	0.012uF 50V K	
C571	NDC31HJ-270X	C CAPACITOR	27pF 50V J	
C572	NDC31HJ-270X	C CAPACITOR	27pF 50V J	
C573	NCB31CK-104X	C CAPACITOR	0.1uF 16V K	
C574	NEAG0JM-107X	E CAPACITOR	100uF 6.3V M	
C575	NEAG0JM-107X	E CAPACITOR	100uF 6.3V M	
C577	NCB31CK-104X	C CAPACITOR	0.1uF 16V K	
C578	NEAG0JM-107X	E CAPACITOR	100uF 6.3V M	
C580	NCB31HK-123X	C CAPACITOR	0.012uF 50V K	

△ Symbol No.	Part No.	Part Name	Description	Local	△ Symbol No.	Part No.	Part Name	Description	Local
C581	NDC31HJ-101X	C CAPACITOR	100pF 50V J		C684	NEAG1CM-476X	E CAPACITOR	47uF 16V M	
C582	NDC31HJ-101X	C CAPACITOR	100pF 50V J		C689	NEAG1CM-476X	E CAPACITOR	47uF 16V M	
C583	NCS31HJ-821X	C CAPACITOR	820pF 50V J		C690	NBE20JM-106X	TA E CAPACITOR	10uF 6.3V M	
C584	NCS31HJ-821X	C CAPACITOR	820pF 50V J		C693	NEAG1CM-476X	E CAPACITOR	47uF 16V M	
C585	NEAG1VM-475X	E CAPACITOR	4.7uF 35V M		R501	NRSA63J-102X	MG RESISTOR	1kΩ 1/16W J	
C586	NEAG1VM-475X	E CAPACITOR	4.7uF 35V M		R502	NRSA63J-102X	MG RESISTOR	1kΩ 1/16W J	
C587	NDC31HJ-151X	C CAPACITOR	150pF 50V J		R503	NRSA63J-102X	MG RESISTOR	1kΩ 1/16W J	
C588	NDC31HJ-151X	C CAPACITOR	150pF 50V J		R504	NRSA63J-101X	MG RESISTOR	100Ω 1/16W J	
C589	NEAG1VM-475X	E CAPACITOR	4.7uF 35V M		R505	NRSA63J-101X	MG RESISTOR	100Ω 1/16W J	
C590	NEAG1VM-475X	E CAPACITOR	4.7uF 35V M		R506	NRSA63J-473X	MG RESISTOR	47kΩ 1/16W J	
C591	NEAG0JM-476X	E CAPACITOR	47uF 6.3V M		R507	NRSA63J-473X	MG RESISTOR	47kΩ 1/16W J	
C592	NEAG0JM-476X	E CAPACITOR	47uF 6.3V M		R508	NRSA63J-473X	MG RESISTOR	47kΩ 1/16W J	
C593	NEAG1CM-476X	E CAPACITOR	47uF 16V M		R509	NRSA63J-473X	MG RESISTOR	47kΩ 1/16W J	
C594	NCS31HJ-102X	C CAPACITOR	1000pF 50V J		R510	NRSA63J-101X	MG RESISTOR	100Ω 1/16W J	
C595	NCB31CK-473X	C CAPACITOR	0.047uF 16V K		R511	NRSA63J-102X	MG RESISTOR	1kΩ 1/16W J	
C596	NDC31HJ-101X	C CAPACITOR	100pF 50V J		R512	NRSA63J-473X	MG RESISTOR	47kΩ 1/16W J	
C597	NCS31HJ-102X	C CAPACITOR	1000pF 50V J		R513	NRSA63J-102X	MG RESISTOR	1kΩ 1/16W J	
C598	NCS31HJ-102X	C CAPACITOR	1000pF 50V J		R514	NRSA63J-473X	MG RESISTOR	47kΩ 1/16W J	
C601	NEAG0JM-476X	E CAPACITOR	47uF 6.3V M		R515	NRSA63J-473X	MG RESISTOR	47kΩ 1/16W J	
C602	NCB31HK-103X	C CAPACITOR	0.01uF 50V K		R516	NRSA63J-102X	MG RESISTOR	1kΩ 1/16W J	
C603	NEAG0JM-107X	E CAPACITOR	100uF 6.3V M		R517	NRSA63J-101X	MG RESISTOR	100Ω 1/16W J	
C604	NCB31HK-103X	C CAPACITOR	0.01uF 50V K		R518	NRSA63J-101X	MG RESISTOR	100Ω 1/16W J	
C605	NCB31HK-682X	C CAPACITOR	6800pF 50V K		R519	NRSA63J-101X	MG RESISTOR	100Ω 1/16W J	
C606	NEAG0JM-476X	E CAPACITOR	47uF 6.3V M		R520	NRSA63J-101X	MG RESISTOR	100Ω 1/16W J	
C607	NCB31HK-103X	C CAPACITOR	0.01uF 50V K		R521	NRSA63J-101X	MG RESISTOR	100Ω 1/16W J	
C608	NCB31CK-104X	C CAPACITOR	0.1uF 16V K		R522	NRSA63J-101X	MG RESISTOR	100Ω 1/16W J	
C609	NCB31CK-104X	C CAPACITOR	0.1uF 16V K		R523	NRSA63J-101X	MG RESISTOR	100Ω 1/16W J	
C610	NDC31HJ-5R0X	C CAPACITOR	5pF 50V J		R525	NRSA63J-104X	MG RESISTOR	100kΩ 1/16W J	
C611	NDC31HJ-680X	C CAPACITOR	68pF 50V J		R526	NRSA63J-473X	MG RESISTOR	47kΩ 1/16W J	
C612	NCB31HK-103X	C CAPACITOR	0.01uF 50V K		R528	NRSA63J-473X	MG RESISTOR	47kΩ 1/16W J	
C613	NCB31HK-103X	C CAPACITOR	0.01uF 50V K		R530	NRSA63J-473X	MG RESISTOR	47kΩ 1/16W J	
C614	NCB31HK-103X	C CAPACITOR	0.01uF 50V K		R531	NRSA63J-473X	MG RESISTOR	47kΩ 1/16W J	
C616	NBE20JM-106X	TA E CAPACITOR	10uF 6.3V M		R532	NRSA63J-102X	MG RESISTOR	1kΩ 1/16W J	
C621	NCB31HK-103X	C CAPACITOR	0.01uF 50V K		R533	NRSA63J-101X	MG RESISTOR	100Ω 1/16W J	
C622	NEAG0JM-476X	E CAPACITOR	47uF 6.3V M		R534	NRSA63J-101X	MG RESISTOR	100Ω 1/16W J	
C623	NDC31HJ-470X	C CAPACITOR	47pF 50V J		R535	NRSA63J-101X	MG RESISTOR	100Ω 1/16W J	
C624	NCB31HK-153X	C CAPACITOR	0.015uF 50V K		R536	NRSA63J-101X	MG RESISTOR	100Ω 1/16W J	
C625	NCB31HK-103X	C CAPACITOR	0.01uF 50V K		R537	NRSA63J-101X	MG RESISTOR	100Ω 1/16W J	
C626	NCB31HK-272X	C CAPACITOR	2700pF 50V K		R539	NRSA63J-473X	MG RESISTOR	47kΩ 1/16W J	
C627	NCB31HK-103X	C CAPACITOR	0.01uF 50V K		R540	NRSA63J-473X	MG RESISTOR	47kΩ 1/16W J	
C628	NEAG0JM-476X	E CAPACITOR	47uF 6.3V M		R541	NRSA63J-101X	MG RESISTOR	100Ω 1/16W J	
C629	NCB31EK-333X	C CAPACITOR	0.033uF 25V K		R542	NRSA63J-103X	MG RESISTOR	10kΩ 1/16W J	
C630	NCB31EK-333X	C CAPACITOR	0.033uF 25V K		R543	NRSA63J-101X	MG RESISTOR	100Ω 1/16W J	
C631	NDC31HJ-471X	C CAPACITOR	470pF 50V J		R544	NRSA63J-101X	MG RESISTOR	100Ω 1/16W J	
C632	NDC31HJ-471X	C CAPACITOR	470pF 50V J		R545	NRSA63J-103X	MG RESISTOR	10kΩ 1/16W J	
C633	NCB31CK-473X	C CAPACITOR	0.047uF 16V K		R546	NRSA63J-271X	MG RESISTOR	270Ω 1/16W J	
C634	NCB31CK-473X	C CAPACITOR	0.047uF 16V K		R547	NRSA63J-271X	MG RESISTOR	270Ω 1/16W J	
C635	NCB31CK-473X	C CAPACITOR	0.047uF 16V K		R548	NRSA63J-822X	MG RESISTOR	8.2kΩ 1/16W J	
C636	NCB31CK-473X	C CAPACITOR	0.047uF 16V K		R549	NRSA63J-472X	MG RESISTOR	4.7kΩ 1/16W J	
C637	NCB31CK-473X	C CAPACITOR	0.047uF 16V K		R550	NRSA63J-472X	MG RESISTOR	4.7kΩ 1/16W J	
C638	NCB31HK-103X	C CAPACITOR	0.01uF 50V K		R551	NRSA63J-104X	MG RESISTOR	100kΩ 1/16W J	
C639	NEAG0JM-476X	E CAPACITOR	47uF 6.3V M		R552	NRSA63J-104X	MG RESISTOR	100kΩ 1/16W J	
C640	NCB31HK-103X	C CAPACITOR	0.01uF 50V K		R553	NRSA63J-183X	MG RESISTOR	18kΩ 1/16W J	
C641	NEAG0JM-476X	E CAPACITOR	47uF 6.3V M		R554	NRSA63J-333X	MG RESISTOR	33kΩ 1/16W J	
C642	NDC31HJ-101X	C CAPACITOR	100pF 50V J		R555	NRSA63J-101X	MG RESISTOR	100Ω 1/16W J	
C643	NCB31HK-103X	C CAPACITOR	0.01uF 50V K		R556	NRSA63J-0R0X	MG RESISTOR	0Ω 1/16W J	
C644	NCB31AK-334X	C CAPACITOR	0.33uF 10V K		R557	NRSA63J-104X	MG RESISTOR	100kΩ 1/16W J	
C645	NEAG0JM-476X	E CAPACITOR	47uF 6.3V M		R558	NRSA63J-104X	MG RESISTOR	100kΩ 1/16W J	
C646	NCB31HK-103X	C CAPACITOR	0.01uF 50V K		R559	NRSA63J-0R0X	MG RESISTOR	0Ω 1/16W J	
C651	NEAG0JM-476X	E CAPACITOR	47uF 6.3V M		R560	NRSA63J-101X	MG RESISTOR	100Ω 1/16W J	
C652	NCB31HK-103X	C CAPACITOR	0.01uF 50V K		R561	NRSA63J-104X	MG RESISTOR	100kΩ 1/16W J	
C653	NEAG0JM-476X	E CAPACITOR	47uF 6.3V M		R562	NRSA63J-392X	MG RESISTOR	3.9kΩ 1/16W J	
C654	NCB31CK-104X	C CAPACITOR	0.1uF 16V K		R563	NRSA63J-682X	MG RESISTOR	6.8kΩ 1/16W J	
C655	NCB31HK-103X	C CAPACITOR	0.01uF 50V K		R568	NRSA63J-102X	MG RESISTOR	1kΩ 1/16W J	
C656	NCB31CK-104X	C CAPACITOR	0.1uF 16V K		R569	NRSA63J-102X	MG RESISTOR	1kΩ 1/16W J	
C659	NCB31CK-104X	C CAPACITOR	0.1uF 16V K		R570	NRSA63J-102X	MG RESISTOR	1kΩ 1/16W J	
C660	NDC31HJ-101X	C CAPACITOR	100pF 50V J		R572	NRSA63J-225X	MG RESISTOR	2.2MΩ 1/16W J	
C661	NCB31HK-103X	C CAPACITOR	0.01uF 50V K		R573	NRSA63J-102X	MG RESISTOR	1kΩ 1/16W J	
C662	NDC31HJ-101X	C CAPACITOR	100pF 50V J		R574	NRSA63J-470X	MG RESISTOR	47Ω 1/16W J	
C663	NBE20JM-106X	TA E CAPACITOR	10uF 6.3V M		R575	NRSA63J-102X	MG RESISTOR	1kΩ 1/16W J	
C664	NCB31HK-222X	C CAPACITOR	2200pF 50V K		R576	NRSA63J-102X	MG RESISTOR	1kΩ 1/16W J	
C665	NCB31CK-104X	C CAPACITOR	0.1uF 16V K		R577	NRSA63J-101X	MG RESISTOR	100Ω 1/16W J	
C666	NDC31HJ-101X	C CAPACITOR	100pF 50V J		R578	NRSA63J-473X	MG RESISTOR	47kΩ 1/16W J	
C667	NCB31HK-103X	C CAPACITOR	0.01uF 50V K		R579	NRSA63J-222X	MG RESISTOR	2.2kΩ 1/16W J	
C668	NEAG0JM-476X	E CAPACITOR	47uF 6.3V M		R581	NRSA63J-243X	MG RESISTOR	24kΩ 1/16W J	
C669	NCB31HK-103X	C CAPACITOR	0.01uF 50V K		R582	NRSA63J-243X	MG RESISTOR	24kΩ 1/16W J	
C682	NEAG1VM-475X	E CAPACITOR	4.7uF 35V M		R583	NRSA63J-822X	MG RESISTOR	8.2kΩ 1/16W J	
C683	NCB31CK-104X	C CAPACITOR	0.1uF 16V K						

△ Symbol No.	Part No.	Part Name	Description	Local	△ Symbol No.	Part No.	Part Name	Description	Local
R584	NRSA63J-822X	MG RESISTOR	8.2kΩ 1/16W J		CN501	QGB2027L1-22X	CONNECTOR	B-B (1-22)	
R585	NRSA63J-273X	MG RESISTOR	27kΩ 1/16W J		CN601	QGF0501F8-22X	CONNECTOR	FFC/FPC (1-22)	
R586	NRSA63J-273X	MG RESISTOR	27kΩ 1/16W J		TH501	NAD0028-103X	N THERMISTOR	10kΩ	
R587	NRSA63J-473X	MG RESISTOR	47kΩ 1/16W J		X501	NAX0385-001X	CRYSTAL	24.576MHz	
R588	NRSA63J-473X	MG RESISTOR	47kΩ 1/16W J		X571	NAX0375-001X	CRYSTAL	16.9344MHz	
R589	NRSA63J-103X	MG RESISTOR	10kΩ 1/16W J		<h3 style="text-align: center;">Cassette mechanism control board (KW-XC407_EE)</h3> <p style="text-align: right;">Block No. [1][0]</p>				
R590	NRSA63J-103X	MG RESISTOR	10kΩ 1/16W J						
R591	NRSA63J-103X	MG RESISTOR	10kΩ 1/16W J						
R592	NRSA63J-103X	MG RESISTOR	10kΩ 1/16W J						
R593	NRSA63J-4R7X	MG RESISTOR	4.7Ω 1/16W J						
R594	NRSA63J-470X	MG RESISTOR	47Ω 1/16W J						
R595	NRSA63J-470X	MG RESISTOR	47Ω 1/16W J						
R601	NRSA63J-823X	MG RESISTOR	82kΩ 1/16W J						
R602	NRSA63J-823X	MG RESISTOR	82kΩ 1/16W J						
R603	NRSA63J-334X	MG RESISTOR	330kΩ 1/16W J						
R604	NRSA63J-334X	MG RESISTOR	330kΩ 1/16W J						
R605	NRSA63J-220X	MG RESISTOR	22Ω 1/16W J						
R606	NRSA63J-220X	MG RESISTOR	22Ω 1/16W J						
R607	NRSA63J-823X	MG RESISTOR	82kΩ 1/16W J						
R608	NRSA63J-821X	MG RESISTOR	820Ω 1/16W J						
R609	NRSA63J-563X	MG RESISTOR	56kΩ 1/16W J						
R610	NRSA63J-101X	MG RESISTOR	100Ω 1/16W J						
R611	NRSA63J-103X	MG RESISTOR	10kΩ 1/16W J						
R612	NRSA63J-202X	MG RESISTOR	2kΩ 1/16W J						
R613	NRSA63J-102X	MG RESISTOR	1kΩ 1/16W J						
R614	NRSA63J-153X	MG RESISTOR	15kΩ 1/16W J						
R615	NRSA63J-151X	MG RESISTOR	150Ω 1/16W J						
R616	NRSA63J-103X	MG RESISTOR	10kΩ 1/16W J						
R621	NRSA63J-470X	MG RESISTOR	47Ω 1/16W J						
R622	NRSA63J-470X	MG RESISTOR	47Ω 1/16W J						
R623	NRSA63J-470X	MG RESISTOR	47Ω 1/16W J						
R624	NRSA63J-562X	MG RESISTOR	5.6kΩ 1/16W J						
R625	NRSA63J-473X	MG RESISTOR	47kΩ 1/16W J						
R626	NRSA63J-474X	MG RESISTOR	470kΩ 1/16W J						
R627	NRSA63J-153X	MG RESISTOR	15kΩ 1/16W J						
R628	NRSA63J-155X	MG RESISTOR	1.5MΩ 1/16W J						
R629	NRSA63J-103X	MG RESISTOR	10kΩ 1/16W J						
R630	NRSA63J-101X	MG RESISTOR	100Ω 1/16W J						
R631	NRSA63J-101X	MG RESISTOR	100Ω 1/16W J						
R632	NRSA63J-0R0X	MG RESISTOR	0Ω 1/16W J						
R633	NRSA63J-0R0X	MG RESISTOR	0Ω 1/16W J						
R634	NRSA63J-0R0X	MG RESISTOR	0Ω 1/16W J						
R635	NRSA63J-101X	MG RESISTOR	100Ω 1/16W J						
R636	NRSA63J-101X	MG RESISTOR	100Ω 1/16W J						
R637	NRSA63J-105X	MG RESISTOR	1MΩ 1/16W J						
R638	NRSA63J-472X	MG RESISTOR	4.7kΩ 1/16W J						
R639	NRSA63J-472X	MG RESISTOR	4.7kΩ 1/16W J						
R640	NRSA63J-472X	MG RESISTOR	4.7kΩ 1/16W J						
R641	NRSA63J-472X	MG RESISTOR	4.7kΩ 1/16W J						
R642	NRSA63J-103X	MG RESISTOR	10kΩ 1/16W J						
R651	NRSA63J-104X	MG RESISTOR	100kΩ 1/16W J						
R654	NRSA63J-390X	MG RESISTOR	39Ω 1/16W J						
R655	NRSA63J-103X	MG RESISTOR	10kΩ 1/16W J						
R656	NRSA63J-473X	MG RESISTOR	47kΩ 1/16W J						
R657	NRSA63J-222X	MG RESISTOR	2.2kΩ 1/16W J						
R668	NRSA63J-470X	MG RESISTOR	47Ω 1/16W J						
R675	NRSA63J-221X	MG RESISTOR	220Ω 1/16W J						
R681	NRSA63J-682X	MG RESISTOR	6.8kΩ 1/16W J						
R682	NRSA63J-222X	MG RESISTOR	2.2kΩ 1/16W J						
R683	NRSA63J-682X	MG RESISTOR	6.8kΩ 1/16W J						
R684	NRSA63J-822X	MG RESISTOR	8.2kΩ 1/16W J						
R685	NRSA63J-682X	MG RESISTOR	6.8kΩ 1/16W J						
R686	NRSA63J-123X	MG RESISTOR	12kΩ 1/16W J						
R687	NRSA63J-682X	MG RESISTOR	6.8kΩ 1/16W J						
R688	NRSA63J-182X	MG RESISTOR	1.8kΩ 1/16W J						
R689	NRSA63J-123X	MG RESISTOR	12kΩ 1/16W J						
R690	NRSA63J-333X	MG RESISTOR	33kΩ 1/16W J						
R691	NRSA63J-153X	MG RESISTOR	15kΩ 1/16W J						
L501	NQL114K-470X	COIL	47uH K		R401	NRS181J-681X	MG RESISTOR	680Ω 1/8W J	
L502	NQL114K-470X	COIL	47uH K		R402	NRSA63J-104X	MG RESISTOR	100kΩ 1/16W J	
L572	NQL114K-470X	COIL	47uH K		R403	NRSA63J-104X	MG RESISTOR	100kΩ 1/16W J	
L621	NQL114K-470X	COIL	47uH K		R404	NRSA63J-104X	MG RESISTOR	100kΩ 1/16W J	
L622	NQL114K-470X	COIL	47uH K		R405	NRSA63J-104X	MG RESISTOR	100kΩ 1/16W J	
L623	NQL114K-470X	COIL	47uH K		R406	NRSA63J-181X	MG RESISTOR	180Ω 1/16W J	
L651	NQL114K-470X	COIL	47uH K		R407	NRSA63J-181X	MG RESISTOR	180Ω 1/16W J	
L652	NQL114K-470X	COIL	47uH K		R412	NRSA63J-101X	MG RESISTOR	100Ω 1/16W J	
L653	NQL114K-470X	COIL	47uH K		R413	NRSA63J-183X	MG RESISTOR	18kΩ 1/16W J	

Symbol No.	Part No.	Part Name	Description	Local
R414	NRSA63J-392X	MG RESISTOR	3.9kΩ 1/16W J	
R415	NRSA63J-223X	MG RESISTOR	22kΩ 1/16W J	
R416	NRSA63J-155X	MG RESISTOR	1.5MΩ 1/16W J	
R417	NRSA63J-103X	MG RESISTOR	10kΩ 1/16W J	
R418	NRSA63J-153X	MG RESISTOR	15kΩ 1/16W J	
R422	NRSA63J-332X	MG RESISTOR	3.3kΩ 1/16W J	
R423	NRSA63J-473X	MG RESISTOR	47kΩ 1/16W J	
R424	NRSA63J-222X	MG RESISTOR	2.2kΩ 1/16W J	
R425	NRSA63J-680X	MG RESISTOR	68Ω 1/16W J	
R426	NRSA63J-680X	MG RESISTOR	68Ω 1/16W J	
R432	NRSA63J-473X	MG RESISTOR	47kΩ 1/16W J	
R433	NRSA63J-473X	MG RESISTOR	47kΩ 1/16W J	
R435	NRSA63J-473X	MG RESISTOR	47kΩ 1/16W J	
R437	NRSA63J-473X	MG RESISTOR	47kΩ 1/16W J	
R438	NRSA63J-473X	MG RESISTOR	47kΩ 1/16W J	
R439	NRSA63J-473X	MG RESISTOR	47kΩ 1/16W J	
R440	NRSA63J-473X	MG RESISTOR	47kΩ 1/16W J	
R441	NRSA63J-473X	MG RESISTOR	47kΩ 1/16W J	
R442	NRSA63J-473X	MG RESISTOR	47kΩ 1/16W J	
R443	NRSA63J-222X	MG RESISTOR	2.2kΩ 1/16W J	
R444	NRSA63J-473X	MG RESISTOR	47kΩ 1/16W J	
R445	NRSA63J-563X	MG RESISTOR	56kΩ 1/16W J	
R446	NRSA63J-473X	MG RESISTOR	47kΩ 1/16W J	
R447	NRSA63J-473X	MG RESISTOR	47kΩ 1/16W J	
R448	NRSA63J-683X	MG RESISTOR	68kΩ 1/16W J	
R449	NRSA63J-103X	MG RESISTOR	10kΩ 1/16W J	
R450	NRSA63J-473X	MG RESISTOR	47kΩ 1/16W J	
R451	NRSA63J-473X	MG RESISTOR	47kΩ 1/16W J	
R454	NRSA63J-473X	MG RESISTOR	47kΩ 1/16W J	
R455	NRSA63J-102X	MG RESISTOR	1kΩ 1/16W J	
R456	NRSA63J-102X	MG RESISTOR	1kΩ 1/16W J	
R457	NRSA63J-102X	MG RESISTOR	1kΩ 1/16W J	
R458	NRSA63J-102X	MG RESISTOR	1kΩ 1/16W J	
R461	NRSA63J-223X	MG RESISTOR	22kΩ 1/16W J	
R462	NRSA63J-334X	MG RESISTOR	330kΩ 1/16W J	
R463	NRSA63J-101X	MG RESISTOR	100Ω 1/16W J	
R464	NRSA63J-104X	MG RESISTOR	100kΩ 1/16W J	
R465	NRSA63J-223X	MG RESISTOR	22kΩ 1/16W J	
R466	NRSA63J-104X	MG RESISTOR	100kΩ 1/16W J	
R467	NRSA63J-103X	MG RESISTOR	10kΩ 1/16W J	
R468	NRSA63J-331X	MG RESISTOR	330Ω 1/16W J	
R469	NRSA63J-223X	MG RESISTOR	22kΩ 1/16W J	
R470	NRSA63J-101X	MG RESISTOR	100Ω 1/16W J	
R471	NRSA63J-334X	MG RESISTOR	330kΩ 1/16W J	
R491	NRSA63J-0R0X	MG RESISTOR	0Ω 1/16W J	
VR401	QVP0033-333Z	TRIM RESISTOR	33kΩ	
VR402	QVP0033-333Z	TRIM RESISTOR	33kΩ	
L431	NQL114K-470X	COIL	47uH K	
CN401	QGB1004K1-16	CONNECTOR	B-B (1-16)	
CN402	QGA2001F1-06	CONNECTOR	W-B (1-6)	
CN403	QGF1205C2-10	CONNECTOR	FFC/FPC (1-10)	
X431	QAX0414-001Z	CRYSTAL	4.19430MHz	

**<MEMO>**

# Packing materials and accessories parts list

Block No. **M 3 M M**

No additional / supplemental order of WARRANTY CARDS are available.

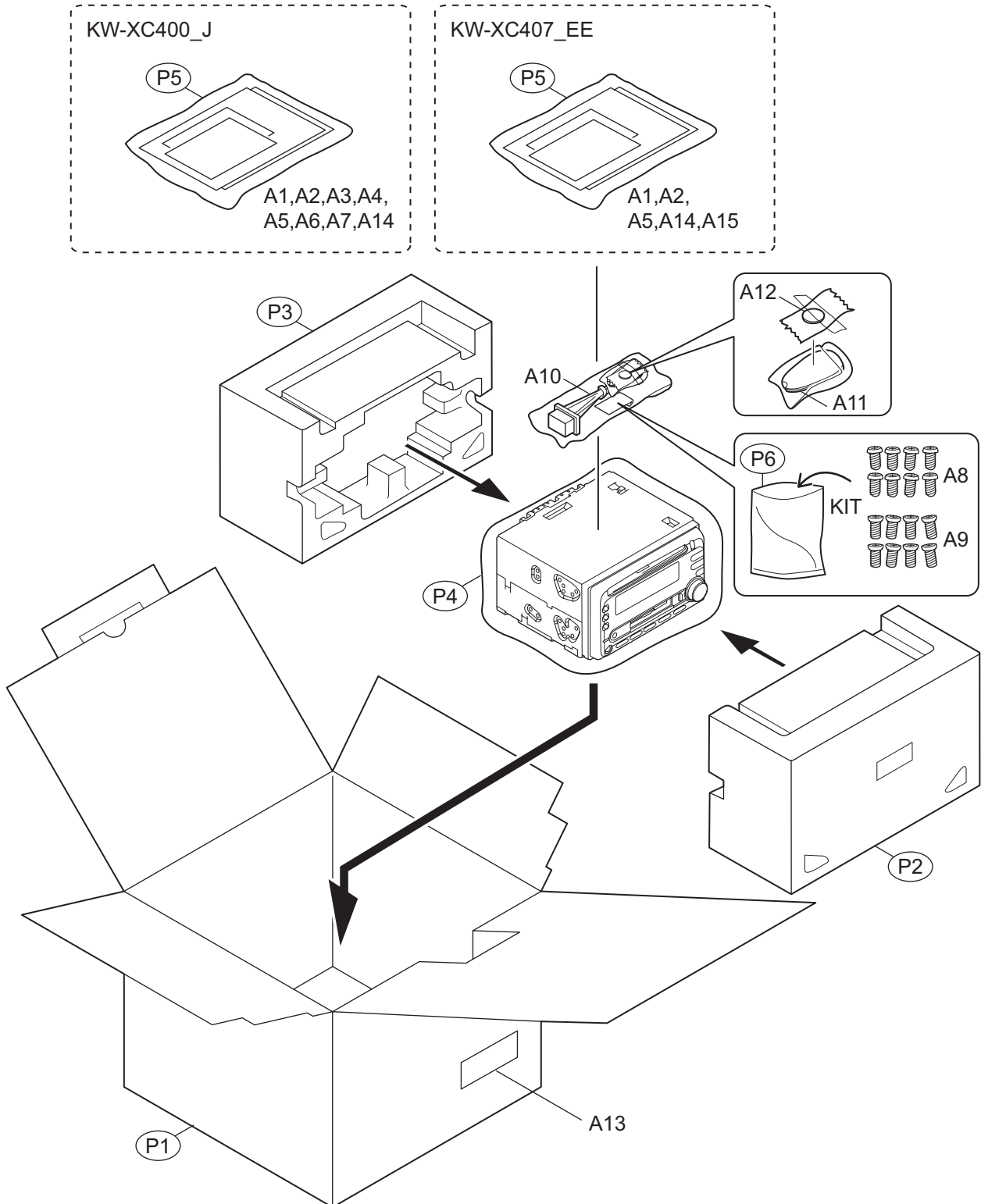



# Packing and Accessories

Block No. [M][3][M][M]

△	Symbol No.	Part No.	Part Name	Description	Local
	A 1	GET0320-001B	INST BOOK	ENG FRE SPA	400J
	A 1	GET0329-001A	INST BOOK	ENG RUS	407EE
	A 2	GET0320-002B	INST.MANUAL		400J
	A 2	GET0329-002A	INST.MANUAL		407EE
	A 3	LVT0717-001B	TROUBLE SHEET(C		400J
	A 4	LVT0717-002B	TROUBLE SHOOTIN		400J
	A 5	-----	WARRANTY CARD	BT-52006-2	400J
	A 5	-----	WARRANTY CARD	BT-54027-1	407EE
	A 6	-----	WARRANTY CARD	BT-51018-4	400J
	A 7	BT-51034-2	REGISTRATION CARD		400J
	A 8	QYSDSP5008ZA	SCREW	M5 x 8mm(x8)	
	A 9	QYSSSP5008ZA	SCREW	M5 x 8mm(x8)	
△	A 10	QAM0306-002	POWER CORD		400J
△	A 10	QAM0569-002	POWER CORD		407EE
	A 11	RM-RK50C	REMOCON		
	A 12	-----	BATTERY		
	A 13	LV33728-001A	CARTON LABEL		
	A 14	VJC3300-001SS	BLIND PLATE		
	A 15	VND3046-001	SERIAL TICKET		407EE
	KIT	SRW-KW400J	SCREW PARTS KIT	A8 A9	
	P 1	GE32002-002A	CARTON		400J
	P 1	GE32004-003A	CARTON		407EE
	P 2	LV10524-003A	CUSHION FRONT		
	P 3	LV10525-003A	CUSHION (REAR)		
	P 4	QPC03004315P	POLY BAG	30cm x 43cm	
	P 5	FSPG4002-001	POLY BAG		
	P 6	QPA00801205	POLY BAG	8cm x 12cm	